

OVER 230,000 COPIES OF THIS ISSUE PRINTED AND DISTRIBUTED

# RADIO NEWS

REG. U.S. PAT. OFF.

*July*  
25 Cents  
November  
1923

Over 200 Illustrations

Edited by H. GERNSBACK

## AMATEUR NUMBER

### IN THIS ISSUE

John L. Reinartz, 1QP  
A. L. Groves, 3BID  
Leon Bishop, 1XP  
Ralph R. Batcher  
Howard S. Pyle  
K. M. Swezey



THE AUTOPLEX CIRCUIT

THE 100% WIRELESS MAGAZINE

CIRCULATION LARGER THAN ANY OTHER RADIO PUBLICATION



## It Bridges the Vastness of Space

**S**INCE Marconi first successfully spanned the Atlantic Ocean, with the wireless telegraph, radio has ever been outstanding as an invention of unlimited importance to humanity.

In 1909 the broadcasting of that now famous distress call, CQD, from the sinking passenger liner, S. S. Republic, established in the eyes of the entire world the tremendous importance of radio on the high seas.

In 1912, when that gigantic liner, the S. S. Titanic, struck an iceberg far from shore, in the north Atlantic, with thousands of passengers aboard, it was the SOS call of her wireless that brought rescue ships from all parts of the ocean. Here again radio demonstrated to the world its great service in the saving of human life.

During the war communication controlled the destinies of armies. Here radio played an exclusive part in the establishing of communication between ships at sea, from ship to shore, and from aeroplane to ground, where the use of wires was impossible.

In recent years the development of the vacuum tube has not only improved radio for the purpose of marine, commercial and military communications, but through radio telephony and public broadcasting, has established a new and even greater service to humanity.

Cunningham Vacuum Tubes are the product of years of research and experimental work by the Engineers of that great scientific organization, the Research Laboratory of the General Electric Company.

Cunningham Tubes are standard for all makes of receiving sets. Each of the numerous types have been designed to operate with maximum efficiency in one or more of the various applications of vacuum tubes to the radio art.

*A Specially  
Designed Tube  
For Every  
Radio Use*

Cunningham Radio Tubes	
C-301A—6 Volts ¼ amp. Amp. ....	\$6.50
C-299—3 Volts .06 amp. Dry Battery Det. & Amp. ....	6.50
C-300—6 Volts Gas Content Detector. ....	5.00
C-11—1.1 Volts .25 amp. Dry Battery Det. and Amp. Special Base. ....	6.50
C-12—Similar to C-11 with standard base..	6.50

**Patent Notice:** Cunningham tubes are covered by patents dated 11-7-05, 1-15-07, 2-18-08, and others issued and pending. Licensed for amateur, experimental and entertainment use in radio communication. Any other use will be an infringement.

*E. J. Cunningham Inc.*



**Home Office:**  
248 First Street  
San Francisco, Calif.

154 West Lake Street  
Chicago, Illinois

30 Church Street  
New York City, N. Y.

# AMPLION



England

Canada

Scotland

Australia

Wales

New Zealand

Ireland

So. Africa

Norway

India

Sweden

France

Denmark

Italy

Holland

Spain

Belgium

Japan

WITH the Amplion Loud Speaker the infinite clearness and softness of tone achieves an unsurpassed reproduction welcomed and admired everywhere. The human voice or musical sounds come to you in their true richness, without the slightest distortion, unalloyed—just as they are rendered.

It is hard to believe you are listening to reproduction. Originality is so unmistakably registered in every tone.

The Amplion is made by the world's oldest manufacturer of loud speaking instruments. It is not a head set receiver used as a loud speaker, but a development for radio purposes of a loud speaking device, used exclusively on every ship of the British and other leading navies.

The Amplion requires no battery. You simply attach it in place of head phones. The Amplion is being extensively used in every country mentioned in the border of this announcement.

That it has been adopted as standard by the leading countries of the world is the tribute it has achieved through its brilliant performance.

All models on view at the New York Radio Exposition, Booth 5, at the New York Show—Oct. 6th to 13th.

**SIGNAL ELECTRIC MFG. CO.**

*Sole United States Distributors*

Menominee, Michigan

**BURNDEPT OF CANADA, LTD.**

*Canadian Distributors*

172 King St., West, Toronto

*The Supremacy of the AMPLION  
is the Supremacy  
of Actual Performance*

# RADIO NEWS



## CONTENTS

VOL. 5

FOR NOVEMBER

No. 5

	Page		Page
Editorial .....	521	The Amateur's Huge Gain from Broadcasting, By I. R. Tannehill	541
The Nerve System of the Sea....	522	The Autoplex Circuit.....	542
Eliminating Static With the Resonance Wave Coil.....	523	Pointers for the New Amateurs, By A. L. Groves, 3B1D	544
What Uncle Sam is Doing for the Amateur, By S. R. Winters	524	Radio Entertains Boy Scouts at Camp Glen Gray .....	546
Electrons, Electric Waves and Wireless Tele- phony—Part X .....	526	Station 2BGM, New York City .....	547
It's Great to be One of 'Em, By Edward T. Jones	527	Edward M. Glaser's Station, 2BRB.....	547
Awards of the Reflex Prize Contest .....	528	V. M. Bütz's Station, 6JD .....	548
100-Meter C. W. Transmission..	530	My Moduloscope ....	549
The Amateur to the Rescue of the BCL, By Kenneth M. Swezey	531	High Frequency Resistance ..	550
A Low Power C.W. Set, By R. P. Ballou, 9CAR	532	Design of an Audibility Meter, By Ralph R. Batcher	552
A 10-Watt C.W. Set....	532	Loop Antennae for Transmission, By Allan R. Kenworthy	553
A One-Tube Receiver That Brings Them In, By Leon W. Bishop, 1XP	533	Antenna Counterpoise Safety Switch, By Howard S. Pyle	553
Some Power Considerations in Radio Transmis- sion .....	534	Vacuum Tubes for Amateurs..	554
Everyday Observations of the Beat Phenomenon, By W. Palmer Powers	535	A Voltage Raiser for C.W. Transmitters, By Marcus G. Scroggie, English 5JX	556
The Amateur Traffic Problem, By Howard S. Pyle	536	The Static Frequency Multiplier, By Marius Latour	557
Silent Code Will Reduce Interference, By S. R. Winters	537	Continuous Wave and Radiophone Transmitters— Part II .....	558
State College to Teach Radio by Correspondence	537	Radio Frequency Transformers, By Clyde J. Fitch	559
Radio in the Professional Field .....	538	A High Frequency Alternator for Tone Modula- tion .....	560
Amateur Radio in the Orient, By Roy A. Anderson	538	Throw Those Taps Away, By Bert T. Bonaventure	560
Carl W. Klenk's Station, 9AAU.....	539	New Radio Patents .....	561
J. R. Watson's Station, 3JV.....	539	Radio News Laboratories .....	562
The Great Radio Message from Mars, By Ellis Parker Butler	540	Correspondence from Readers .....	564
		I-Want-to-Know .....	565

Index to Advertisers .....

508

RADIO NEWS is published on the 10th of each month. There are 12 numbers per year. Subscription price is \$2.50 a year in U. S. and possessions. Canada and foreign countries, \$3.00 a year. U. S. coin as well as U. S. Stamps accepted (no foreign coins or stamps). Single copies, 25 cents each. A sample copy will be sent gratis on request. Checks and money orders should be drawn to order of EXPERIMENTER PUBLISHING CO., INC. If you should change your address notify us promptly, in order that copies be not miscarried or lost. No copies sent after expiration.

All communications and contributions to this journal should be addressed to Editor, RADIO NEWS, 842 Jamaica Avenue, Jamaica, New York; or 53 Park Place, New York, N. Y. Unaccepted contributions cannot be returned unless full postage has been included. All accepted contributions

General Advertising Dept., 53 Park Place, New York City. Western Advertising Representatives, Finucan & McClure, 720 Cass Street, Chicago, Ill. Kansas City Representative, Geo. F. Dillon, Republic Bldg., Kansas City, Mo. Pacific Coast Advertising Representatives, A. J. Norris Hill Co., Hearst Bldg., San Francisco, Cal.

Published by EXPERIMENTER PUBLISHING CO., INC.  
 Publishers of "Radio News," "Science and Invention" and "Practical Electrics."  
 Publication Office: Jamaica, N. Y. Editorial and General Offices: 53 Park Place, New York City  
 H. GERNSBACK, President S. GERNSBACK, Treasurer R. W. DEMOTT, Secretary

are part of our publication. A special rate is paid for novel experiments good photographs accompanying them are highly desirable.

RADIO NEWS Monthly. Entered as second-class matter at the Post Office at Jamaica, N. Y., under the act of March 3, 1897. Title registered U. S. Patent Office. Copyright, 1921, by E. P. Co., Inc., New York. The Experimenter Publishing Co., 53 Park Place, N. Y. The Contents of this magazine are copyrighted and must not be reproduced without giving full credit to the publication.

RADIO NEWS is for sale at all newsstands in the United States and Canada; also at The International News Co., Ltd., Bream's Building, London E. C. 4, England, and at Brentano's 37 Avenue de l'Opera, Paris.

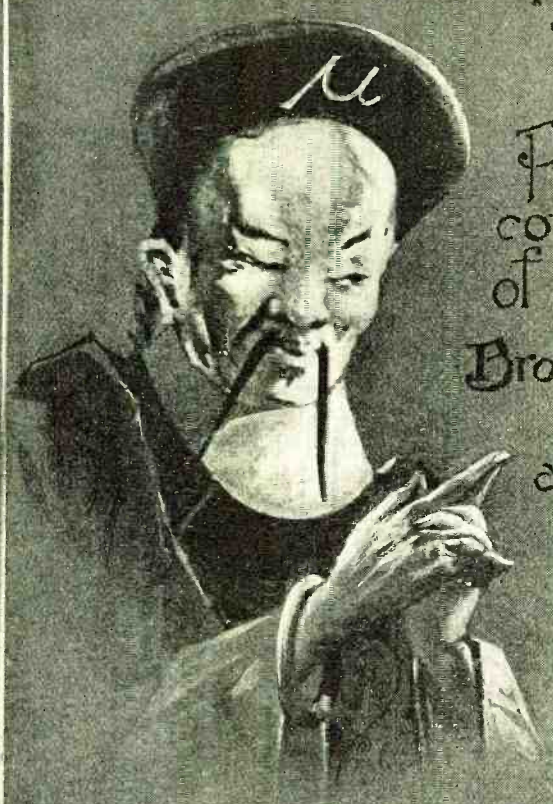

"The Wise are free from perplexities."  
Confucius

Perplexity never comes to the owner of a **GREBE** Broadcast Receiver. he is truly a Wise man  
Doctor My.



**T**HE 20-foot silk-covered wire, supplied with this Receiver, is the only antenna required. You may conceal this wire behind the picture moulding, or run it along the baseboard of your favorite room.

The attractively finished walnut cabinet has compartments for all necessary batteries.

Write for "GREBE Radio in the Well-appointed Home"

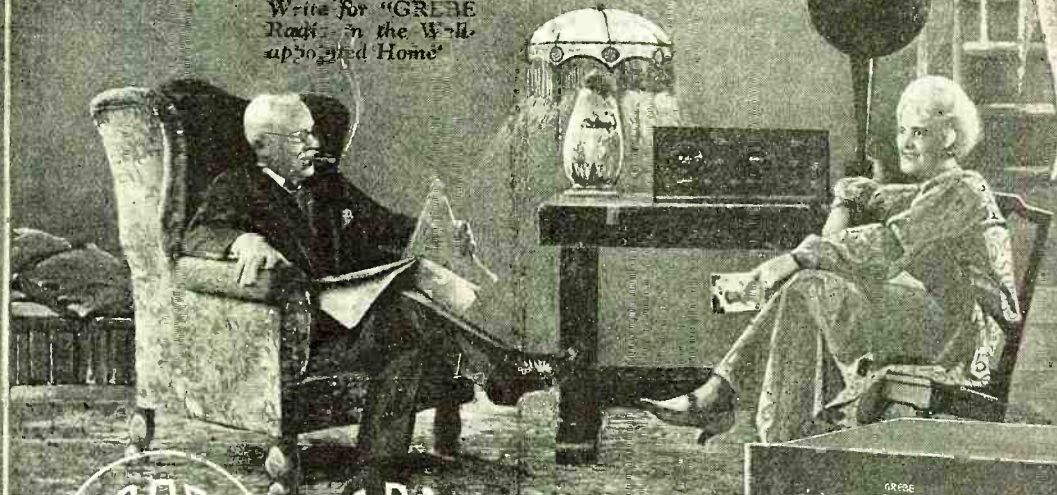

Licensed Under Copyright U. S. Pat. No. 1,113,449



GREBE & COMPANY, Inc. Richmond Hill, N.Y.  
Western Branch—45 East 3rd St., Los Angeles, Cal

# Index to Advertisers

A		D		Page		Page	
Acme Apparatus Company.....	567	Daniel, R. W. ....	634	Kennedy Co., The Colin B., 510,	511	Radio Improvement Co., Inc.,	611
Aitken Radio Company.....	608	Daven Radio Company.....	643	Kennington Radio Supply Company .....	628	Radio Industries Corp.....	609
Alden Manufacturing Com- pany .....	606	Dayton Fan & Motor Com- pany .....	627	Kilbourne & Clark Mfg. Com- pany .....	640	Radio Institute of America...	574
Allen-Bradley Company .....	664	Delta Electric Company.....	616	Killoch Company, David.....	632	Radio Mfg. Company, The....	644
American Electrical Heater Company .....	584	Diamond State Fibre Com- pany .....	593	Kimley Electric Company, Inc.	642	Radio Print .....	578
American Radio Stores .....	625	Dobbins, Ray .....	652	Klaus Radio & Electric Com- pany .....	572	Radio Products Mfg. Co.....	606
American Hard Rubber Com- pany .....	617	Dodge's Institute .....	644	Klosner Improved Apparatus Company .....	622	Radio Research Guild .....	638
American Specialty Company, The .....	628	Dodge Radio Short Cut.....	631	L		Radio Research Laboratories..	594
American Transformer Com- pany .....	614	Douglas Shoe Company, W. L.	654	Lambert, Leon .....	631	Radio Specialty Company....	603
Amsterdam Service Exchange.	576	Dubilier Radio & Condenser Corporation .....	613	Lancaster & Allwine .....	651	Radio Stores Corporation....	520
Anchor Co., The .....	643	Duck Company, The Wm. B..	582	LeFax, Inc. ....	592	Radio Tube Exchange.....	621
Andrae & Sons Co., Julius...	572	Durkee-Thomas Products Com- pany .....	646	Leich Electric Company.....	586	Radio Units, Inc. ....	626
Andrea, Inc., F. A. D.....	644	E		M		Randel Wireless Co.....	652
Atwater Kent Mfg. Company.	615	E. I. Company, The, Inside Back Cove:		M. P. M. Sales Company....	624	Randolph & Company.....	651
Atwood Electric Company .....	646	Electrical Research Labs....	573	Magnavox Co., The .....	587	Rasla Sales Corporation....	574
Automatic Electrical Devices Company, The .....	643	Electric Specialty Co. ....	663	Marko Storage Battery Co... 616	623	Rauland Mfg. Co. ....	627
Autoyre Company, The.....	644	Electric Storage Battery Com- pany, The .....	562	Marshall-Gerkin Co., The .....	623	Regent Specialties, Inc. ....	657
B		Engravers & Printers Machin- ery Co. ....	610	Martin-Copeland Co. ....	583	Remler Radio Mfg. Co.....	612
Bakelite Corporation .....	633	Erisman Labs., The.....	572	Marvel-Switch Company .....	572	Rhamstine, J. Thos.....	608
Baldwin, Inc., Nathaniel....	629	Evans & Co., Victor J.....	651	Massachusetts Radio & Tele- graph School, Inc.....	638	Riggs Mfg. Co., The.....	636
Bannerman Sons, Francis....	652	Experimenters Information Ser- vice .....	589	Michigan Radio Corporation..	645	Rose Radio Supply .....	606
Barawik Company, The...514,	315	F		Midwest Radio Co. ....	625	Rusonite Products Corp....	637
Beckley-Ralston Co., The .....	661	Fahnestock Electric Company.	637	Mitchell Blair Co. ....	625	S	
Benham, E. W. ....	636	Fanstee! Products Co., Inc... 655		Model's .....	659	Sadler Mfg. Co. ....	629
Bergen Radio Supply Com- pany .....	636	Federal Telephone & Tele- graph Company .....	624	Montgomery Ward & Co.....	577	Samson Electric Co. ....	635
Bierman Everett Foundry Company .....	638	Ferbend Electric Co.....	578	Montrose Mfg. Company....	618	Saturn Mfg. & Sales Co., Inc., The .....	610
Bogue, B. N. ....	652	Fischer & Co., G. H.....	650	Morrison Laboratories, Inc... 642	490	Sectron Radio Company, The.	649
Boice, W. & J. ....	635	Forman & Co. ....	644	Morton, A. M. ....	490	Service Battery Co.....	641
Box 140 .....	634	Formica Insulation Company, The .....	579	Moss-Schury Mfg. Co., Inc... 645	653	Service Radio Company....	622
Box 233 .....	657	France Mfg. Co., The.....	636	Multiple Electric Products Co. 653	661	Shipman-Ward Mfg. Co.....	656
Boys' Life .....	654	Freed-Esleman Radio Corpora- tion .....	578	MuRad Laboratories, Inc. 588,	661	Sidbenel Radio Equipment Mfg. Co. ....	604
Brach Mfg. Company, L. S..	642	Freshman Co., Inc., Chas., 646, 650, 573	573	N		Signal Electric Mfg. Co.....	505
Brandes, Inc., C. ....	651	Frost, Inc., Herbert H., 518, 519,	582	Nassau Radio Co.....	634	Southern Toy Co., The.....	628
Branson, Inc., Chas. A .....	594	G		National Airphone Corpora- tion .....	598, 599	Steinmetz Wireless Mfg. Co...	586
Bremer-Tully Mfg. Company.	574	General Electric Company....	639	National Carbon Company, Inc. ....	575	Stromberg-Carlson Telephone Mfg. Co. ....	650
Bristol Company, The.....	618	General Radio Company.....	650	National Chelsea Radio Corpo- ration .....	596	T	
Brockway Laboratories Co..	630	General Radio Corporation....	631	National Radio Institute....	509	Telephone Maintenance Com- pany .....	622
Brown & Co., Thos.....	623	Giffillan Bros., Inc. ....	591	National Transformer Mfg. Company .....	656	Tower Mfg. Company.....	631
Brownlie, Roland .....	584	Goodell-Pratt Company .....	652	Nazeley Co., J. ....	640	Tresco .....	612
Bureau of Inventive Science..	642	Gould Storage Battery Com- pany .....	631	Newman-Stern Co., The.....	576	Tri-State Radio Sales Co....	640
Butler Mfg. Company .....	652	Great Lakes Radio Company..	571	New York Coil Co. ....	657	Trimm Radio Mfg. Company	640
C		Grebe & Co., Inc., A. H.....	507	N. Y. Institute of Photography	638	Tuska Company, The C. D..	595
Caldbeck Tool & Mfg. Co....	646	Guarantee Sales Co. ....	632	North-Western School, The...	646	Twitcheil, S. A. ....	628
California Trading Company..	656	H		Novo Mfg. Company .....	614	U	
Carson, C. E. ....	644	H & H Radio Company.....	620	O'Brien, Clarence A.....	646	U. S. Tool Company, Inc....	610
Carter Radio Company.....	614, 636	Hanes-Zener Company.....	653	Omnigraph Mfg. Co., The....	592	Union Construction Co. ....	606
Central Radio Laboratories ..	618	Harvard Radio Laboratory...	588	Owen, Richard B. ....	656	Union Radio Corporation....	570
Chaslyn Co. ....	640	Hayden Radio & Research Corporation, A. C. ....	574	Ozment, C. J. ....	651	United Mfg. & Distributing Co.	630
Chemical Institute of New York, Inc. ....	601	Heath Radio & Electric Mfg. Company .....	632	P		United Y. M. C. A. Radio Schools .....	596
Chicago Salvage Stock Store.	597	Hesslein, William .....	612	Pacent Electric Co. ....	631	V	
Clapp-Eastham Company .....	590	Holtzer-Cabot Electric Com- pany, The .....	637	Parker, C. L. ....	646	V-De-Co Radio Mfg. Co.....	652
Clearstone Radio Company, Inc. The .....	626	Home Supply Company.....	621	Pathé Phonograph & Radio Corp. ....	580, 641	Valley Electric Co. ....	576
Columbia Radio Corporation..	632	Hommel & Co., Ludwig.....	576	Personal Service Purchasing Bureau .....	616	Veritas, M. ....	642
Connecticut Tel. & Electric Company .....	620	Hudson-Ross .....	582	Pioneer Radio Corp.....	608	Vesco Radio Shop .....	610
Consrud Company, Inc., The 600,	658	Hygrade Electrical Novelty Company .....	645	Porell Company, Inc., George H. ....	612	W	
Continental Fibre Company, The .....	638	I		Precision Equipment Co., The 612	612	Waits, E. F. ....	640
Continental Radio & Electric Corporation .....	614	Illinois Radio Company.....	636	Press Co., The .....	612	Walker Company, Inc., G. E.	652
Copper Clad Steel Company..	594	International Correspondence Schools .....	634	Press Guild, The .....	568	Walnat Electric Mfg. Co....	602
Coto-Coil Company .....	619	J		Pudlin Engineering Co., Ar- thur .....	634	Welsh Elec. Lamp. Corp. ....	632
Coyne Trade & Engineering Schools .....	641	Jones, Howard B. ....	584	R		Westinghouse Union Battery Company .....	623
Crosley Mfg. Company.....	513	K		Radiall Company .....	635	Weston Electrical Instrument Co. ....	608
Cunningham, Inc., E. T., Inside Front Cover		K Electric Company .....	596	Radio Bargains .....	642, 644	Wholesale Radio Equipment Co. ....	638
Cutler-Hammer Mfg. Co., The 517,	607	Kellogg Switchboard & Supply Co. ....	605	Radio Corporation of America, Back Cover		Willard Storage Battery Com- pany .....	585
Cut Rate Radio Company .....	620			Radio Equipment Company..	656	Wilmington Fibre Specialty Company .....	635
				Radio Furniture Co.....	656	Wireless Mfg. Co., The ....	618
				Radiogem Corporation .....	647	Wireless Shop, The .....	616
				Radio Guild, Inc., The.....	581	WorkRite Mfg. Co., The....	621
						World Battery Company ....	659
						Y	
						Young Mfg. Company.....	586

# "This Free Book Showed Me the Way to Big Money in Radio"

It has Started Thousands on the Road to Independence and Success—has Lifted Them Out of the Rut of Office Routine and Helped Them Become Experts in This Fascinating, Profitable Profession. Let It Do the Same For YOU.

SIX months ago I was what you might call "a handy man about the office." I had what I considered a good job with a large manufacturing concern. Having taken a two year's business course, I knew enough of stenography and elementary bookkeeping to be of real value in general office work.

I took special dictation from the President, assigned general correspondence to the regular typists, was responsible for the purchase of office supplies, approved petty cash vouchers for the errand boys and clerks, and was entrusted with the responsibility of making deposits at the bank and bringing in the payroll.

In addition to these, I was often privileged to arrange accommodations for the President when he went off on a trip. And when he wanted some personal matter attended to, such as purchasing theatre tickets or having his evening clothes brought down to the office, I was always selected for such tasks. I was, in fact, an assistant to the President. And accordingly I was paid \$40 a week.

I won't say that I was satisfied with this salary—although it was more than the other clerks were getting—but the fact that the President had confidence in me gave me a certain standing among the others which kept me fairly contented.

Then one day, having a little extra money on hand, I bought a small radio receiving

set. Several of my chums had radio outfits and I had always wanted one in order to enjoy the broadcast programs in the evenings at home. There was ordinarily nothing unusual about this, yet that little radio set changed my whole slant on life and opened up my future overnight.

I didn't know a thing about radio, but I soon got onto the tricks of operating a receiving set and rapidly became a real "fan." But much to my surprise, I got more fun out of the mechanical operation of my set than I did from the music, speeches, reports and regular programs of the nearby stations.

Then I began to take my set apart, reassemble it and experiment. I rigged up an outdoor aerial and installed a tube set. Then I bought a loud speaker and gradually added part by part until I had a first class outfit with a wave-length capable of "picking up" the programs from distant stations.

Naturally, I didn't stop there. Several of my friends had "sending" sets and I wanted nothing less. I began to study the code and longed for the day when I could get a license and have a "call letter" of my own. My routine, humdrum work at the office began to lose its appeal. I could hardly wait until evening came so that I could get home to the "work" I actually enjoyed.

One day the traffic manager at the office mentioned that he was going to buy a radio and flattered me by asking my advice. I offered to help him select a set and install it. He told me to go ahead, rig one up for him and let him know what I wanted for my trouble. It wasn't trouble—it was *real fun*—and I made \$30 for a single night's amusement.

That set me thinking. Why not get into radio in earnest? Two fellows I knew had given up office work and were making big money as Certified Radio-tricians. One was a salesman for a large radio manufacturer, with a fine office of his own in his home town; the other was a ship operator, traveling around the world, seeing the things I had always wanted to see—and getting *big money* for doing it.

I decided to study radio and train for a real job. But I wasn't in a position to give up my work at the office, for I had saved little or nothing, and had to contribute something at home every week.

Then one day I noticed an advertisement in *Radio News*. The heading first attracted me for it read—"Men Wanted in Radio—You Can Train at Home for One of These Big-Paying Positions—This Free Book Will Tell You How." Here was a chance, I



thought. At least it wouldn't cost anything to get the book for it was *free*.

I sent for the book—"Your Opportunities in Radio." That was six months ago. What this free book meant to me is best explained by the fact that, as a Certified Radio-trician, my income this year will be at least \$5,000. And that's only the beginning. For I can already see the enormous possibilities for trained men in this fascinating, profitable profession. And I'm going to get my share of the big money being made by those who are "growing up" with this fast growing industry.

Thanks to the splendid training which I got from the National Radio Institute, *in my spare hours at home*, and with a Government First Class License in my pocket, the rest is up to me. But the opportunities for money, independence and success are unlimited in radio and I'm going to go the limit.

I won't attempt to tell you all the details of the wonderful opportunity that awaits you in radio. The Free Book of the National Radio Institute—the same one that I sent for—will tell you all you want to know. It showed me the way to *big money in radio*—it lifted me out of the rut of office routine and made me an expert in this fascinating profession. Why can't it do the same for you? It *can*—the 40 page, fully illustrated *free* book will tell you how. The coupon will bring it to you—without obligation. Why not send for it—TODAY

## NATIONAL RADIO INSTITUTE

Dept. 13L WASHINGTON, D. C.

NATIONAL RADIO INSTITUTE,  
Dept. 13L, Washington, D. C.

Without obligation on my part, please send me the free book, "Your Opportunity in Radio", with full details as to how I can quickly train for the position of "Certified Radio-trician" in my spare hours at home. Also tell me how your free Employment Service will help me secure a good paying position.

Name .....  
Street .....  
City ..... State .....

### PICK OUT THE JOB YOU WANT WE WILL HELP YOU GET IT

This is a brief list of the positions in the Radio field today, and the salaries paid—

Radio Mechanic, \$1,500 to \$4,000 a year.

Radio Inspector, \$1,800 to \$4,500 a year.

Radio Salesmen, \$2,000 to \$10,000 a year.

Radio Engineer, \$3,500 a year and up.

Radio Executives up to \$15,000 a year.

Radio Instructor \$200 to \$500 a month.

Radio Draftsmen, \$7 to \$15 a day.

First Class Ship Operator, \$105 a month, all expenses paid.

Second Class Ship Operator, \$95 a month, all expenses paid.

Third Class Operator, \$85 a month all expenses paid.

Commercial Land Station Operator, \$150 a month and up.

Broadcasting Station Operator, \$125 to \$250 a month.

### NOTE: RADIO FIRMS

Secure Practical Radio Experts Among Our Graduates. Write today.

The Royalty  of Radio

# New Additions to

## Beautiful New Furniture Models— Simplified Tuning—Self-contained

The three new Kennedy Furniture Models illustrated on this page are the very last word in radio receiving sets. Even if attention were drawn no further than their exterior beauty, their purity and harmony of design alone would be instantly appreciated.

The receiver in each is a new achievement of the Kennedy Engineering Staff. Extreme simplicity of tuning is attained with the same selectivity and long-distance reception that have made Kennedy sets so well and favorably known. Only two dials are used—one for "tuning in" or selecting the desired station, the other to control sound volume. Adjustment is provided for very fine tuning.

These models are complete and self-contained. They operate on dry battery tubes for which internal space is provided, although any standard tubes—including storage battery type—may be used. Two stages of audio amplification—built-in loud speaker with unusually clear and distortionless qualities of reproduction. Highly polished Formica control panels. Gold-plated metal trimmings on front—including dials. Respond to all broadcasting wave-lengths. Each complete with three dry-battery tubes, all dry batteries and Kennedy 3000-ohm phones with plug, for individual reception.

**Kennedy Model X.** Beautiful hand rubbed Mahogany cabinet with inlay of Satin Wood and Ebony. The tracery, in delicate contrast with background, is suggestive of the marquetry workers of King William's time. Price, complete.....\$285.00

**Kennedy Jacobean Console Model.** Exemplifies the late Jacobean design. Built of American Walnut with artistically matched paneling, which contributes the rich subdued effect almost always associated with true elegance. Price, complete.....\$775.00

**Kennedy Spanish Desk Model.** An adaptation of the Spanish with a free intermingling of the effects of the Moorish influence. This is particularly in evidence in the panel. Cabinet finished either in Mahogany or American Walnut. Interior lined completely with Golden Bird's-eye Maple. Price, complete....\$825.00

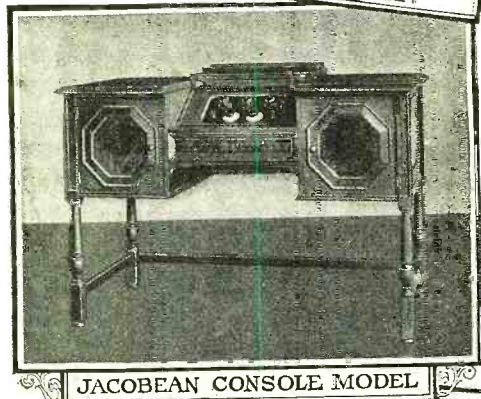
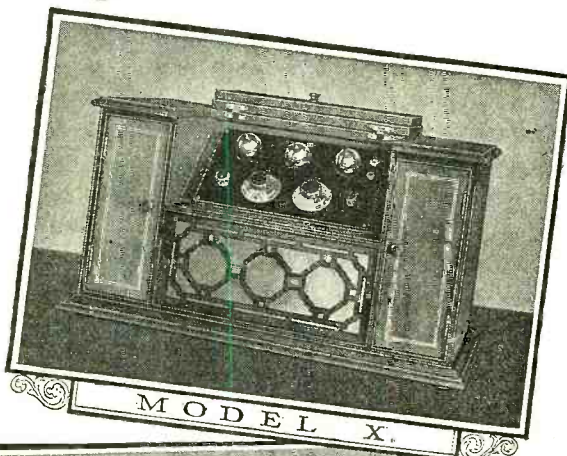

# KENNEDY



The Royalty of Radio



# the Kennedy Line

## A New Popular-Priced Model, Head Phones and Loud Speaker

The apparatus shown on this page is of the same high character as the more elaborate Furniture Models. The sets were designed to fill the demand for high quality at a popular price, and, with the wonderfully improved head phones and separate loud speaker unit, they provide Kennedy apparatus for every home.

**Kennedy Model V.** Incorporates the new Kennedy receiver and two-stage amplifier at moderate cost. Same type of radio unit as higher priced Furniture Models, but without loud speaker. Highly polished Formica control panel. German silver dials. Space for batteries. All dry batteries, three dry-battery tubes and Kennedy phones with plug, complete...\$125.00  
Receiver only, without phones, tubes or batteries....\$ 86.50

**Kennedy Type-281.** One of the sets that has won recognition for the Kennedy line. An extremely selective three-circuit receiver. Solid Mahogany cabinet. Brilliantly polished Formica control panel, black etched dials, heavily nickel-plated metal parts. Wave-length range 175 to 900 meters. Designed for 6-volt tubes but can be used with dry-battery tubes as well. Receiver only.....\$ 90.00  
Receiver and two-stage audio amplifier.....\$145.00

**Kennedy Type-311, 522 Portable.** Neat, compact, portable. Easily tuned—highly selective and efficient. Designed for all standard tubes, including dry-battery type. Detector and two stages of audio amplification. Wave-length range 150 to 600 meters. Complete with three dry-battery tubes, all dry batteries and Kennedy phones, with plug.....\$137.50

**Kennedy Loud Speaker.** The same as used in the new Kennedy Furniture Models. Remarkable fidelity of reproduction, with total absence of unpleasant distortion. No separate batteries required. Price, complete with 6 ft. cord..\$30.00

**Kennedy Head Phones.** Perfection in mechanical and electrical design results in unusual volume with rich tonal purity. No rattle or blare. Extremely sensitive on weak and distant signals. Light and snug fitting. Resistance 3000 ohms. Price per set, with 6 ft. cord.....\$9.00

See the new sets and parts at the nearest Kennedy dealer or write us direct for literature. State type of set in which you are interested.

**DEALERS** Write or wire for exclusive Kennedy proposition.

THE COLIN B. KENNEDY COMPANY

SAINT LOUIS

SAN FRANCISCO

All Kennedy receiving sets are regenerative—Licensed under Armstrong U. S. Patent No. 1,113,149.

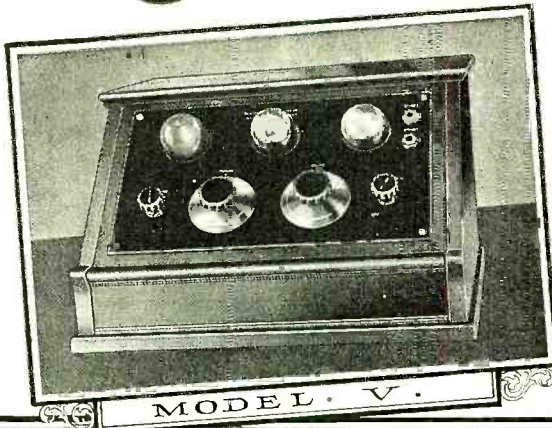

MODEL V.

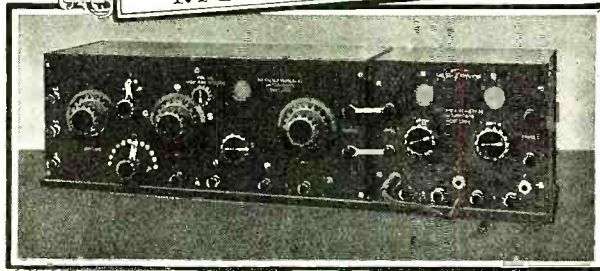

TYPE 281.



PORTABLE COMBINATION SET

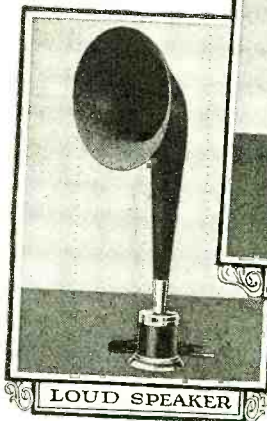

LOUD SPEAKER

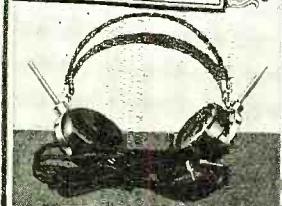

PHONES

7

# KENNEDY

# THE NEW ACE

## Three Tube Regenerative Receiver

Manufactured under Armstrong U. S. Patent  
No. 1,113,149

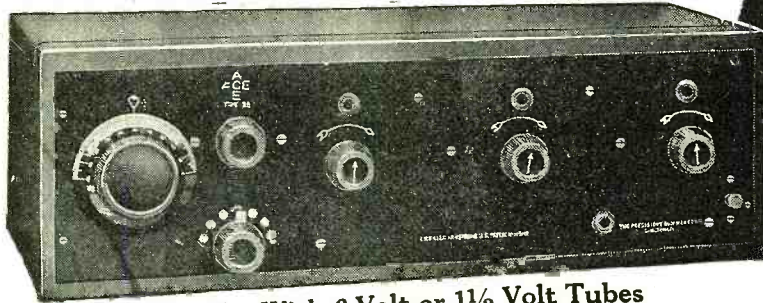

For Use With 6 Volt or 1 1/2 Volt Tubes

# 3B

ONLY

# \$50.00

This New  
Ace Type 3B  
Armstrong Regen-  
erative Radio Receiver combines  
detector and two stages of Audio frequency  
amplification. The lowest priced quality  
receiver ever offered. When you tune in  
with this set distant stations come in as  
though they were only a few miles off.  
The two stages make the use of a loud  
speaker possible—this is a desirable feature.  
Its efficiency has passed every test.

One of the few sets that functions perfectly  
with all makes of tubes. A filament switch  
eliminates necessity of turning out the rheo-  
stats when set is not in use. With this switch  
you can turn off set and come back later to  
same concert without retuning. The tele-  
phone jack makes it possible to use head  
phones. When head phone plug is inserted  
it automatically eliminates loud speaker, but  
does not affect the filament current. Has  
genuine mahogany cabinet with beautifully  
engraved panel.

If your dealer cannot supply you, order  
direct, mentioning his name. Ask for  
"Simplicity of Radio" your copy is FREE.

DEALERS: write on your letterhead for  
attractive sales proposition.

**THE PRECISION EQUIPMENT COMPANY**

*Russell Crowley Jr.* PRES.

1122 Vandalia Ave.,

Cincinnati, Ohio



## THE ACE TYPE V

Armstrong Regenerative Receiver  
Manufactured under Armstrong U.S. Pat. No. 1,113,149

The low cost of this set together with its  
efficiency and simplicity makes the great  
demand for it increase daily.

A long range receiver. Stations from  
coast to coast can be heard dis-  
tinctly. An Ace Two-step Amplifier  
in connection with this set at \$20  
makes use of loud speaker practi-  
cal. Has Crosley Multistat, which  
permits use of any make tube.

# \$20



## Abroad at Home with a CROSLEY MODEL X-J

PRICE \$65

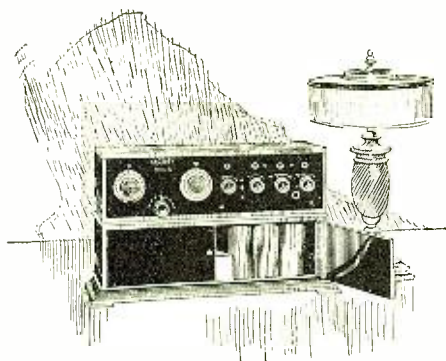

### CROSLEY MODEL XJ

A 4 tube radio frequency set, incorporating one stage of Tuned Radio Frequency Amplification, Detector and two stages of Audio Frequency Amplification, with jack to plug in on three tubes for head phones; new Crosley multistats, universal rheostats for all makes of tubes; new condenser with molded plates; filament switch and other refinements of details. A mahogany battery cabinet which makes the set completely self containing may also be had to fit the Model XJ at a cost of only \$16. See illustration above.

See this beautiful receiver at your dealers.

Wonderful opera from New York, love songs from the tropics, dance music from Chicago; stock quotations, stirring speeches, amusing stories from where you will—all these pleasures and utilities are brought truly, clearly, right to your fireside if you own a Crosley Model XJ Radio Receiver.

This beautiful new Crosley 4 tube Model contains the same units as the famous Crosley Model X, with added refinements of detail which make it even better. At bringing in distant stations, the Model X established many records during the past year. Sebring, Fla., continually heard Honolulu. A man writes from Nassau, British West Indies, "First of all on Friday night, June 29, 1923, I heard Honolulu." He goes on to relate that practically all stations in the United States were brought in clear as a bell.

With the Crosley Model X-J even better receptions are assured. We unhesitatingly claim that it is the best radio receiver ever offered, regardless of price.

### For Sale By Good Dealers Everywhere

Write for free catalog which shows the complete Crosley line of instruments and parts. In it you will find just the receiver to suit your needs, and pocketbook. Crosley Receivers without batteries, tubes and head phones range in price from the efficient 2 tube Model VI at \$28 to the beautiful Console Model at \$150.

Crosley Manufacturing Co.  
1122 Alfred St. Cincinnati, Ohio

**CROSLEY**  
Better - Cost Less  
Radio Products

New York Office, C. B. Cooper, 1803 Tribune Building,  
154 Nassau Street, Beekman 2061.

Boston Office, B. H. Smith, 755 Boylston Street, Room 316.

Chicago Office, 1311 Steger Building, 28 E. Jackson Blvd.,  
R. A. Stemm, Mgr.

Philadelphia Office, J. H. Lyte, 65 North 63rd Street.

St. Louis Office, Robert W. Bennett Co., 1326 Syndicate  
Trust Building.



# WITH BARAWIK STANDARD RADIO GOODS

**VACUUM TUBES**  
Standard Brands—Cunningham, Radiotron. Every one guaranteed new and perfect. We will ship brand in stock unless you specify otherwise.

D105 Detector, UV200 C300 Each \$4.30  
D112 Amplifier, UV201A C201A 5.75  
D118 5 Watt Transmitter 7.70  
D107 WD11 C11, Each 5.75  
D101 WD12 C12, Each 5.75  
D104 UV199 Adapter fits 199 tube to standard socket .42  
D108 WD11 Socket, Each .35  
D109 WD11 Adapter, Each .48

**STANDARD TUBE SOCKET**  
D140 Each .39c  
Moulded of genuine red brown bakelite. Blinding post connections. For table or panel mounting. Neat and strong.

**METAL TUBE SOCKET**  
D146 Each .42c  
A strong durable socket for panel or table mounting. Metal tube and base. Plainly marked binding post connections well insulated.

**TWO AND THREE GANG SOCKETS**  
These sockets make it easy to build detector and amplifier units and make a neat, compact workmanlike job. Perfectly made of high grade materials. Quickly mounted on panel or base.

D147 Two-gang socket .95c  
D149 Three-gang socket 1.30

**199 SOCKET**  
D145 Each .49c  
Moulded of high insulating material. Sponge rubber base prevents ringing in tube. Plainly marked binding post connections. Neat and compact.

**FILAMENT CONTROL RHEOSTATS**  
D132 6 ohm. Each .45c  
D129 20 ohm. Each .52c  
D131 30 ohm. Each .59c  
D135 60 ohm. Vernier. .95c  
Best grade. Will give real service. Durable and lasting. High heat resisting base, diam. 2 1/2 in. Tapered polished black knob 1 1/2 in. diam. Potentiometer with above rheostats. Same high grade construction.

D151 200 ohm. Each .79c  
D152 100 ohm. Each .79c

**SUPERIOR RHEOSTATS**  
D153—6 ohm. Each .69c  
D154—20 ohm. Each .76c  
D155—30 ohm. Each .83c  
The finest rheostat. Smooth, even action. Best design, best workmanship. Supplied with attractive dial and knob. A rheostat for high grade sets.

Potentiometers to match above rheostat with dial and knob.  
D156—375 ohm .98c

**QUICK ACTING RHEOSTAT**  
D124—6 ohm. Ea. .79c  
D125—15 ohm. Ea. .88c  
D126—30 ohm. Ea. .99c  
Vernier adjustment at every degree of resistance. Pushing knob in turns off the filament.

**THREE INCH DIAL**  
D923 For 3-16 inch shaft. Each .19c  
D924 For 1/2 inch shaft. Each .19c  
A handsome neat looking dial moulded in one piece of polished black composition. 180° scale marked 0 to 100 finely engraved in contrasting white enamel. Diameter 3 inches.

**TWO INCH DIAL**  
D921 For 3-16 inch shaft. Each .16c  
D922 For 1/2 inch shaft. Each .16c  
A handsome dial moulded in one piece of polished black composition. 270° scale marked 0 to 100 finely engraved in contrasting white enamel. Fine for rheostat or switch control. Diam. 2 in.

**VERNIER DIAL ADJUSTER**  
D941 Each .19c  
Easily installed at edge of dial, gives finest vernier adjustment of condenser or inductance. A great value. Polished black knob.

**DETECTOR CRYSTAL CAREFULLY TESTED**  
D736 Galena, Arlington tested, piece 19c  
D738 Silicon, Arlington tested, piece 19c  
D735 Tested, Galena, Mounted, piece 9c  
D737 Tested, Silicon, net piece .8c  
D739 Genuine million point crystal. Ea. 29c

**GOLD GRAIN DETECTOR**  
D741 Each .79c  
Positive instant operation. No elusive sensitive spot. A slight turn gives you a new adjustment. Especially effective on reflex circuits. Panel mounting brackets included.

**WE PAY TRANSPORTATION CHARGES EAST OF THE ROCKIES**  
PRESERVE THESE PAGES—ORDER FROM THEM AND SAVE MONEY  
FAST SERVICE—TRY US AND BE CONVINCED  
THE PRICES QUOTED DELIVER THE GOODS TO YOUR DOOR

**OUR GUARANTEE PROTECTS YOU**—We handle only the best goods, carefully tested and checked by expert radio engineers. You are assured of getting guaranteed apparatus that will give superior results. And when our goods are best, our prices are lowest. Our goods equal or surpass the claims we make for them. We do not attempt to deceive or mislead. Our reputation for fair dealing is our most valued asset.

**HOW TO ORDER**—Write Your Order plainly, state Article Number, Description and Price of items wanted. Send Postoffice or Express Money Order, Certified Check or Bank Draft for Total of Order. Prompt Shipment is assured when these directions are followed.

**GREWOL CRYSTAL DETECTOR**  
D742 Each \$1.69

**BAKELITE DIALS**  
D931—2 in. Diam for 3-16 in. shaft. Each 32c  
D932—2 in. Diam for 1/2 in. shaft. Each .33c  
D933—3 in. Diam for 3-16 in. shaft. Each .33c  
D934—3 in. Diam for 1/2 in. shaft. Each .33c  
D935—4 in. Diam. for 1/2 in. shaft. Ea. 40c  
Moulded in one piece of genuine bakelite in polished black finish. Finely engraved scale in contrasting white enamel. Sure grip knob that fits the fingers. Higher grade dials for loud sets. Sizes match perfectly.

**ENCLOSED DETECTOR**  
One of the finest crystal detectors on the market, ultra-sensitive galena crystal enclosed in heavy glass shield. Quick, positive adjustment. Brass parts polished nickel finish.

D730 Each .89c

**GALENA DETECTOR**  
Easy fine adjustment. Crystal mounted in cup. Moulded base and knob. Brass parts polished nickel finish. An unequaled value.

D732 Each .59c

**SUPERIOR VARIABLE GRID RESISTANCE**  
D167 Each .80c  
D168 With .00025 condenser .95c  
Eliminates hissing, clarifies signals. Capacity smoothly varied from 0 to 6 megohms by half turn of knob. Easily mounted on any panel.

D171 Freshman panel mounting variable grid leak with .00025 condenser. Each 69c  
D172 Puritan variable grid leak with mounting. Each .89c  
D173 Ctrl. Variable grid leak. Each \$1.19

**TUBULAR GRID LEAKS AND CONDENSERS**  
Very convenient. Permit of quick change of leaks or condensers of varying capacity. Cut leaks leak mounted. Leaks and condensers have same appearance. Each part priced separately.

D819 Grid Leaks. Each .18c  
Resistances—1/2, 1, 1 1/2, 2, 3, 5, 7, and 10 megohms. Specify which size is wanted.  
D831 Grid and Plate Condensers. Ea. 39c  
Capacities—.00025, .0001, .00025, .005 mfd. Specify which size is wanted.  
Mountings. Bakelite base.  
D840 Single mounting. Each .29c  
D842 Double mounting. Each .49c  
D844 Triple mounting. Each .69c

**VARIABLE GRID LEAKS**  
D160 Standard style .15c  
D161 De Luxe style with extra heavy screw top finely finished .32c  
Pencil mark type for panel mounting. Resistance may be varied exactly as needed.

**GRID CONDENSERS**  
D162 Well insulated. Paper covering. Each .8c  
D163 Highest grade. Mica insulated. Polished nickel case. Each .23c  
Fit over posts of above leaks. The combination makes an efficient unit. Tap. .00025 mfd.

**BARAWIK QUALITY HEADSETS**  
D770 Per Set. 2000 ohms \$3.25  
These headsets have proven on rigid tests to be one of the very best on the market. The tone quality is excellent with an unusual volume. Skilled workmen make them from only the best selected materials. The receiver cases are fine polished finish with polished black ear pieces. Fabric covered head band comfortably and quickly fitted to the head. Supplied with 5-foot cord. These sets were designed to sell for much higher prices than we ask, and at our price are a wonderful bargain. We guarantee that you will be pleased with them and agree that they are the best value by far yet offered. If they don't suit you we will cheerfully return your money.

**STANDARD BRAND HEADSETS**  
D754 Baldwin Type C with universal jack plug \$11.75  
D755 Red-Head, 3000 ohm 5.78  
D768 Brandes, 2000 ohm 5.35  
D769 Brandes, 3000 ohm 6.95  
D751 Murdock 56, 2000 ohm \$3.59  
D752 Murdock 56, 3000 ohm 3.95  
D764 Frost, 2000 ohm 3.59  
D766 Frost, 3000 ohm 4.45  
D758 Western Electric 9.50

**BINDING POSTS**  
Brass, polished nickel finish. Washer and 6-32 in. screw extending 3/4 in.

D370 Large size—barrel and knob 3/4" long. Dozen 85c  
D372 Smaller size—barrel and knob 9-16" long. Dozen 70c  
D370-2-4 barrel and knob 3/4" long. Dozen 45c  
D376 Large size with hole for phone tip or wire. Dozen 80c  
D378 Small size with hole for phone tip or wire. Dozen 35c

**PLATE CIRCUIT "B" BATTERIES**  
You can make real savings on these batteries. Don't pay more. We guarantee them to equal any on the market regardless of price. Absolutely uniform. Extra long life.

D180 Signal Corps type, small size. 15 cells, 2 1/2 volts. Each \$1.10  
D182 Large size, 5 taps 1 1/2, 1 3/4, 2, 2 1/2 and 2 3/4 volts. Each \$1.59  
D184 Variable Large Navy size. 1 1/2x4x3 inches. 5 taps, giving range from 1 1/2 to 2 1/2 volts in 1/2 volt steps. Each \$1.95  
D188 Combination Tapped 45 volts, 30 cell, 13x13 battery. Tapped to give 45, 2 1/2, 2 1/2, 1 1/2, 1 1/2 and 1 1/2 volts. Handles both detector and amplifier tubes. Ea. \$3.65

**STORAGE "A" BATTERY**  
A very high grade battery made especially for radio service. Guaranteed for three years. Properly cared for will give many more years of service for filament lighting. Made of best new materials. Full capacity. The best battery buy on the market. Try one of these batteries on your set for 10 days. If at the end of that time you are not fully satisfied with the battery return it and we will refund the purchase price.

D194 6 volt, 30 ampere size. Each \$10.75  
D196 6 volt, 80 ampere size. Each \$13.25

**HOMECARGER BATTERY CHARGE RECTIFIER**  
Charge your battery at home over night for a few cents. Simply connect to any 110 volt 60 cycle light socket, turn on current and rectifier does the rest automatically. Will work for years without attention. Simple connections. Gives a tapering charge which batteries should have. You can make it pay a profit charging your own or friends' auto batteries. Long connecting cords with pair of battery clips.

D201 For 6 volt battery \$12.95  
D203 For 12 volt battery 12.95

**RADIO "BAKELITE" PANELS**  
Notice our very low prices on this fine quality material. Others ask as much for hard rubber panels which are worth much less. We supply genuine Bakelite, Condensite, Cellon or Formica, all of which are materials with practically identical mechanical, chemical and electrical properties. Machines well without chipping. Won't warp. Waterproof. Highest mechanical and dielectric strength. Attractive natural polished black finish which can be sanded and oiled.

Panel Size Inches	1/2" thick		3/16" thick		1/4" thick	
	Art. No.	Price	Art. No.	Price	Art. No.	Price
6x7	D450	\$0.57	D460	\$0.85	D470	\$1.15
6x10 1/2	D451	.86	D461	1.27	D471	1.73
7x14	D458	1.38	D468	2.07	D478	2.76
7x18	D453	1.78	D463	2.65	D473	3.56
7x21	D457	2.05	D467	3.05	D477	5.10
7x24	D459	2.42	D469	3.56		
9x14	D454	1.85	D464	2.65	D474	3.56
12x11	D455	2.42	D465	3.56	D475	4.78
12x21	D456	3.62	D466	5.35	D476	7.13

**CABINETS**  
Fine looking cabinets solidly built. Elegant dark mahogany finish. You will be proud of your set mounted in one of these cabinets. Hinged tops. Front rabbeted to take panels. Panels not included. Prices are transportation paid.

Panel Size	Inside Dimensions			Art. No.	Price Each
	High	Wide	Deep		
6x7	5 1/2"	11 1/2"	7"	D420	\$2.15
6x10 1/2	9 1/2"	10"	7"	D422	2.65
7x14	11 1/2"	13 1/2"	7"	D423	3.20
7x18	13 1/2"	17 1/2"	7"	D426	3.45
7x21	15 1/2"	20 1/2"	7"	D425	3.85
7x24	17 1/2"	23 1/2"	7"	D429	4.65
9x14	8 1/2"	17 1/2"	10"	D428	3.55
12x11	11 1/2"	13 1/2"	10"	D430	4.65
12x21	11 1/2"	20 1/2"	10"	D432	5.45

## THE BARAWIK CO. 102 South Canal St., Chicago, Ill.

BUILD YOUR SET WITH BARAWIK STANDARD RADIO GOODS

JUST OFF THE PRESS

12th Edition

# WIRELESS COURSE IN 20 LESSONS

By S. GERNSBACK, A. LESCARBOURA and H. W. SECOR

Very Greatly Enlarged

Price

**\$2.00**

Postpaid

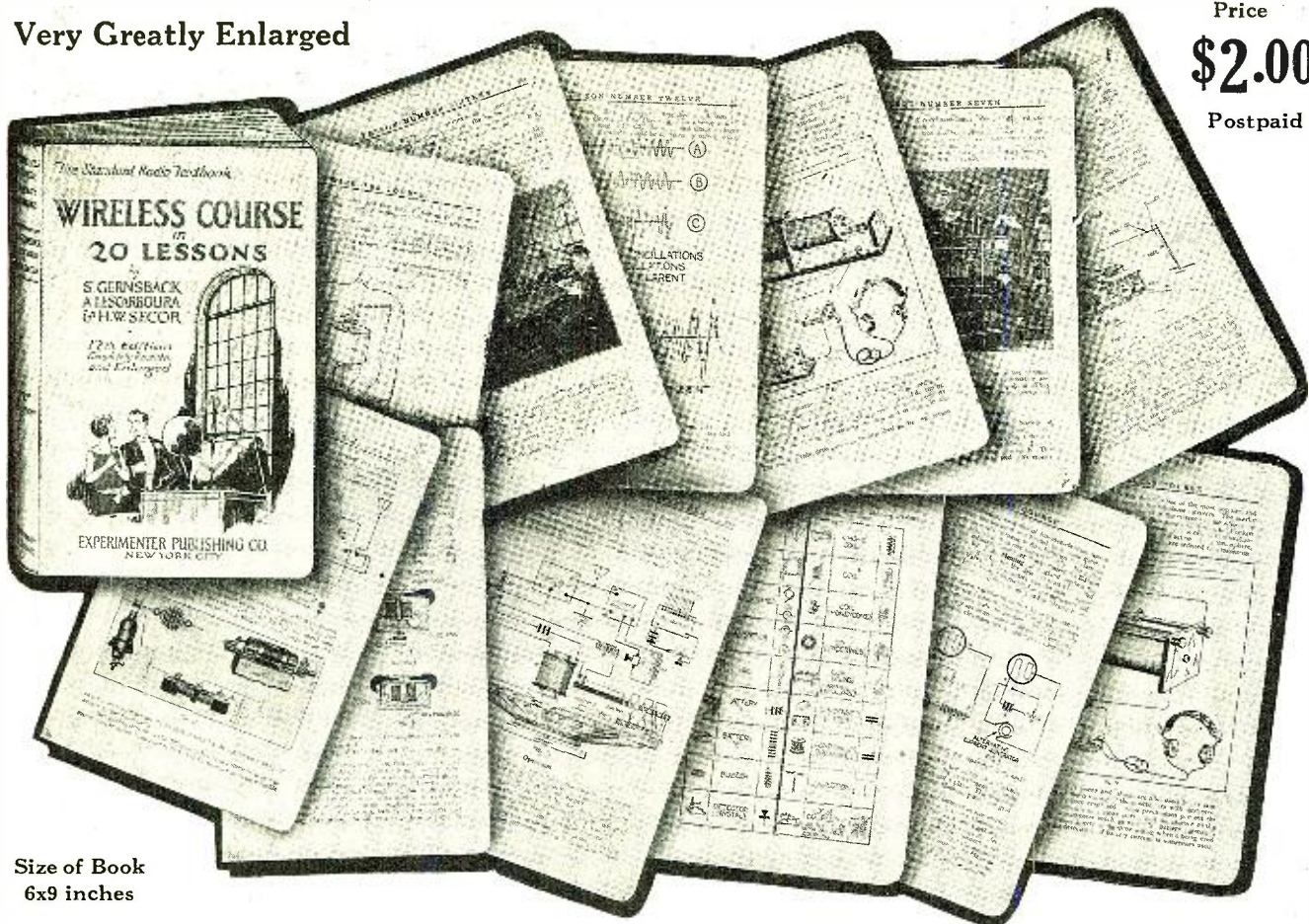

Size of Book  
6x9 inches

264 pages. 500 illustrations, diagrams and photographs. Binding de luxe; black leatherette cover, genuine gold stamped; red edges; round corners; semi-flexible covers; multi-colored jacket.

This new edition contains over 100 pages more than the previous editions, of which over 100,000 were sold. It is printed in a larger type, on better paper and has better and more illustrations.

- Lesson No. 1: Principles of Electricity: History and Explanation of Electricity, etc.
- Lesson No. 2: Principles of Magnetism: The History and Explanation of Magnetism, etc.
- Lesson No. 3: Dynamos, Motors, Generators, and Wiring: Explanation of Construction and Operation of each of the above, etc.
- Lesson No. 4: Principles of Wireless Telegraphy: History and Explanation of the Wave Transmission and those concerned in the development of early radio, etc.
- Lesson No. 5: Amateur Transmitting Sets and Apparatus: Apparatus and Circuits used by Amateurs in the early days of radio telegraphy, etc.
- Lesson No. 6: Transmitting Sets (Continued): Apparatus and Circuits of Transmitting Apparatus, etc.
- Lesson No. 7: Commercial Transmitting Systems: Apparatus and their operation, etc.
- Lesson No. 8: Aerials and Underwriters Installing Regulations: Explanation of the Antenna System and Constructional details of the various types used. Official regulations, etc.

- Lesson No. 9: Radio Receiving Apparatus: Description of the Various Types of Receiving Apparatus with an explanation of their operation, etc.
- Lesson No. 10: The Detector: An explanation of the various types of detectors used for reception purposes, including circuits, etc.
- Lesson No. 11: The Vacuum Tube as a Detector: Principles of operation of the vacuum tubes, etc.
- Lesson No. 12: Regenerative Receiving Set: Description and explanation of various vacuum tube circuits, etc.
- Lesson No. 13: The Vacuum Tube as an Amplifier: Operation of the types of amplifiers as in conjunction with tuners. Loud Speakers, etc.
- Lesson No. 14: Practical Vacuum Tube Circuits: An explanation of various up-to-date Circuits used in Radio, etc.
- Lesson No. 15: Super-Regenerative Receiver: Operation of the Super-Regenerative Receiver, etc.
- Lesson No. 16: Vacuum Tube Transmitter: Vacuum Tube Transmission and Broadcasting Systems, etc.
- Lesson No. 17: Radio Compass—The Wavemeter—Radio Control: The Radio Compass. Principles and operation of the Wavemeter and Radio Control, etc.
- Lesson No. 18: Learning to Operate—The Codes—The Wireless Law: Methods of learning the International Code. Appendix: Detailed regulations of the wireless law, etc.
- Lesson No. 19: History of the Development of Radio: A progressive history of radio and those concerned in its progress, etc.
- Lesson No. 20: Mathematics of Wireless Telegraphy and Appendix: Formulas for the Calculation of Wave-length, Inductance, Capacity, and other measurements, etc.

Sent postpaid upon receipt of \$2.00

If your Dealer cannot supply you, order direct from us, giving Dealer's name and address

**Experimenter Publishing Co., 53 Park Place, New York, N.Y.**

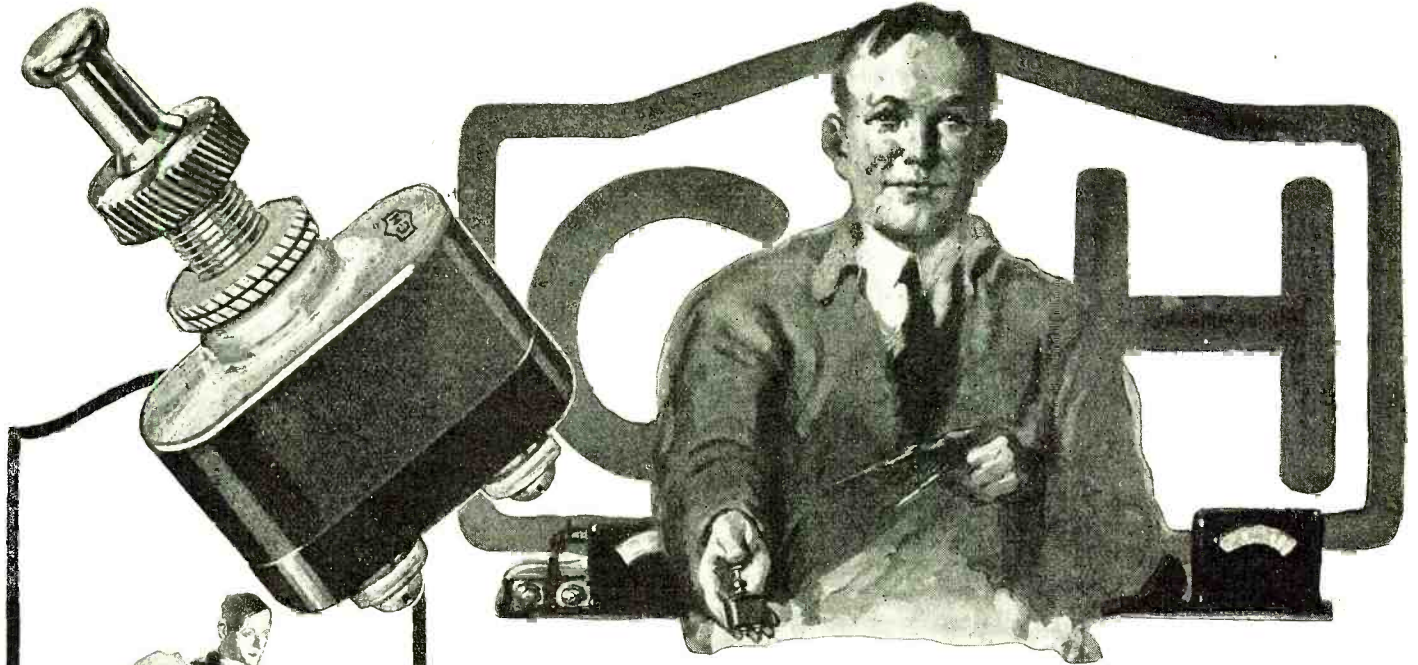

## A Switch by the Master Builder for Your Radio Panel

*Beautiful Appearance  
Correctly Designed—Easily Installed*

In the radio world the name Cutler-Hammer and its symbol the famous C-H trade-mark have become guide posts to quality. In only a few months after their introduction more than a half million radio rheostats with the little mark of approval of the master builders of all electrical control apparatus were purchased.

Now these specialists offer another necessity for your panel, the C-H Radio Switch embodying the same careful design and workmanship to provide more pleasant, convenient reception and protect your expensive equipment at a negligible cost. Its sturdy knife blade mechanism that snaps—not merely slides—is capable of carrying 3 amperes at 110 volts, yet is built with a precision that enables you to use it in your most delicate circuits without any microphonic noises.

It will control your "A" battery to positively indicate whether the tubes are *on* or *off*—your "B" batteries—parts of circuits—condensers—battery charger—practically any demand you may have for current control. It is fully adjustable for panel thickness and can be installed in any set in a few minutes—only a single  $\frac{7}{16}$ " hole is required. Carried by dealers everywhere—if yours has not yet been stocked, send 75c plus 10c carrying charges and you will be supplied direct

**THE CUTLER-HAMMER MFG. CO.**

*Member Radio Section, Associated Manufacturers of Electrical Supplies  
MILWAUKEE · WISCONSIN*



Disconnecting a battery lead is one way of shutting off a radio set, but many tubes and batteries have been ruined by putting it back on the wrong post. A C-H Radio Switch costs 75c—if you save only a few dry cells it quickly earns its cost.

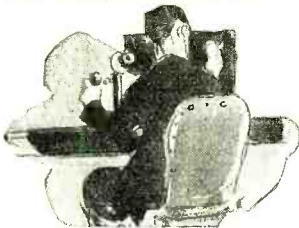

What do you do when the phone rings? Just push the C-H Radio Switch button—answer the phone—pull the button and the same program is back on. No turning back rheostats or disturbing your delicate settings when you have C-H convenience.

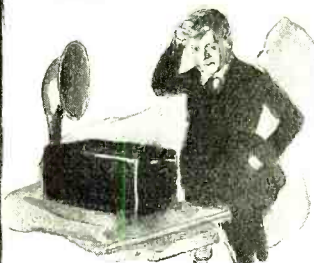

With the new tubes that operate at a dull red it is easy to forget to turn off the "A" battery—there is nothing to indicate whether the set is ON or OFF. The nickel button of a C-H Radio Switch sticks right out to say "I'm ON—don't forget me!"



# RADIO SWITCH

# FROST-RADIO

*Ask Your Neighbor*

## FROST-FONES



A new **FROST-FONE** with drawn aluminum shells.  
No. 161, 2000 ohms.\$4.00  
No. 171, 3000 ohms.\$5.00

**T**HERE is now a **FROST-FONE** to fit the purse and requirements of every radio user. For those who wish the economies of the metal shell type, we have developed to a high degree of perfection our Nos. 161 and 171 Aluminum Shell **FROST-FONES** with special head band. Highly polished drawn aluminum shells, composition caps. Supplied in 2000 and 3000 ohms.

For those who prefer the superior qualities of the famous No. 162 **FROST-FONE** we have good news: These popular fones have been improved with reinforced V cord and lead wires, sturdy terminal block and covered magnets. Still the world's greatest value.

Our No. 172 Genuine Maroon Bakelite fones, highly polished, in 3200 ohms, embody new principles of construction, eliminating "lead" wires. Made with moulded-in terminal blocks.



No. 172, a new **FROST-FONE** with Maroon Bakelite Shells and Caps, 3200 ohms.....\$6.00  
No. 162, 2000 ohms (composition shells and caps), ..... \$5.00

## FROST-RADIO

A glance at this page will suffice to show that the line of **FROST-RADIO** items has been greatly increased with the addition of many new items. On this page we show the wonderfully popular **FROST-RADIO** Tube-Control Unit, Rheostats, both plain and vernier and Potentiometers. With the exception of our Nos. 600-601 Type, these all are made with maroon bakelite frames, fluted and polished black bakelite knobs, and nickel plated buffed levers, binding posts and pointers. All are arranged for single-hole mounting in a rigid, patented construction exclusively our own. Our No. 607 Tube Control Unit, comprising rheostat, vernier, and potentiometer, is destined to be tremendously popular, as there is nothing exactly like it on the market.

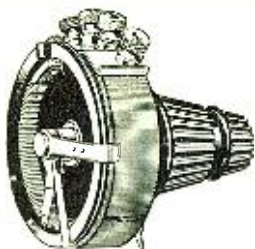

**FROST-RADIO**  
No. 607, Maroon Bakelite Tube Control Unit, \$1.75

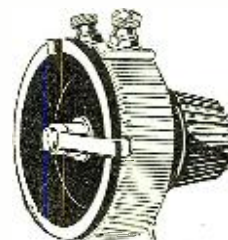

**FROST-RADIO**  
No. 650, Maroon Bakelite Rheostat, 6 ohms ..\$1.00  
No. 652, 35 ohms...\$1.00

## HERBERT H. FROST, Inc.

154 WEST LAKE STREET, CHICAGO, ILLINOIS.  
30 Church St., New York

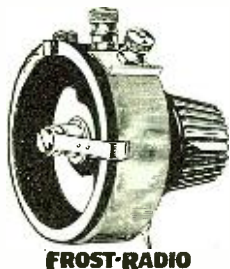

**FROST-RADIO**  
No. 654, Maroon Bakelite Potentiometer, 400 ohms ..... \$1.25  
No. 655, 200-400 ohms ..... \$1.25  
No. 603, 400 ohms, Metal Frame Potentiometer.....60c



**FROST-RADIO**  
No. 600, Metal Frame Rheostat, 6 ohms.....60c  
No. 602, 35 ohms.....60c

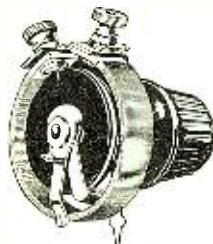

**FROST-RADIO**  
No. 601, Metal Frame Vernier Rhe't, 6 ohms 75c  
No. 603, 35 ohms.....75c  
No. 605, 200-400 ohms.....60c

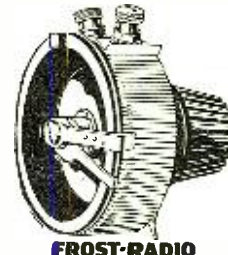

**FROST-RADIO**  
No. 651, Maroon Bakelite Vernier Rheostat, 6 ohms.....\$1.25  
No. 653, 35 ohms...\$1.25



# FROST-RADIO

*Ask Your Neighbor*

These new **FROST-RADIO** items reflect advanced radio design and construction



**FROST-RADIO**

No. 612, Bakelite Socket for C-299 tubes, panel or table mounting.....50c

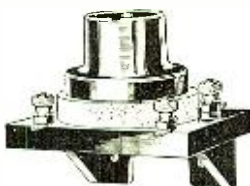

**FROST-RADIO**

No. 617, Bakelite Shock Absorber Socket for C-299 tubes, panel or table mounting .....\$1.00

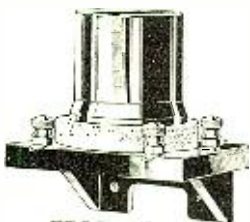

**FROST-RADIO**

No. 618, Bakelite Shock Absorber Socket, Standard base, panel or table mounting .....\$1.00



**FROST-RADIO**

No. 631, Bakelite Inductance Unit for short wave sets. Complete as shown, ..... \$2.50



**FROST-RADIO**

No. 611, Bakelite Adapter for C-299 tubes.....50c



**FROST-RADIO**

No. 620, Bakelite Potentiometer Cut-out switch, .....50c



**FROST-RADIO**

No. 614, Bakelite Spider Dial, 2½ in.....50c  
No. 615, 3 inch.....60c

ON this page we show the complete line of new **FROST-RADIO** genuine bakelite vacuum tube sockets, dials, adapters, inductance units, battery and potentiometer switches. These are made from highest quality moulded bakelite, polished. Advanced design and improved methods of construction make these items best of all for your set.

Note our new shock-absorber sockets, cushioned with finest sponge rubber, and fitted with fusible coiled "lead" wires which remove all direct contact with the base and make these sockets absolutely non-microphonic. Note also that they may be used for either table or panel mounting. Metal parts are nickel plated, polished and hand buffed. Construction throughout the very best—and fully guaranteed by the name of the maker.

Go to your dealer to-day and see these new **FROST-RADIO** items—order your requirements for your new set—note their high quality and fine workmanship. There is a **FROST-RADIO** dealer near your home.

**HERBERT H. FROST, Inc.**  
154 WEST LAKE STREET, CHICAGO, ILLINOIS.  
30 Church St., New York

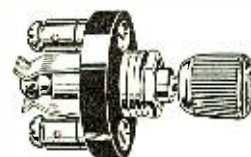

**FROST-RADIO**

No. 608, Push-Pull Battery Switch.....30c

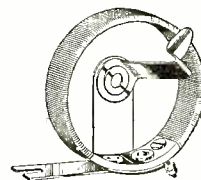

**FROST-RADIO**

No. 630, Resistance Unit for storage battery use, 35 ohms.....25c



**FROST-RADIO**

No. 619, Bakelite Shock Absorber Gang, Standard Base.....\$2.75



**FROST-RADIO**

No. 616, Bakelite Shock Absorber Gang, C-299, ..... \$2.75

# Comparison proves FIL-KO-STAT Supremacy

**A**T FIRST it was just our own word. We claimed Filkostat was best. We proved it by laboratory comparisons.

Now radio fans everywhere are joining in the chorus: "Filkostat is the best filament control." Their own working comparisons prove it and the testimony keeps pouring in. Here is some of it.



Recommended and sold by Dealers in High Class Radio Supplies

Price \$2

In Canada 2.75

"I have tried four different rheostats and must say the Fil-Ko-Stat beats them all." W. R. Hagedorn, Hay Springs, Nebraska.

"The Fil-Ko-Stat is the most satisfactory instrument of its kind I have ever used." Arland M. Kenny, D. M. D., Boston, Mass.

"Since using your Fil-Ko-Stat, I have picked up five stations I never heard before." A. S. Allsup, Kansas City, Mo.

"In my estimation the Fil-Ko-Stat is the finest adjusting rheostat on the market." C. J. Eastman, Radio Engineer, Omaha, Nebraska.

"It is only since using the Fil-Ko-Stat that I realize how wonderful a radio set can be made." S. George Kerngood, New York.

"I have tried all rheostats on the market, and the Fil-Ko-Stat is so far superior for fine tuning, that you are certainly deserving of every radio fan's good wishes." R. C. Stewart, Williamsport, Pa.

"Fil-Ko-Stat results are simply wonderful. Reception of broadcast was a revelation to me, absolutely no noise or distortion of any kind. I have been using a wire rheostat and tube noises, etc., which were impossible to eliminate are entirely done away with." George A. Farley, Baltimore, Md.

"I am of the opinion that the Fil-Ko-Stat is the best filament control on the market. I have recommended the instrument highly and it is a fact that I picked up two Los Angeles stations with a single regenerative detector shortly after installing it." Paul H. Woodruff, Chicago, Ill.

"Comparisons were made with every reliable filament control on the market and we are pleased to note that your Fil-Ko-Stat gives the closest possible adjustment of any type of vacuum tube, and was the only instrument which could be used for all tubes, giving equal critical adjustment at the high resistance as at the low resistance." Radio Guild, Inc., New York.

FIL-KO-STAT, distinctly designed to permit infinite adjustment of the minute electric currents used in heating the vacuum tube filament, gives absolute control of electronic flow and the finest tuning possible, conquering distance and eliminating noise.

FIL-KO-STAT has no screws to tamper with, no adjustments to puzzle you. Only two terminals and you use them for ALL tubes—including 5 watt transmitting tubes. It is triple tested and adjusted at the factory to the ideal "off" position for any of them.

FIL-KO-STAT resistance element is the result of considerable experimentation. It is 70% metallic substance.

While the inability of the wire rheostat to properly control the electronic flow is generally admitted, it is also wise to avoid the use of inferior powdered carbon rheostats. Our experiments have proven them unreliable. Our experiments likewise proved the weakness of the easily broken disk type.

Filkostat reliability and durability are unconditionally guaranteed by the manufacturer.

The D. X. Instrument Co., Harrisburg, Pa.

## RADIO STORES CORPORATION

SOLE INTERNATIONAL DISTRIBUTORS  
DEPT. RN 11-218-222 W. 34th ST., NEW YORK

We have a limited edition of W. G. Merritt Garvey's Radio Hand Book. It contains hook ups, general statistics and advice to the set builder. Discovering that Mr. Garvey recommended the Filkostat for fine filament control, we have taken over an edition and will send a copy of this booklet anywhere at the handling cost of 10c.



Full Resistance

30 ohms



# RADIO NEWS

**H. GERNSBACK—Editor and Publisher**  
**ROBERT E. LACAULT—Associate Editor**

EDITORIAL AND GENERAL OFFICES, 53 PARK PLACE, NEW YORK

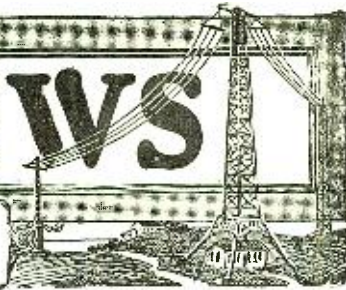

Vol. 5

NOVEMBER, 1923

No. 5

## Amateur Radio

**T**HE word amateur in its relation to wireless—now Radio—was probably used first by the writer in his magazine—MODERN ELECTRICS—the pioneer radio publication—in the April, 1908 issue. At that time there existed practically no radio amateur, as we understand the term today, in America, and for that matter anywhere else in the world. At that time the radio amateur was an experimenter who either sent or received wireless code. In those early days, everyone who dabbled in wireless was an amateur. It mattered not if you had only a coherer set to receive the code with or whether you had a sending and receiving outfit capable of transmitting and receiving messages for one or two miles. Everyone who delved into wireless as a pastime with no intention of deriving profit from his hobby was an amateur.

During the past few years the status of the radio amateur has changed somewhat. No longer is the modern amateur willing to sit in his attic and listen to commercial code messages from ships, land stations, and other commercial stations, which 20 years ago embraced practically all of the radio traffic. The modern amateur has become a world unto himself. He has his 5- or 10-watt well designed and sharply tuned tube transmitter and he sends code to his fellow amateurs, hundreds, and even thousands of miles away, bridging even the Atlantic and the Pacific. He sends and receives *only* private amateur messages and is not at all interested in commercial messages. He is also luke warm towards listening to broadcasting stations and if he is a dyed-in-the-wool, honest-to-goodness amateur, he never publicly admits that he has ever listened to a broadcast concert. This is below his dignity.

The modern amateur sends and relays messages to his friends across the continent and assists wherever possible the authorities for the welfare of the community. In some instances, radio amateurs have been instrumental in apprehending thieves of stolen automobiles; he has helped telegraph companies to handle traffic when the wires were down; and can usually be relied upon to do his share when the country is in danger by war or when a catastrophe occurs. Indeed, if there had been many Japanese amateurs—which we are sorry to say there were not—a good many lives and untold distress could have been avoided, if the non-existing Japanese amateurs could have been pressed into service to transmit intelligence when there was no other way to transmit it.

We are quite confident that if such a national cataclysm had occurred anywhere in the United States, the American amateur would have responded on a grand scale to bring order out of the chaos.

Like radio itself, the radio amateur is also changing and will continue to change to keep up with the tendencies of the times. The last year has turned the radio art completely topsy turvy, and a new order of amateurs is arising in the vastly increased field of radio. We now have a distinct class of new amateurs, which perhaps can be better termed "radio experimenters." This new crop of devotees to the art are not at all interested in code or relay work and do not care about transmission or reception of code. Nor are these people just BCL's (broadcast listeners), but they are serious minded workers. They are known mainly for building myriads of receiving sets and as quickly as a new set is described in literature, the experimenter will usually build it over night. The writer knows of a banker who has no less than 18 sets of the latest types from the Reinartz down to the Neutrodyne, and these outfits are not make-shifts. They are all carefully built. Wiring is done with bus bar wire and the connections are soldered,

and many a manufacturer would be proud to turn out any one of these 18 sets. This man is by no means an exception. He is present in every community, and he knows his business. He is not only an experimenter, but he knows the theory of a vacuum tube and knows all about amplification and has a few hook-ups of his own that have not been published anywhere. To be sure, quite a host of broadcast listeners become regular amateurs who have stations to transmit and receive code and do relay work. But we believe that the new order of radio experimenters of today vastly outnumber the orthodox radio amateur as we know him.

In talking to a number of these new radio experimenters, we have ascertained that they have no interest in code work at all and as a matter of fact do not believe in it. If, however, they could use the radio telephone, they would not be averse towards using it as a means of communicating with friends or acquaintances.

Personally, the writer thinks that the day is coming when the two classes, the radio amateur and the radio experimenter, will be amalgamated into one large class, the extent of which can only be dimly foreseen to-day. Already, if you are awake after eleven o'clock in the evening and tune down to 200 meters, and if you happen to live in a large center, you will hear not only one, but dozens of amateurs conversing with each other by radio telephone. Every radio amateur, who has a tube transmitter can send radio telephone messages as well by the simple addition of a \$2.00 microphone. Indeed the amateurs themselves are waking up to the fact that for short distance work the radio telephone is more satisfactory than code, and while amateurs have been able to send radio telephone messages for over a thousand miles, such distances are considered freak work. Over a radius of 50 miles, however, the radio telephone is becoming very popular with the amateur. This, by the way, the writer foreshadowed in his editorial in the December, 1919 issue of RADIO NEWS. The advantage of the radio telephone, particularly for short distance work, is that radio telephone messages can be transmitted more rapidly than code—at least three or four times as fast.

If the amateur were to resort to loop transmission on wavelengths of 150 meters and upwards, he would do away with quite a good deal of interference because the transmitting wave would then be directive. (An article on loop transmission appears in this issue.) Of course, at the present time, it is not as yet feasible, nor practical, for all amateur traffic to switch over to the radiophone, but sooner or later, this will come about. At the present time, the Department of Commerce insists that every licensed amateur, quite rightly, must pass an examination, and no license is issued unless the amateur is proficient in sending and receiving code. We believe, however, that this ruling, as soon as the radiophone becomes sufficiently popular, will be modified, and the time will come when any radio enthusiast can rig up his sender and call up friends at his pleasure and converse with them. It probably will consume 5 to 10 years to make this transition.

This does not mean that code will go out of use entirely. The invention of the telephone did not displace the telegraph. For certain purposes the amateur will always resort to code where greater accuracy and range are desired, but we believe that in the radio amateur world, the proportion of code to phone traffic in time will be in the proportion of the wire phone messages to the telegraph messages. And as every one knows, there are over 10,000 phone conversations to one telegram.

H. GERNSBACK.

### Some Articles Which Will Appear in the December Issue

Outline of the Problem of Radio Control. By Olle D. Engstrom.  
Observations at the Receiving End of the Radiophone. By W. A. Knight, M.E.  
Crystal Detectors and Their Possibilities as Amplifiers and Oscillators. By John W. Million, Jr.

Simplifying the Radio Receiving Set. By James Ashton Greig, B.S., E.E.  
The Radio Controlled Airplanes. By Maurice Percheron.  
Construction of a Super-Heterodyne Receiver. By F. de Willy and R. E. Lacault.

# The Nerve System of the Sea

By J. FARRELL

Secretary of the Navy Denby Broadcasting Through Station NAA Direct from His Office in Washington



**T**O most people the picture of the Navy in time of peace is one of fleets riding lazily at anchor, of linen-clad officers sipping ices under tropical skies, of sailor lads on shore leave exploring the bazars. But back of the picture, unseen, a vital force is pulsating. A nerve system—radio—that penetrates every corner of the globe is aquiver, ready to summon protection and aid in every conceivable maritime emergency.

"Radio, not alone in war, but in time of peace, contributes greatly to the constructive work done by our Naval organization."

Edwin Denby, aforetime gunner's mate but now Secretary of the Navy of the United States, is speaking.

"Without radio," he continued, "our work in promoting the development of foreign commerce through the protection of American merchant ships would be greatly hampered. Maritime losses have been greatly decreased through the use of radio in warning ships of impending danger in darkness, fog or storm, of icebergs, in broadcasting weather forecasts and sending out compass bearings to ships making port with difficulty. The giving of aid to sufferers of shipwrecks, earthquakes, fires and plagues in time to be of real service would be in many cases difficult, if not impossible, without radio."

It was an American naval vessel that told the world by radio that Smyrna was burning and summoned aid from all over the seas. In the Messina disaster, in the epidemics in Panama and Southern Globe countries, Naval radio has played a leading part in bringing succor to the distressed.

"Through timely warnings," Secretary Denby told me, "made possible by radio, and through its relief work, made more effective by radio, the Navy has saved the lives of many thousands of people."

The Secretary then outlined the many activities in his Department in which radio is now playing an important part. The radio work is centered in what is known as the Naval Communication Service. All methods of visible and invisible communication are employed, including telegraph, telephone, cable, radio telegraph, radio tele-

phone, radio compass, flag and under water signals, sound telegraphy, pigeons, couriers and the mails, but of these the radio telegraph is regarded as the most important and most extensive.

Use of radio by the Navy dates back to

1899 when Professor Marconi brought three radio sets from Italy to report the International Yacht races between the Columbia and the Shamrock. Two ships and a torpedo boat were placed at Professor Marconi's disposal and a shore station was established at Highland Heights, New York. Every radio fan will recall the successful outcome of the venture. Rapid progress in the use of radio by the Navy was subsequently made, until today the Navy owns more than 40 high power stations capable of working distances of from 800 to 6,000 miles, and 95 intermediate stations with ranges up to 800 miles. Including radio equipment on ships and aircraft the radio system represents an investment of approximately \$25,000,000.

In time of peace, liberal use of the communication service is extended to the press and business interests, particularly when interruption occurs to commercial cable or radio systems. Incalculable assistance is given mariners through the broadcasting of time signals, weather reports, storm warnings, hydrographic reports and S O S signals. All Naval radio stations listen for a period of three minutes out of every 15 for distress signals, and when one is heard, the information, together with the location of the disaster, is broadcast on high power.

The radio compass is regarded as the most important recent addition to the service. Fifty radio compass stations are now located along the Atlantic and Pacific coasts and in foggy and hazy weather furnish

(Continued on page 618)

A View of the Antennae on the New Electric Driven Battleship "Wyoming." All of the Transmitters and Receivers Are Located Within the Protective Area of the Armor Plate. The Radio Equipment Aboard This Ship is the Most Complete in the Entire Fleet.

© K. & H.

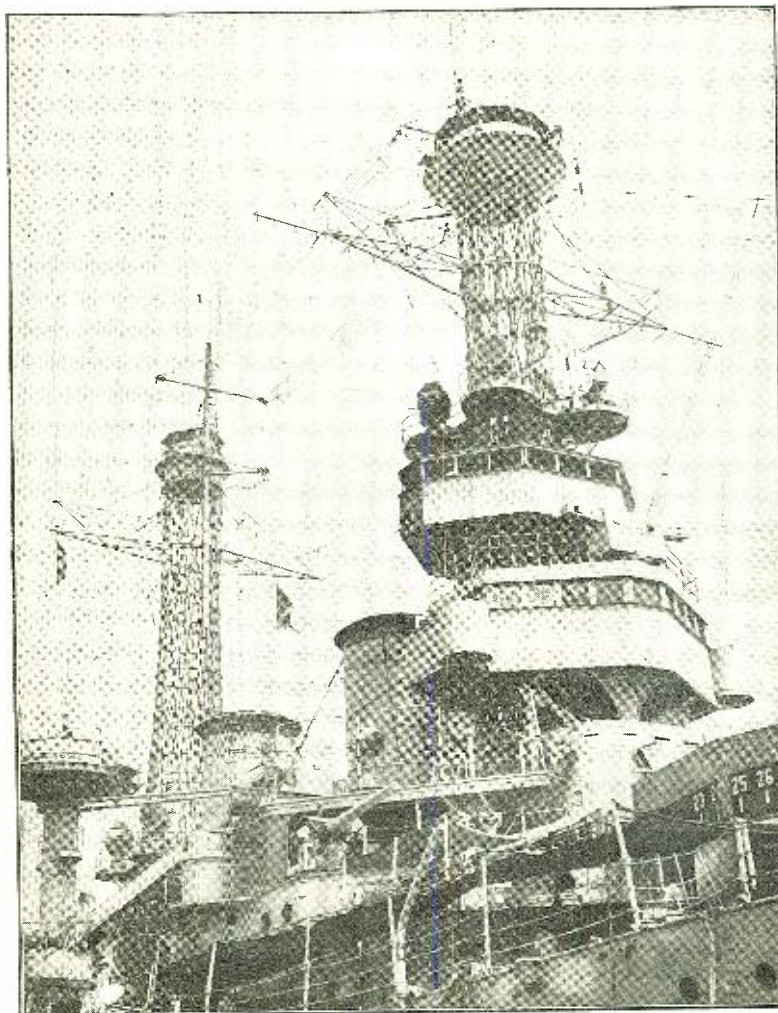

# Eliminating Static with the Resonance Wave Coil

By S. R. WINTERS

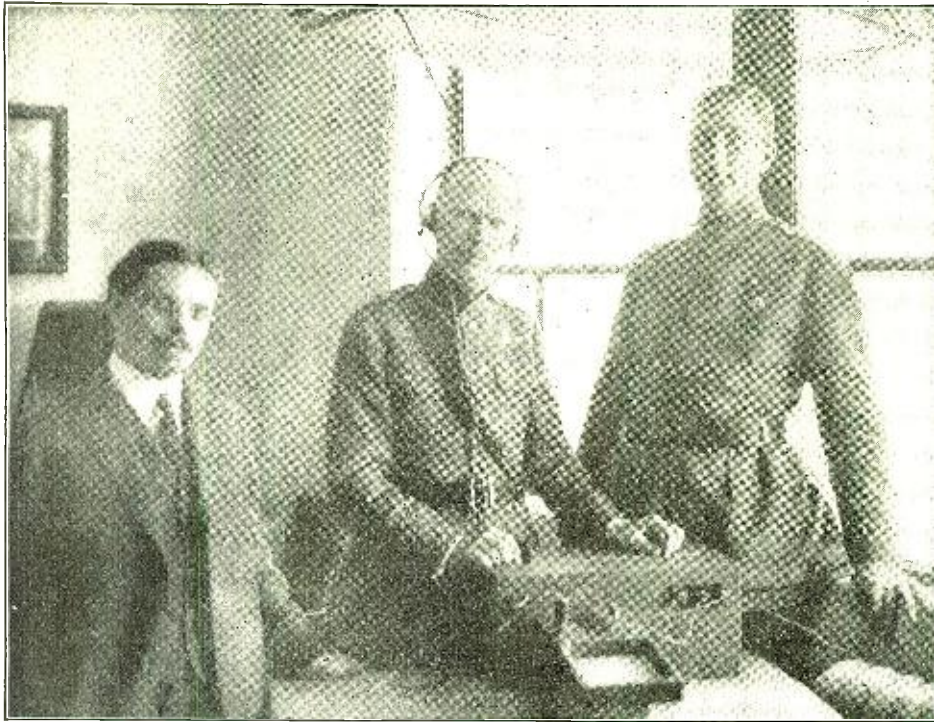

The Engineers Responsible for the Development of the Resonance Wave Coil. Left to Right Are Dr. Louis Cohen, Consulting Engineer, Major General George O. Squier, Chief Signal Officer, tuning in with the Resonance Wave Coil, and Lieutenant Colonel J. O. Mauborgue, of the Signal Corps.

**T**HE divorce proceedings instituted for the separation of orderly radio signals from "static" or atmospheric disturbances, to employ a figure of speech, are stubbornly contested. The union of the two electrical forces is of such close affiliation and of such long duration that the annulment of their wedding is challenging the supreme efforts of the scientific minds of today. The plan of attack in the main, to somewhat mix my metaphors, involves the relaying to the ground of "hog-chaining" of the rambling, crashing noises at the radio receiving stations while the purified signals proceed to the head telephones.

The partial elimination or subduing of atmospheric disturbances, in the majority of instances, has involved the draining off of such distracting noises at the receiving points, separating them from the orderly wireless signals before the latter reach the ears of the listener. If we could compare electro-magnetic waves and the attendant "static" or atmospheric disturbances to a liquid—a characterization suggested by the term "flow of electricity"—it would be permissible to describe the separation of the meaningless noises from the uniform sounds as a filtering process. The latter term implies the straining of a liquid or gas either for the purpose of purifying the fluid or collecting the suspended matter.

"Static eliminators", drain coils, resonance wave coils and other forms of appliances for reducing atmospheric disturbances, with certain modifications, adhere to the principal of draining or filtering "static" at the radio receiving stations. Notably among the comparatively recent inventions, or application thereof, for minimizing the bane of radio telegraphy and telephony is the adaptation of the resonance wave coil, a compact form of antenna, to the specific purpose just outlined. This device, an

invention of the Signal Corps of the War Department, has been recently subjected to a series of experiments under the direction of Dr. Louis Cohen, consulting electrical engineer of the Signal Corps, the developments of which application will doubtless invite the adaptation of similar devices by radio amateurs who are perplexed with the seasonal atmospheric disturbances. The resonance wave coil, as well as its application in eliminating "static", should challenge the interest of the experimenter.

The original resonance wave coil designed by the Signal Corps of the War Department, and described by this writer in the September, 1922 issue of RADIO NEWS, consisted of a hollow cardboard tube, 38" long and 2 3/4" in diameter. Wound around this tube was a single layer of No. 32 gauge insulated wire, affording about 100 convolutions to the inch. Terminal binding posts were placed at each end of this tube for making connections with various radio-receiving instruments. A brass band or ring, approximately 1/4 the length of the coil, is supplied with the binding post. This band or ring is not continuous, being split apart 1/4" at a point opposite to the binding post. This ring, just large enough to slip snugly over the wired coil or tube, has a split in it to avoid the possibility of the development of annoying eddy currents.

However, when a resonance wave coil is employed in the capacity of suppressing atmospheric disturbances, there is no arbitrary requirement with respect to the size of the wire or method of winding same. The experiments of the Signal Corps, which have been confined to the reception of communications on long wave-lengths, have involved the use of coils constituting single layers, others in banks, and still others in sections of 1"; each section is banked. Dr. Louis Cohen, who has adapted the resonance

wave coil to the suppression of atmospheric disturbances, suggests that in the reception of signals on a wave-length of 200 meters, a coil wound double-banked on a four-inch cardboard tube 10" long is suitable. No. 30 B. S. gauge S. C. C. wire is suggested, but this recommendation is not arbitrary. For the reception of music and speech from broadcasting stations, ordinarily operating on wave-lengths varying from 200 to 600 meters, a single layer of No. 30 B. & S. gauge wire, 18" long, on a cardboard tube 3" or 4" in diameter, is worthy of a trial.

The principle governing the operation of the resonance wave coil may be explained in this way: The cardboard tube around which is threaded insulated wire also contains a ring of metal which forms a capacity connection to the coil itself, yet insulated therefrom in other particulars. This circular band, described by the Signal Corps as a "collector ring" because of its ability to assemble or collect electro-magnetic waves, is enabled to take the voltage from the particular point on which it is located and transfer it to the grid element of the vacuum tube. This sliding ring, by reason of its movability from one point to another on the resonance wave coil, is capable of obtaining various wireless signals. By use of two such metallic rings, involving the services of two radio operators, signals may be obtained from two broadcasting stations, operating on different wave-lengths, simultaneously. This is accomplished by placing both metallic bands on the same resonance wave coil, with each operator connecting the grid element of an electron tube to one of the rings.

The resonance wave coil when functioning in the capacity of reducing atmospheric disturbances involves the use of a so-called "guard tube". The latter, which may or may not be slit, is from one-half to one-third as long as the resonance wave coil itself. The "collector ring" is located at the opposite end of the resonance wave coil. If the "guard tube" is "grounded" it appears feasible that it will capture all of the wireless voltages that strike the coil and that no electric impulses will find their way to the opposite end of the coil where the metallic ring is stationed. This theory squares with the practical results. That is to say, the signals are eliminated.

(Continued on page 629)

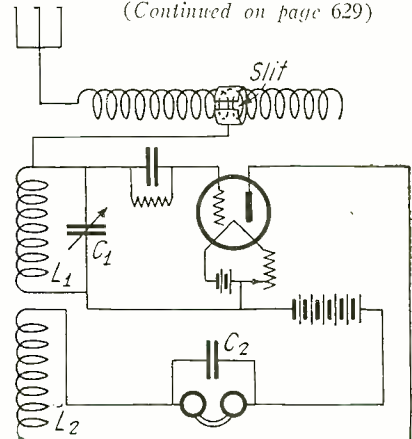
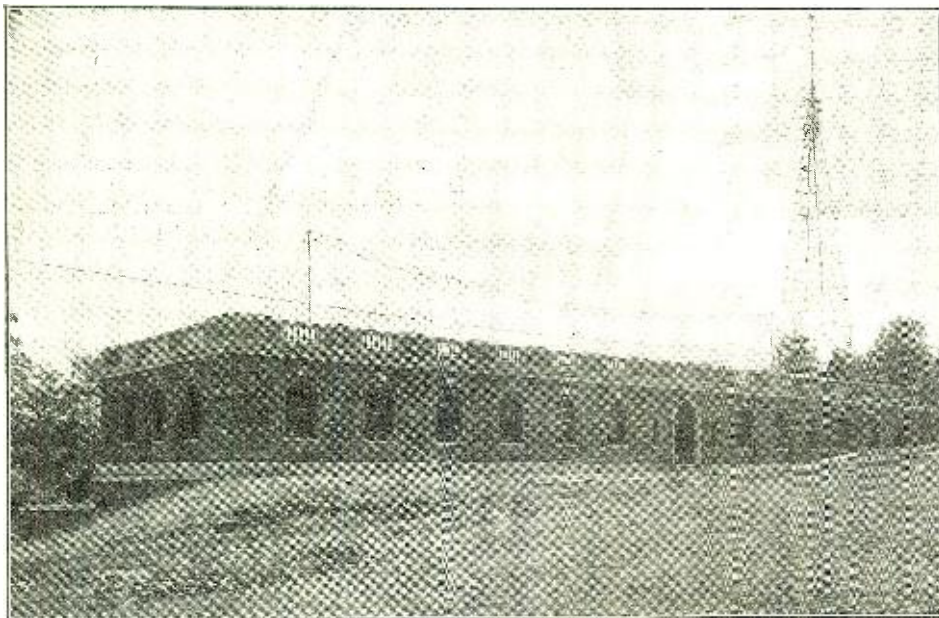

Fig. 1

The Resonance Wave Coil May Be Used with an Ordinary Regenerative Circuit When Connected as Shown Above.

# What Uncle Sam Is Doing for the Amateur

By S. R. WINTERS



A Photograph of the Bureau of Standards Radio Laboratory At Washington, D. C. The Large Lattice Work Tower Supports the Antenna of WWV.

IF EACH one of the thousands of radio amateurs in the United States—real experimenters, that they are—could have placed at his disposal for one year the Radio Laboratory of the Bureau of Standards, United States Department of Commerce, there would be no occasion for him to seek Elysian fields or to covet paradise! That is to say, this low-set building fringing on the outer border of the grounds of this Government Bureau, with antenna towers at either end of the structure, is a veritable workshop for the advancement of the science of radio telegraphy and telephony. The facilities accessible, while not adequate to the sundry radio problems being attacked, are the most elaborate in the possession of any branch of the Federal Government.

Since, however, it is an improbable situation of the radio amateurs obtaining a lease of these facilities for a 12-month period, or even for any great number of this vanguard of radio progress to visit this workshop, the Radio Laboratory of the Bureau of Standards is, in a measure, taking the results of its efforts afield. This dispersion of knowledge, resulting from the testing of radio instruments, the determinations of wireless, and whatnot, does not take the form of a question-and-answer office. The laboratory staff is unable to cope with such an undertaking and the appropriation of \$40,000 for the present fiscal year is far inadequate. However, the fruits of the research of this laboratory—the results of the major problems tackled—are accessible to the radio amateur, whether he resides near the hub of amateur activities, the A.R.R.L. in Connecticut, or maintains vigil at a light station, with a rock as a base, in the Pacific Ocean.

So, when I propounded the question, "What is Uncle Sam Doing for the Amateur?" to Dr. J. H. Dellinger, chief of the Radio Laboratory of the Bureau of Standards, he referred my attention to a chart, tacked on the wall to the right of his office desk. A glance at this outline—a program of activities for the present fiscal year—indicated that each member of the laboratory staff was then actively engaged in ferreting out one or even a group of problems, whose solutions would inure to

the benefit of the radio amateur, either directly or indirectly. From the making of electron-tube life tests, with particular reference to the determining of the periods of usefulness of receiving vacuum tubes and audions employed for low-power transmission to the measuring of the width of electro-magnetic waves of various stations, the testing and standardizing activities of this laboratory are well-nigh exhaustive.

At the time of the visit of the writer to this Government workshop, there was in progress a series of experiments for determining the receiving range of various types of wireless receiving sets. Two blanks are being supplied for the purpose of outlining these observations. One of these blanks is for the purpose of denoting the kind of circuit used, the type of antenna, kind and number of stages of amplification, location of station and whether surrounded by buildings or in the open country. The other sheet makes inquiry into such conditions as the severity of fading, the average signal strength, and whether one or more of these obstacles are encountered—atmospheric dis-

turbances, amateur damped wave "spark" interference, commercial station interference, interference from other broadcast stations interference from other receiving sets, and interference from power lines. While the distance over which radio transmission is conducted is dependent upon the twofold equation of the power of the transmitting apparatus and the sensitivity of the receiving instruments the results of this survey will afford an intelligent basis for computing the distances over which speech and music may be heard under certain conditions. One hundred amateurs and others are volunteer observers in these tests.

## WWV SENDS STANDARD WAVES

The transmission of radio signals of standard frequency, a service which has been in progress for some time is not only to be continued for several months, but the means whereby amateurs may check their wavemeters and adjust their transmitting and receiving apparatus are to be expanded. The Radio Laboratory of the Bureau of Standards has completed arrangements with Professor H. J. Ryan of Leland Stanford University whereby signals of standard frequency will be sent from the latter institution for the benefit of amateurs on the Pacific Coast. Arrangements are also being made for the transmission of radio signals of standard frequency from a Minneapolis broadcasting station through the Middle West. Heretofore this service has been confined to the territory east of the Mississippi River. At this point it is pertinent to make known the fact that this Government bureau has recently designed a radio-frequency indicator for broadcasting stations. Information and blueprints describing how to construct this instrument may be had on request to the Radio Laboratory, Bureau of Standards, Washington, D. C.

The intensity of radio signals and field intensity measurements, is another subject of major importance to the Bureau of Standards in furtherance of the science of radio. Dr. L. W. Austin, until recently identified with the Naval Radio Research Laboratory, is now attached to the Radio Laboratory of the Bureau of Standards in the immediate capacity of studying the problem of signal intensity. It is not far-fetched to contemplate that the transmission of radio signals of standard frequency—resulting in broadcasting stations keeping within their assigned wave-lengths—and a study of sig-

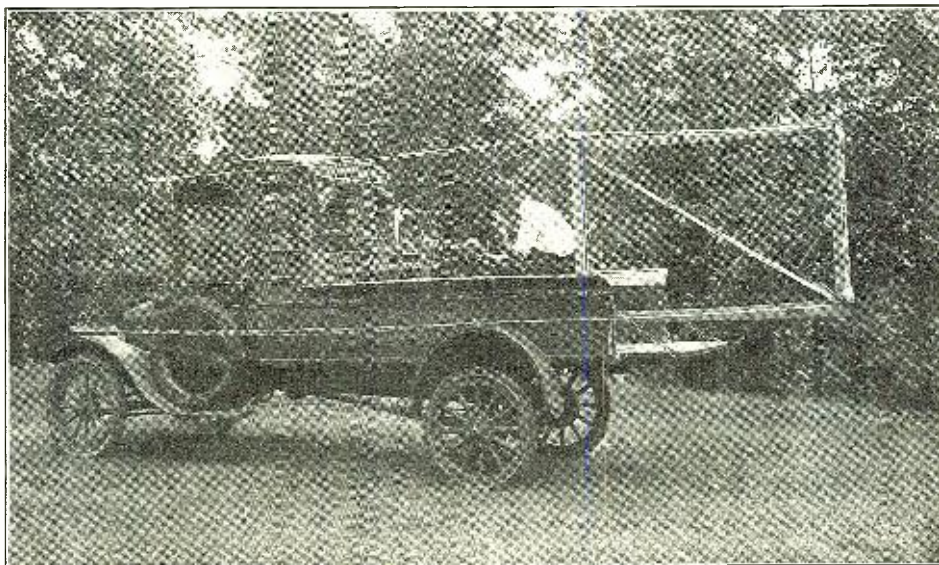

Making Tests of a Radio Transmitter and Receiver Designed For Use On Life-Saving Boats of the Coast Life Guard Service.

nal intensity, may ultimately result in the elimination of much of the existing interference in the air.

Methods and apparatus for determining the interference of modulated waves (voice and music modulation) are being developed. Also filter circuits are in contemplation for the elimination of interference due to the presence of electric-power lines. A new instrument is also being developed for the rapid measurements of radio frequencies.

Only recently the Radio Laboratory of the Bureau of Standards conducted tests looking to improvements in the manufacture of radio receiving sets. The results of these experiments are available in the mimeographed form, although the limited number of copies are reserved for distribution to testing laboratories, manufacturers, and others who are directly interested in the testing of receiving sets. If the observations made are carried into effect by the manufacturers both electron-tube and crystal-detector receiving outfits should be of improved construction in the future. Various types of receiving sets are being tested.

Broadly speaking, the 1923 program of this radio laboratory with reference to standards is concerned with the improvement of frequency measurements and its application to the standardization of wavemeters. These efforts, in the final analysis, will assist the radio amateur and others in accurately adjusting their transmitting and receiving instruments.

The research problems embrace studies of radio signal intensity variations, the distance range of radio stations, atmospheric disturbances, a study of the properties of insulating materials, and the regenerative action in electron-tubes. Of the latter subject, this study will seek to ascertain how much amplification is actually obtained from a regenerative circuit and whether or not regenerative radio sets re-radiate.

**ARC TRANSMITTER IMPROVED**

While the radio developments of the United States Navy Department are primarily concerned with the devising of means of communication on battleships and other craft in the times of national emergency, the fruits of this research not infrequently rebound to the benefit of the radio amateurs. Just at this time, this Government Bureau is expending approximately \$150,000 in modifying the transmitting apparatus at its high-power stations toward the end of eliminating "mush" and "harmonics." These forms of interference have, in a way, bridled the efforts of the radio amateur in his endeavors toward a full realization of the possibilities of radio. Recently, the Navy Department has reduced interference at the low-power transmitting arc and spark sets by the installing of a suitable circuit at one station and the installation of a tube transmitter at the other. On the Pacific Coast, specifically at the Naval radio stations at San Francisco and San Diego, interference created by arc transmitters has been over-

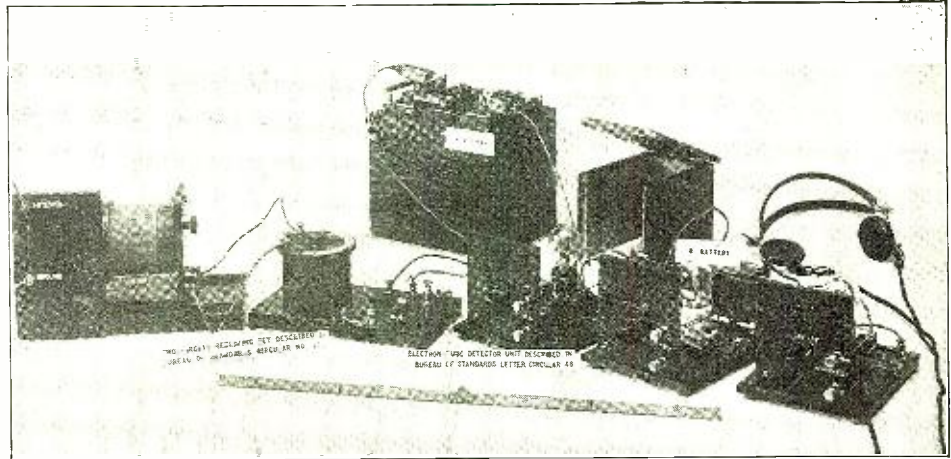

Apparatus Designed and Specified By the Bureau of Standards, Described In Their Letter Circulars Published For the Benefit of Those Who Are Desirous of Building Their Own.

come by the installation of a so-called nodal-point current transformer circuit. The high-power arc transmitters at Annapolis, Maryland, and Sayville, New York, are being subdued or at least the interference therefrom,

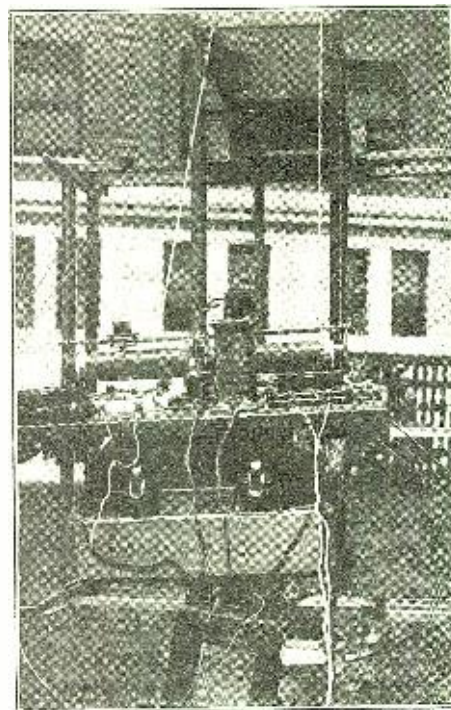

The Apparatus Used In the Experiments On Coil Antennae.

by similar modification or installation of special circuits.

The development of a system whereby one antenna will serve four or five radio receiving sets; the use of a kite-form of antenna

on small water craft; the perfection of new instruments such as vario-couplers antenna selector switches and condensers, are among the other fruits of research in the Radio Division of the Navy Department that are of indirect if not direct, benefit to the radio amateurs. The naval aircraft laboratory has developed a system whereby two or more messages may be sent from the same antenna. The amateur who is prone to experiment with equipment under water will be interested in knowing that the Navy Department has been able to receive signals from an underwater piloting cable at heights up to 1,000 feet. A radio compass has been developed that is so compact that small as well as large aircraft may be thus equipped in the future.

**STATIC ELIMINATOR DEVELOPED**

The Signal Corps of the War Department, too, is primarily interested in the development of radio telegraphy and telephony only as it pertains to military tactics, and to that extent makes for national security. However in the unfolding of these developments in the laboratories of the Signal Corps both methods and instruments primarily designed for military purposes may have peace-time applications. A notable instance is the resonance wave coils which are now being applied by Dr. Louis Cohen, consulting engineer of the Signal Corps, in suppressing "static" or atmospheric disturbances. Radio amateurs are tremendously interested in the lifting of this ban which is throttling the progress of radio, and resonance wave coils are being investigated toward that end. The modification of the Morse telegraph code, recently proposed by Major General George O. Squier, is another case at point—where a military bureau makes a discovery of benefit to peace-time industries. The use of this modified Morse telegraph code, by utilizing certain bands of frequencies not now employed in radio transmission, will help relieve the tensity of the atmosphere which is now charged with so many disturbing factors in the form of interference of one kind or another. The radio research laboratory of the Signal Corps at the Bureau of Standards, recently became active after a brief period of inactivity, and the adaptation of the proposed modified Morse alphabet is being studied with the view to practical application.

A noteworthy instance where the Signal Corps of the War Department and the thousands of radio amateurs of the country are joining hands, is indicated by the announcement of Captain R. B. Woolverton, officer in charge of the radio plant and intelligence division of the Signal Corps, to the effect that the two forces are to unite in contemplation of any emergency. The headquarters of each corps unit of the nine corps areas of the Signal Corps is to be tied into all of the special stations of the

(Continued on page 588.)

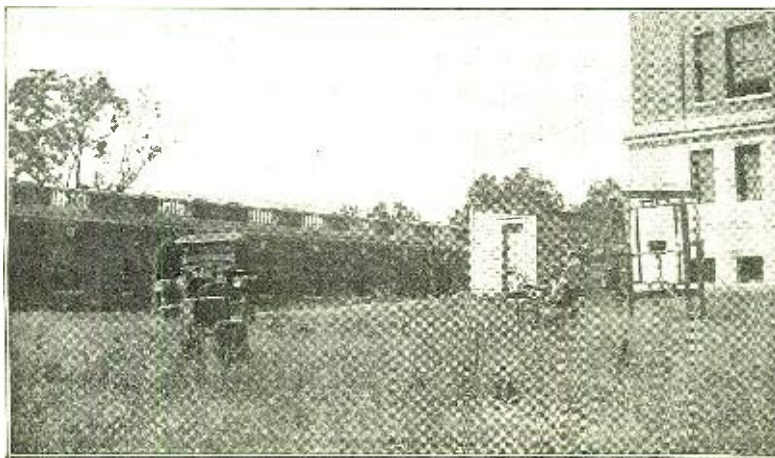

Experiments On Coil Antennae Constants, Which Tests Will Indicate To Amateurs the Size and Kind of Coils Most Suitable For Receiving Or Definite Wave-Lengths.

# Electrons, Electric Waves and Wireless Telephony

By DR. J. A. FLEMING, M.A., D. Sc., F.R.S.

## Part X

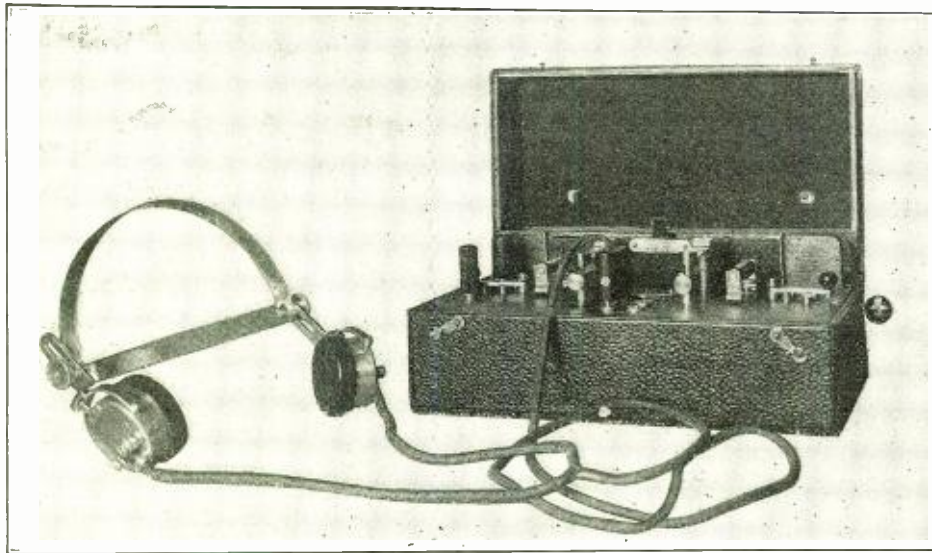

By permission of Marconi Wireless Telegraph Co., Ltd.  
Fig. 113. A Portable Crystal Receiving Set.

**T**HE type of set to be used must be determined by the distance and power of the broadcasting station from which the service is given, and we may add, by the by, the depth of the purchaser's purse.

A comparatively simple equipment will do useful service if within a few miles of such station, but for large distances a more sensitive and therefore expensive receiving arrangement is required.

Then again there is the question of surroundings to be considered. If the receiver is to be located in the middle of a large town where it is surrounded by high buildings, especially those with metal roofs or built with steel frames and girders, then there is a large absorption of energy, and therefore a weakening of the arriving wireless waves. Most large modern buildings are constructed of a mass of steel joists and girders, vertical and horizontal, and with concrete floors. Also a mass of iron, water, gas, and electric light wires is included. All this vertical and horizontal metalwork causes great absorption of the energy of the electric wireless waves, especially those of rather short wave-length such as 300 to 400 meters.

On the other hand an isolated old-fashioned brick and timber house, right out in the country, is not subject to these deleterious effects.

Accordingly a receiver placed in the midst of such energy-absorbing buildings will have to be more sensitive, other things being equal, than one in a more advantageous position.

### TYPES OF AERIAL

Lastly we have to consider the facilities for erecting an aerial wire. There are two main types of aerial:—

- (1) An open wire aerial, and
- (2) A closed circuit or frame aerial.

The first type consists of a wire or wires which may be a bare single, or better, stranded copper wire, the lower end of which is connected to that terminal of the receiving apparatus marked "aerial," and the further end attached to an ebonite or porcelain insulator placed in some elevated position. The wire must not touch any wall, roof, or tree in its course.

The best arrangement when possible is to erect a flagstaff or small yacht mast in the garden of a house or on the roof of your

house or some neighboring building, and stay it with stout ropes, and then to fix to the top an ebonite insulating rod to the end of which is attached the wire, or better, pair of parallel wires, kept about four feet apart by wooden spreaders. The lower ends of

**T**HIS article is the last of a series by Dr. J. A. Fleming, F.R.S., which appears under the above title. It is a reproduction, with some additions, of the lectures on electric waves and wireless telephony he gave at the Royal Institution, London, in December and January, 1921-1922, for which RADIO NEWS has been able to secure the exclusive serial rights of publication in the United States. The articles are therefore copyrighted, and rights of translation and reproduction are strictly reserved.

these wires may be brought in through an ebonite tube fixed in a wall or window frame so that the receiving apparatus is within the house (see Fig. 111). This is called an outdoor aerial. The Post Office limitations as to length have been already given. A frame

aerial consists of a number of turns of wire generally insulated, wound on a square frame or cross of wood (see Fig. 112). This frame is supported so that its plane is vertical and can be turned round a vertical axis in any direction. This has the peculiar property that it receives most strongly waves traveling in the direction of its own plane. Hence it can be used as a directional aerial. The frame aerial is less sensitive, generally speaking, than the outdoor or wire aerial in catching wireless waves, and hence requires a more sensitive receiver, but it has the advantage that it is much less sensitive to vagrant atmosphere waves.

In the case of lofty rooms or public halls or churches, it is sometimes possible to erect an indoor aerial wire stretching two or three wires horizontally across the room some little distance below the ceiling, the ends of these wires being connected to insulators, such as ebonite rods, which are attached to fixed points on the walls. From these horizontal wires a down leading wire can be brought to the receiver, making what is called a T aerial.

The ceiling however, should be free from steel joints or metalwork.

### THE RECEIVING APPARATUS

Having obtained a license and erected an aerial, the would-be listener-in will then require receiving apparatus. Let him or her be content with small achievements first, and learn to manage simple apparatus before attempting to use more complex appliances.

The first step is to understand the limitations of various sets, and not jump to the conclusion that with a cheap crystal detector set and pair of indifferent telephones he can pick up speech or music from very distant stations.

The essential element in all receiving sets is a pair of good head telephones made by a firm with a reputation. It is not desirable to unscrew ear-pieces or take receiving telephones to pieces to see how they are made, or else it will not be easy to readjust them.

If the licensee is so fortunate as to have his receiving point not more than 10 or 15 miles from a broadcasting station, then it will be best for him to begin operations with a crystal receiving set, and an outdoor aerial. The set includes a tuning coil or aerial inductance, a variable condenser, a rectifying crystal, and a pair of high resistance head telephones. There are two terminals, one of which is connected to the base of the aerial wire, and the other by a thick bare copper wire to the nearest water-tap or pipe. For adjustments the makers' instructions must be followed. Do not, however, expect too much of such simple appliances.

For a listener whose nearest broadcasting station is distant say by 50 miles or less.

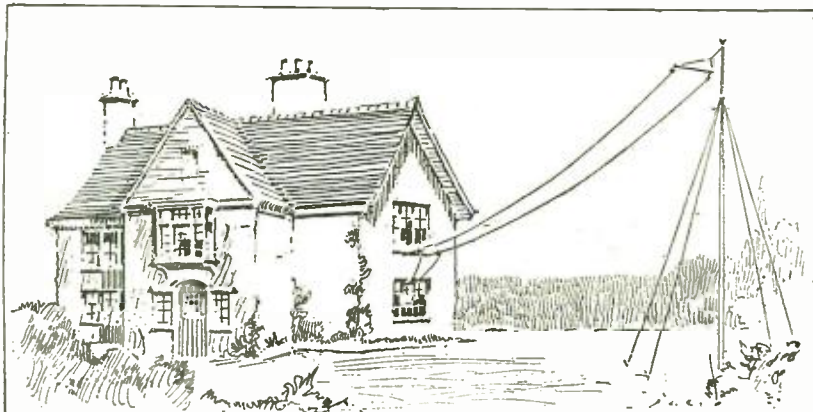
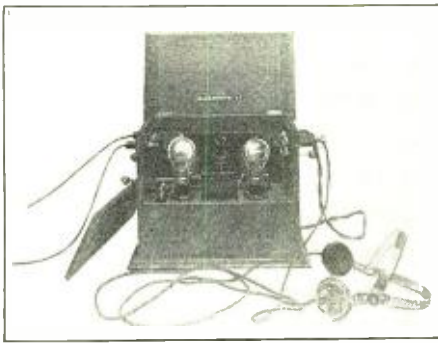

Fig. 111. An Outdoor Aerial, Consisting of Two Parallel Wires Extending from the Window of a House to the Top of a Mast.





By permission of Marconi Wireless Tel. Co. Ltd.  
 Fig. 114. A Two-Tube Receiving Set With Which Considerable Distance Can Be Covered.

a two-valve thermionic receiver set will be necessary when using an outdoor aerial. One of these valves constitutes the detector and the other the amplifier. The inexperienced user must then proceed cautiously and follow carefully the instructions of the maker or those in numerous little practical handbooks which have been published.

The valve is only a kind of electric lamp, and any mistake in putting too high a voltage on the filament will result in a burn-out, and then a new valve will probably cost 15s. to 17s. 6d. The set requires separate filament heating storage batteries and plate batteries, which must be re-charged as required.

For still longer distances a multivalve set is necessary, and the best type is the Unit System, in which each element of the apparatus is provided in a separate box or case which are joined in series as required. For details as to construction and management of these complicated receivers, and for the combination with them of loud-speaking telephones, special manuals must be consulted, and the user will only acquire the necessary skill to use such sets by painstaking work and by the study of wireless literature.

The best advice to the beginner is to join a local Wireless Society, and pick up from more experienced amateurs the necessary knowledge to get the best out of any receiver he can afford. He will in that way learn much which is not contained in any book, and the vagaries of "atmospherics," the difference between day and night reception, and sunset effects, as well as the acquirement of skill in tuning in or avoiding "jamming" will bring continual fresh interest. It is a wonderful art which has thus been evolved in the last ten years or so.

The development of wireless telephony is, indeed, one of the fairy tales of science, in which the wonderful thermionic valve takes the place of a modern Aladdin's lamp, annihilating space and making the whole of this terrestrial globe one vast auditorium in which a single voice can influence for good or for

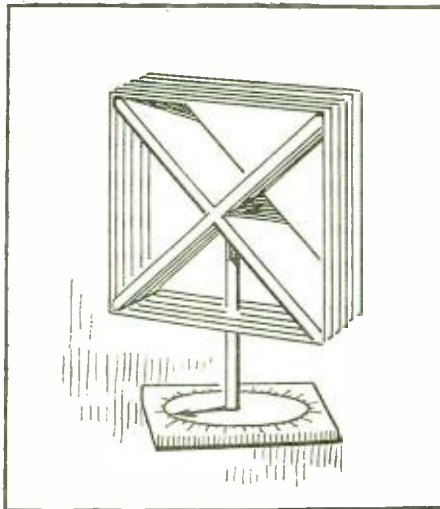
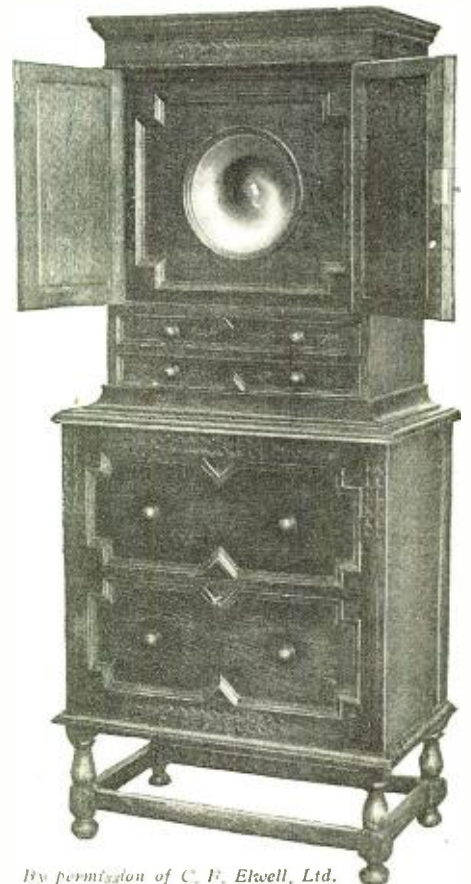

Fig. 112. A Receiving Aerial of the Loop Type.



By permission of C. F. Elwell, Ltd.  
 Fig. 115. A Cabinet-Type Receiver Having a Loud Speaker.

evil untold thousands of listening human minds.

THE END.

## It's Great To Be One of 'Em

By EDWARD T. JONES,\* A. M. I. R. E.

SITTING at ease in my home tonight, with a receiver and two-step amplifier connected to one side of my standing lamp through a condenser plug listening to the sad details of our President's death being broadcast from Fort Worth, Texas, my thoughts go back a number of years. In all, to the latter part of 1907 when, with my carbon detector set, completed only by the addition of one dead dry cell battery and a 75-ohm telephone receiver, I ran frantically out into the street to call all the neighbors into the house to listen to the 25-kilowatt station of the United Fruit Company, which was located about one mile from my home.

Tonight, I hear the announcer of the Radio Station at Fort Worth, Texas, read the details of President Harding's death, just as though he were in the same room with me, and that modern station uses but 1/2-kilowatt.

It also occurs to me that AMATEUR RADIO is the natural fruition of the good work done by Radio Magazines, in bringing into the home of every experimenter information and data which permitted the building or bettering of a radio installation, and painting simple pictures of the underlying theory.

Radio would not be what it is today in America if we had not had these land-marks—the Pioneer Radio Magazines. The very first Magazine in this country to publish data on radio was MODERN ELECTRICS, the fore-runner of RADIO NEWS.

MODERN ELECTRICS, dear to the heart of every old-time, dyed-in-the-wool radio ama-

teur brings back sweet memories of coherers, carbon detectors, electrolytic detectors, magnetic detectors, Fleming valves and what not.

By the latter part of 1909 I had made great progress in radio by very nearly eating every copy of MODERN ELECTRICS and had developed the station shown in the photograph. I had discontinued the use of carbon detectors and the like for the Pickard crystal detector. I had a noise-making spark coil used (to great disadvantage) by many well meaning amateurs in those history making days, a loose-coupler, which was a late development in tuning instruments—substituting rolling-pin coils. The special ball-bearing slider used on the primary of this coupler was designed, patented and manufactured by the Editor of this Magazine. There was an antenna-transfer switch which forced me during later years to de-



Mr. E. L. Commagere Seated Before His First Set. Note the Stationary Spark Gap and the Helix. Them Was the Days of Hi-Power But No Distance.

velop and patent a switch especially suited for that purpose. An old time single coil helix. Just in front of the helix can be seen four leyden jars, which no doubt accounted for 60 percent of the 90 percent losses, common to nearly all amateur transmitting installations during the early years when very little data regarding efficiency in station design could be found in print.

1911 found me floating on the palatial United Fruit Steamer *Heredia*, bound for the Panama Canal, which at that time was merely "in the making." During the years which have slipped by since that date, I have gone through the main plant of the United Fruit Company in successive stages of third operator, second operator and finally first operator. Gummer-Radio USNRF during the late war, Associate Editor of this magazine for the first six issues leaving that position only to return home in the capacity of Radio Supervisor-Gulf Division, U.S.S.B. After spending two years and a half in that capacity the Broadcast Boom picked me up on the crest of its wave and landed me where I am today, Manager, Radio Department Electrical Supply Co., New Orleans, La.

Everywhere I turn I am confronted by an old-timer who is today at the head of some radio organization. Amateurs are at the head of 99 percent of all there is in radio and there is plenty of room for those who have just recently made their "debut."

For example, let us take Mr. E. L. Commagere who erected his first amateur station in the year 1904. . . . most probably the very first amateur in this part of the country.

(Continued on page 582.)

\*Former Associate Editor of Radio News.

# Awards of the Reflex Prize Contest

First Prize

## A Regenerative Reflex Receiver

By HORACE B. PHELPS

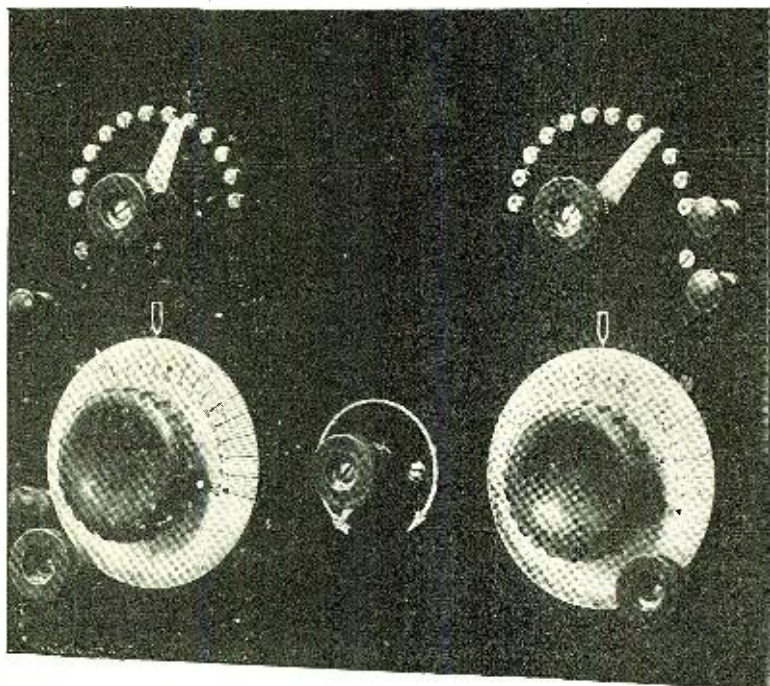

A Front View of the Completed Regenerative Reflex Set. Although the Switches Are of Importance, Most Adjustments Are Made with the Two Knobs and Dials.

on the inside surface of the tube: the secondary is wound on the outside and is tapped at every 3rd turn, beginning with the 20th, 12 taps being taken off. The crystal detector is a zincite-tellurium couple, and can be seen in the photograph on the shelf next to the transformers. The rectified signal is fed into the grid circuit through transformer  $T_2$ . It is best to use no by-pass condenser across the secondary of the transformer, and no grid condenser must be used, either. The tube fits into four holes bored in the bakelite shelf, and four brass springs make contact with the prongs. A 45-volt "B" battery is used, to get the best results. A list of the apparatus I had to buy follows:

Crystal Detector .....	Skyrad
Variometer .....	Raven
A. F. Transformer .....	Giblin
Rheostat .....	Paragon
Dials .....	Premier (Celluloid)
Variable Condenser, 13 plate,	
..... (No Maker's Name.)	
Vacuum tube .....	WD-11

The set has a range of about 1,000 miles. KDKA, Pittsburgh and WDAP, Chicago, come in nice and clear at Troy, N. Y. Nearer stations, such as WBZ, WEA, and WGY, can be heard with the phones six inches from the ears. The thing I like

**T**HIS set was designed primarily for receiving broadcast music, and in selectivity and signal strength will excel a plain regenerative set. It is a combination of the regenerative and reflex circuits, using a single-turn primary coupling, very tight coupling for the tickler, and a tuned radio-frequency transformer.

The primary is tuned by the tapped coil  $L_1$ , which has 48 turns, tapped every 4th turn. It is wound with No. 22 D.C.C. wire on a  $3\frac{1}{2}$ " formica tube. It is coupled to the secondary by the loop of bus-bar wire  $L_2$ , which can be seen in the photograph around the outside of the variometer.

The secondary inductance is the outside winding of the variometer. The secondary is tuned by the variable condenser. The variometer rotor is used as the tickler. The transformer  $T_1$ , which feeds high-frequency energy from the plate circuit into the crystal circuit, is made by winding No. 22 D.C.C. wire on a  $3\frac{1}{2}$ " formica tube: it is mounted on the shelf above the variable condenser. The primary winding of 10 turns is stuck

A Rear View of the Set Showing Clearly the Respective Parts. The Antenna is Coupled to the Secondary Circuit by One Turn of Wire Which Can Be Seen Wound Around the Variometer.

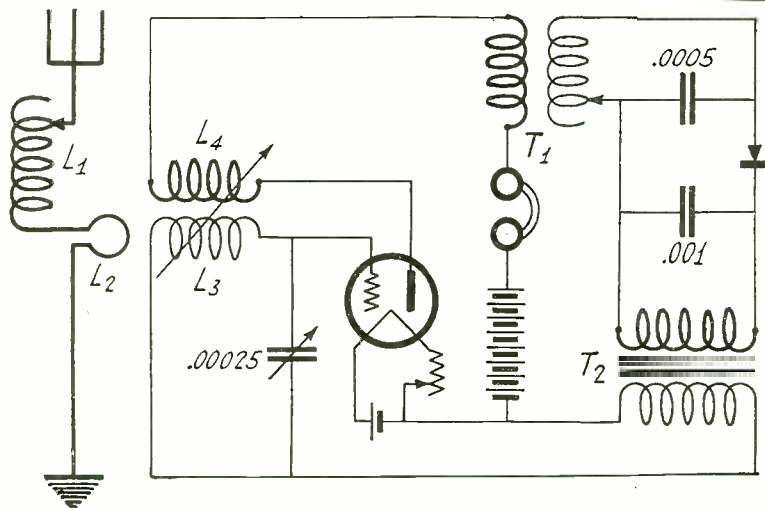
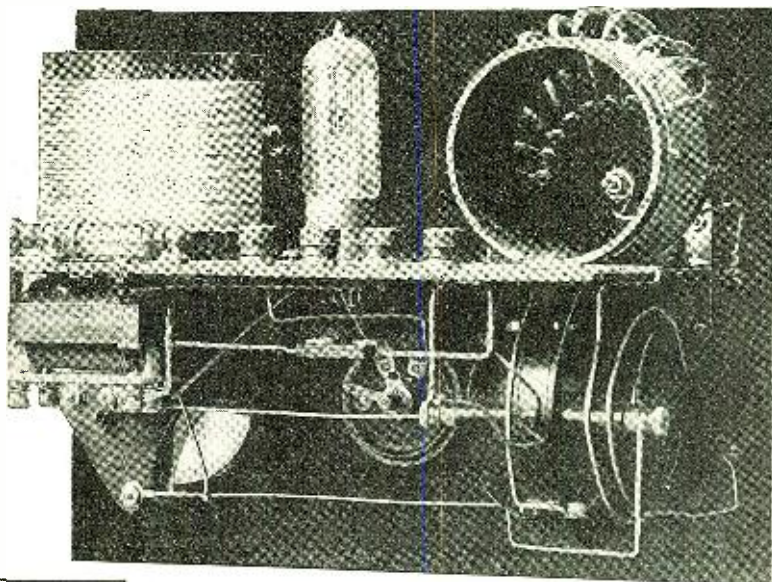

The Circuit Diagram of the Regenerative Reflex Set. Note that the Secondary of the R. F. Transformer is Tapped.

most about the hook-up, however, is the selectivity, which is much greater than that of an ordinary three-circuit regenerative receiver and which I attribute entirely to the single-turn primary. Another advantage of the single turn is, that the set can be allowed to oscillate without disturbing the neighbors by re-radiation. The reason for the increased selectivity is, that there is a very loose inductive coupling between the primary and secondary circuits, and the capacitive coupling, which in ordinary couplers broadens tuning, in this coupler is zero. The reason for the very slight re-radiation is the high turns ratio of the transformer, which gives a decided voltage step-down and makes the voltage applied to the antenna very low. The circuit diagram and the necessary information can be obtained from the accompanying illustrations

# A Single Tube Reflex Receiver

By DEAN S. KINTNER  
SECOND PRIZE

**B**ECAUSE of its compactness, relatively low cost of construction and upkeep, ease of adjustment, freedom from capacity effects, and large volume and unusual clarity of output, the single-tube reflex circuit, as it becomes better understood, should grow in popularity.

Adaptation of single-tube reflex hook-ups to standard instruments so as to achieve compactness of arrangement, simplicity and directness of circuits, and convenience of controls, presents many interesting and worth-while problems to the radio experimenter.

The set pictured and diagrammed herewith, while seemingly cantankerous at first, is giving such good service—the practical equivalent of that afforded by standard three-tube receivers—that other listeners-in may be helped by details of its design and operation.

No originality as to hook-up is claimed: in the main it copies the Erla circuit, which does not differ radically from other reflexing plans. Some embody a potentiometer, which I have not found essential: it adds a control, and complicates the rheostat's action to some extent.

To obtain greater flexibility over the new band of broadcasting wave-lengths, I use instead of a variocoupler two Giblin-Remler inductance coils on a Remler three-coil mounting, so attached to vertical wooden supports that the coils project toward the left, just above the primary condenser. Clearance between coils and condenser is sufficient to permit rotation of the condenser and variation of coupling by swinging the rear (primary) coil backward or forward. This can be done readily with the hand, since one of the fine features of this set is the almost entire absence of capacity effects, with resultant ease in tuning.

The tube base is placed just above and back of the secondary condenser, and just to the right of the coil mounting, so that the leads are short, direct, and free from close parallels or crossovers that might cause trouble.

Since the tube used is a 201-A, some cushioning against microphonic noises is desirable. In my set, which is mounted in a writing desk that is not subject to jarring, it has proven sufficient to suspend the tube socket by means of the leads thereto, which are of No. 14 round tinned copper wire. An additional advantage of placing the socket above rather than on the base is that connections are shortened, and the tube made more accessible.

An Atwater Kent radio-frequency transformer is giving gratifying results: I have never compared it directly with an Erla or other types. The audio-frequency transformer is a low-ratio (4 to 1) Atwater

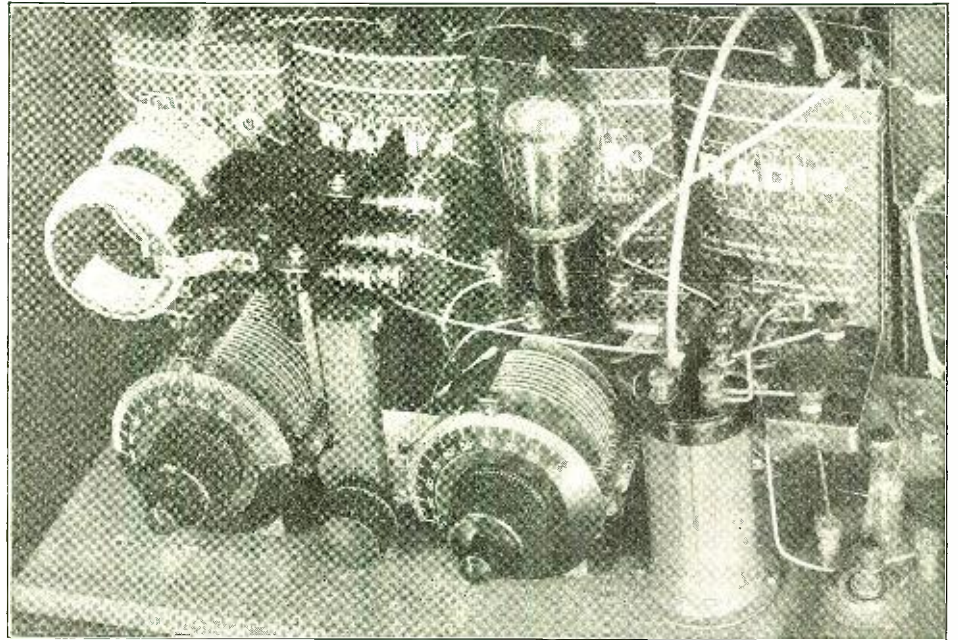

A View of Mr. Kintner's Reflex Set. The Instruments Are So Arranged as to Make the Shortest Possible Leads. The Disposition Allows for Panel Mounting if Desired.

## PRIZE WINNERS

**First Prize \$100**

**HORACE B. PHELPS**  
Rensselaer Polytechnic Institute,  
Troy, N. Y.

**Second Prize \$60**

**DEAN S. KINTNER**  
2560 E. 130th Street,  
Cleveland, Ohio

**Third Prize \$40**

**W. A. PYLE**  
2217 Washington Street,  
Wilmington, Delaware.

**Fourth Prize \$25**

**EVERETT G. BRUNDAGE**  
7 Pauncey Parkway,  
Buffalo, N. Y.

The number of entries received for the Reflex Contest were few. Out of these there were but four that the judges considered worthy of prizes. For this reason we have increased the amounts of the first four prizes so as to equal the original amount offered.

Kent. Its performance does not seem to differ much from that of a type, which is rated at 9 to 1. Reflex "fans" usually advise against high ratios on the audio side of the circuit.

The variable condensers are Bremer-Tullys, 43-plate and 23-plate, both with vernier. They are attached to the base of my "open-work" set by means of small brass brackets or corner braces in lieu of a panel, which could readily be used without redesigning the receiver. Vernier control is essential as regards the smaller condenser, since the tuning of the secondary circuit is exceptionally critical. The primary is broader, so that the vernier is seldom needed.

Tuning over a wide band of wave-lengths is facilitated by a new type series-parallel switch connected in the primary circuit and mounted on the rear support of the coil mounting. In using coils of various sizes with this switch it is desirable to keep a "log" of stations that have been heard. My log consists of a ruled sheet of paper with station names and call letters at the left, and spaces for noting each station's wave-length, the coils used (whether in series or parallel as regards the primary), and the condenser dial settings.

With my aerial and ground, approximating 175' in length, stations ranging upward from 360 meters come in nicely with a 100-turn primary coil in series with the primary condenser, and a 75-turn secondary coil. The same stations come in with about equal volume but broader tuning by using a 50-turn primary coil in parallel with the condenser. (The parallel connection will be found advantageous to those troubled with A.C. hum.) Broadcasting stations on lower waves are heard to best advantage with a 75-turn primary coil, in series, and a 50-turn secondary. Most amateur stations require a 35-turn primary, in series or parallel, and a 35-turn or 50-turn secondary.

The position of the primary condenser varies as the relative position (coupling) of the primary and secondary inductances is changed. Users of this circuit should find it advantageous to mark their log with coupling

(Continued on page 637)

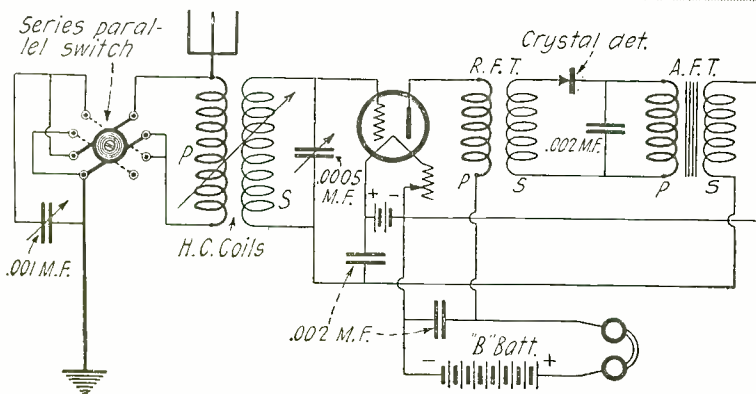

Circuit Diagram of the Single Tube Reflex Receiver. A Series-Parallel Switch is Used in the Primary Circuit so That All Broadcast Waves Can Be Covered.

# 100-Meter C.W. Transmission

By S. R. WINTERS

AN ACCOUNT OF THE EXPERIMENTS CARRIED OUT AT THE BUREAU OF STANDARDS

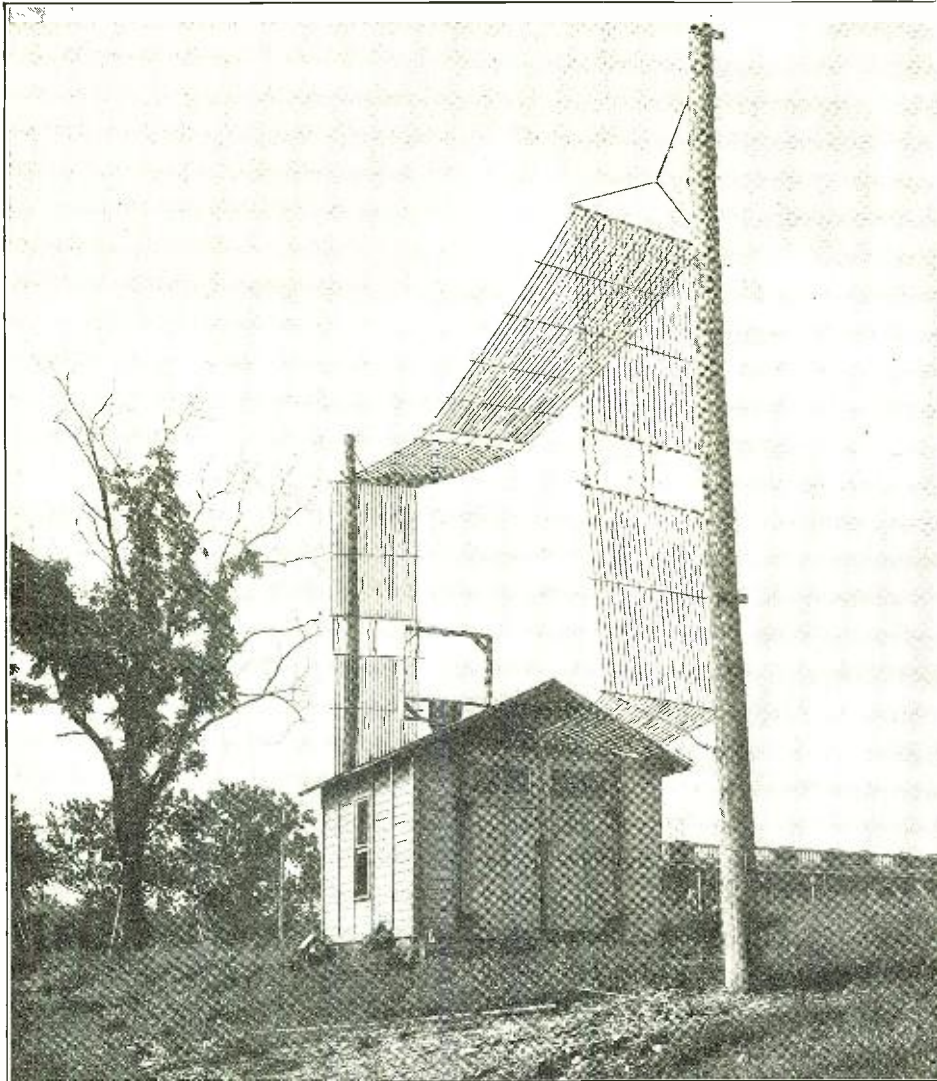

The Special Antenna Used by the Bureau of Standards During the 100-Meter Transmission Tests.

**R**ESEMBLING a suspended latticework, an antenna designed and installed by F. W. Dummore and F. H. Engel of the Radio Laboratory of the Bureau of Standards, United States Department of Commerce, has made possible the transmission of radio-telegraph signals on a wave-length of 105 meters to a distance of 300 miles. Continuous wave transmission at wave-lengths exceeding 150 meters has been a subject of frequent experiments, but the sending of wireless signals at a frequency of 105 meters is a departure in radio communication.

#### SPECIAL LOOP AERIAL IS USED

Novel experiments demand unusual equipment. As seen in the accompanying photograph, the antenna used in this instance is oddly enough at variance with the type elevated above the roofs of residences and apartments and the loop antenna which may be placed in the corner of a room in complete harmony with mahogany furniture. This semblance of latticework, suspended above a house on the grounds of the Bureau of Standards, a structure usually reserved for tests with radio direction finders, is a hybrid antenna. That is to say, it is a combination of the capacity and coil types of antenna. The coil design, as previous experiments have determined, effectively radiates electric energy at abbreviated wave-

lengths and has directional characteristics.

As the illustration reproduced with this article shows, this antenna is comprised of a number of wires in parallel in the form of a rectangle with a gap in it. It includes a single-turn inductance coil and a condenser. The latter is formed by covering the two wooden spreaders with copper foil. The glass rods between the spreaders function as insulators. The parallel wires in this wave-radiating system are 23 No. 20 B & S gauge bare copper strands, connected in parallel and spaced 3" apart. Light wooden spreaders are placed at 4-foot intervals as a means of insuring the separation of the wires. The antenna, in completed form, is 18' high and 40' long.

#### MEISSNER CIRCUIT IS USED

The source of electric power is coupled at a point about the center of the lower horizontal section of the antenna. This combination type of antenna, with a 3-turn secondary coil connected in series, constitutes an electric circuit which operates on a wave-length of 105 meters. The electron-tube circuit bears similarity to the Meissner circuit. The type G, 50-watt capacity, transmitting tube, manufactured by the Western Electric Company, is employed; four of these are operated in parallel. This arrangement makes possible the "pumping" of six amperes of electricity, at a wave-length of 105 meters,

into the latticework-like antenna, for dissipation.

The vacuum-tube transmitting equipment operated more satisfactorily with 32,000 ohms shunted by a 0.002-mfd. condenser connected in the grid circuits than when dissimilar methods of operation were in force. A similar condenser shunted by a 50-ohm resistance in the high voltage supply circuit proved to be a stabilizing agent in the operation of the electron tubes. The primary or plate coil was composed of two turns of heavy copper strip, 2" wide, when wireless signaling was conducted at a frequency of 105 meters. This coil, shunted by a 0.002 microfarad mica-transmitting condenser, afforded the required frequency for the continuous wave transmission.

A 14-turn helix was employed for the grid coil. A tap at five and one-half turns from the center was productive of most satisfactory operation. The coupling between the grid and plate coils is described as somewhat critical. A secondary coupling coil was employed for the purpose of transferring the electric energy to the antenna. This coil, connected in series with the antenna, was comprised of three turns of brass strip, 1" wide. A chopper was used when interrupted continuous wave transmission was resorted to, the chopper being connected in series with the lead from the filament to the radio-frequency circuits.

#### TESTS CARRIED WITH 8XK

A series of five tests have been thus far conducted with this wireless transmitting outfit, which is capable of radiating at a frequency of 105 meters. Frank Conrad of the Westinghouse Electric and Manufacturing Company co-operated with the Radio Laboratory of the Bureau of Standards to the extent of having an operator at station 8XK of East Pittsburgh, Pa., listen in during the period of transmission of these signals on abbreviated wave-lengths. A detector and one-stage of audio-frequency amplification were used for reception, the signals during the first two nights being received at East Pittsburgh with an audibility of approximately 100. Two-way communication was maintained between the latter point and Washington, while a report indicates that the signals during these tests were heard as far distant as Boston. The signals were received at East Pittsburgh in the absence of fading when messages were transmitted after nightfall.

The gratifying success of the evening transmission tests prompted an investigation into the effects of short-wave signaling during daylight. Continuous transmission, therefore, was conducted at two periods, beginning at noon and continuing until 10 o'clock at night. Thus a relative comparison was made between the intensity of the wireless signals sent during the day and those transmitted after nightfall. Quite logically, it was anticipated that the signals would be weaker during the day than at night. Astonishing was the result, however, that the strength of the signals during the day and evening was the same, irrespective of the period of time at which messages were sent. The signal strength of 8XK was about 100 audibility. This surprising result apparently explodes the theory that the absorption of wireless signals at short wave-lengths is greater during daylight than after nightfall. The Radio Laboratory of the Bureau of Standards, however, withholds conclusions on this point until further experiments are conducted. It was raining in Washington and cloudy in East Pittsburgh on the day of the initial tests. The lack of fading, too,

was a gratifying observation, although conclusive evidence has not been obtained on this point.

The results of subsequent daylight-darkness experiments were on this order: Cloudy weather prevailed at both the transmitting and receiving stations. The signals were not clearly audible during the early afternoon. At 3:30 in the afternoon, however, with the sun undimmed at East Pittsburgh and with cloudy conditions in Washington, continuous-wave signals were heard with an audibility of 170. Interrupted continuous waves could also be received at this time. The strength of the signals exceeded that of those of the previous tests. Fading was noted at 8:15 in the evening, a period of time during which the phenomena is usually assertive on the commonly used wave-lengths. The audibility during this particular evening ranged from 200 to 300, with the interrupted continuous wave averaging about 100. The measurements of audibilities, however, are only approximate, due to the interference from power induction encountered at the receiving station.

The Radio Laboratory of the Bureau of Standards, accepting the results of these experiments as a criterion for judgment, concludes that radio-telegraph transmission at a frequency of 105 meters is altogether practical over a distance of 300 miles. This conclusion contemplates the use of the antenna

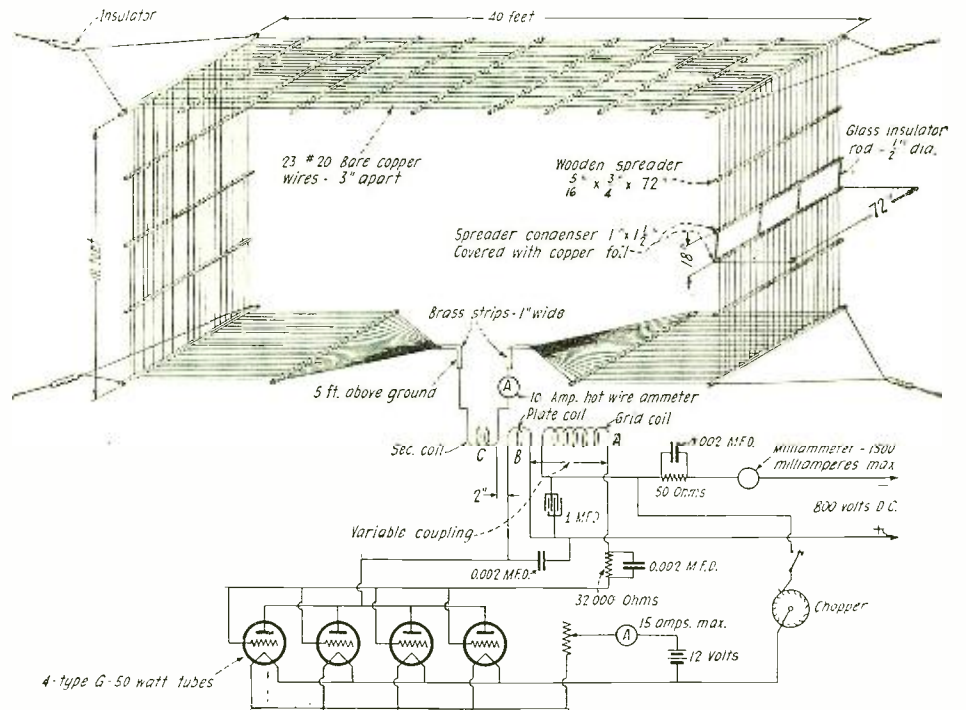

The Complete Circuit Diagram of the 100-Meter C.W. and I.C.W. Transmitter, Using Four 50-Watt Tubes.

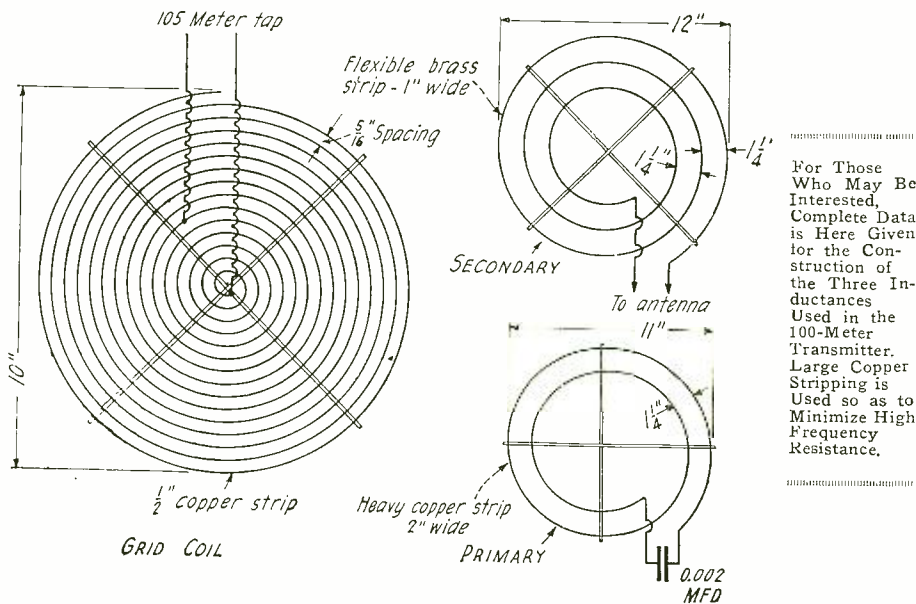

and electric circuits described in this article. The advantages of this system of transmission are marked—a reduction of the interference from atmospheric disturbances and by the use of a small coil antenna at the receiving station the annoyance from "strays" is lessened. These observations have particular virtue from daylight transmission when radio communication is difficult in the summer months by reason of the prevalence of "static."

From 10 to 150 meters is practically an undeveloped range of frequencies which offers possibilities for use. Another series of experiments by Dunmore and Engel have already determined the feasibility of employing a 10-meter wave-length for directive radio transmission. Now, with the devising of a method of continuous-wave transmission at 105 meters, between the leeway of 10 and 105 meters there is practically an untouched band of frequencies. The exigency of experiments within this realm is forcibly suggested by the crowded and jammed condition of audio-radio-frequency range between 200 and 600 meters, with the resultant babble of confusion in the air.

## The Amateur to the Rescue of the BCL

By KENNETH M. SWEZEY

ALTHOUGH pounding brass is a decidedly different diversion from listening to broadcast concerts, and the average amateur is a decidedly different personality from the average broadcast listener, the two have some things in common that bind them together, and it is to the advantage of both that amity and co-operation be cultivated. Up until this time the dissident factors have been exploited, instead of the likenesses, with the result that antagonism was promoted, and a hot and bloody war was kept fired with fuel. But it is high time now that the tide should change, the conditions understood, and the partial consolidation put forward. There is nothing to lose, and everything to gain, so, the sooner the better. We will talk to the amateur now, and with his capabilities and needs in mind, try to enumerate some of the things he could do to help the broadcast listeners, and at the same time help himself.

The amateur has certain prior rights, of course, but he must also realize that his experience makes him a sort of older brother to the newcomer in the field, and he must excuse some of the faults of the fan and try to help him to do better. In this lies the big chance of service for the amateur. On account of his superior technical training, he can act as an instructor and guide.

This service may be rendered by individuals, but probably the greatest results could be obtained through the amateur clubs. There is hardly a locality in the country, where a number of amateurs abide, in which there is not some form of organization. Here is a power where the amateur has it all over his broadcast brothers; he is organized, whereas they are not. Could not there be some sort of an associate membership, in which the BCL's could enjoy part of the privileges, such as practical operating instruction, elementary theory instruction, and

the designing and repairing of sets, without being bound down too tightly? Such a membership would mean more money and greater power to the amateur, because of the increased amount of dues and the increased numbers resulting therefrom. Additional money could be obtained for the treasury by maintaining a service station for the overhauling and the repairing of apparatus, and general consultation work. A description of some of the activities of one club that carried out this policy might be of interest and value to those who would like to follow suit.

This club at first had been strictly for amateurs, and as such it was red hot with life. Out of about 20 members, 15 were at least first-grade amateur operators, and several had first-grade commercial licenses. They had both a long-wave and a short-wave receiving set, and radio and audio fre-

(Continued on page 604.)

# A Low Power C.W. Set

By R. P. BALLOU, 9CAR

FIRST HONORABLE MENTION IN OUR C.W. CONTEST

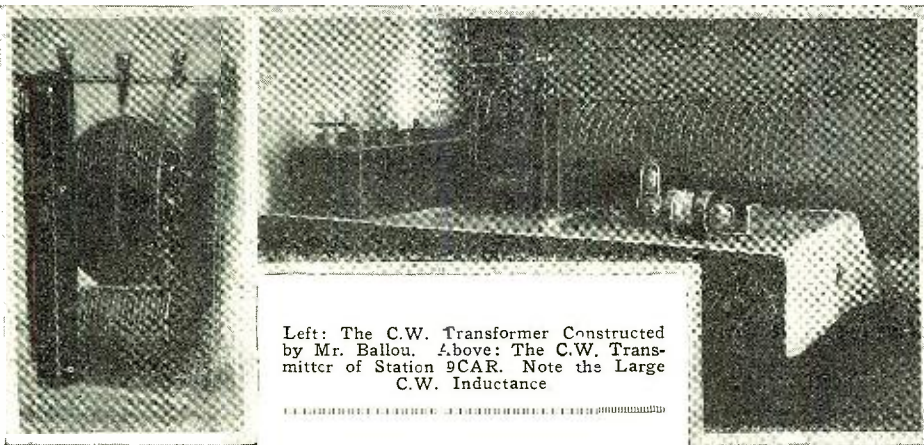

Left: The C.W. Transformer Constructed by Mr. Ballou. Above: The C.W. Transmitter of Station 9CAR. Note the Large C.W. Inductance

**T**HE following is a description of my home-made C.W. outfit, of which the most interesting and important part is the transformer. Therefore I shall give complete details of how I made it.

Now that spark sets are rapidly going out of style almost any amateur either has, or can easily obtain for a small sum, a one or one-half K.W. transformer. For a small sum I purchased a 1-K.W. Meteor oil immersed transformer for a starter, but nearly any make could be used as well.

I removed the top, disconnected the coil, and set it out to drain. By removing the bolts that clamped the core together the secondary leg was detached in about two minutes and the secondary coil slipped off easily without unwinding it.

I removed the secondary leg, wound it once around with a piece of cardboard and then with insulating paper and tape. On this I wound 30 turns of No. 14 D.C.C. wire, making two separate coils of 14 and 16 turns each, with a center tap on each.

This winding was then well covered with tape and insulating paper and a piece of heavy cardboard about 6" in diameter was cut to just fit over it snugly in the center. On each side of this were then wound 1,100 turns of No. 24 D.C.C. wire, taps being taken at 800, 900 and 1,000 turns, on each winding. This required three pounds of wire. (Three 1/2 lb. spools on each side.) The size of the wire is unimportant, No. 26 or No. 28 could be used as well, and fewer number of pounds would be required. Smaller than No. 28 will be found hard to work with however.

Both sides were wound in the same direction, so as to be in series when the two inside wires were connected together, this connection also forms the center tap. The entire coil was wound by hand but only required a few hours.

Every time I wound on one hundred turns I wrote 100 on a small piece of paper, thus making it very easy to count the turns.

Before winding several strips of tape were placed across the core endwise and allowed to extend out about 6" on each end. When the coil was wound these were drawn back over it and held it firmly together.

The entire winding was then saturated with hot paraffin and when cold the iron core was pulled out, the cardboard removed, and its space consumed by wrapping tape around the ring-like coil, passing it through the center each time. This completely bound the entire coil together. It was then snugly forced back on the core and the transformer re-assembled.

The method of holding the heavy wires in place while and after winding is shown in Fig. 2. To start the winding: First double the tape to give it added strength. Then lay it on core and place wire over the tape, and bend the tape back over the wire. Hold firmly, and wind a few turns of wire over the tape. This will hold it. When you get near the end of the winding finish up thus: Make a loop in the tape and wind over the tape, bringing the ends out between two turns near the end. When the last turn has been wound on, cut the wire and stick it through the loop. Then take the pliers and pull the loop tight over the end wire. Heavy cloth is usually better than tape for this last operation, since it will pull up easier.

Although the coil was rated at 1-K.W. it does not pull any more than is required to operate the set. When it is turned on the flicker of the lights is almost unnoticed, so if a regular filament transformer is also used the key could be inserted in the primary circuit without bothering the neighbors.

If any amateurs have trouble constructing a transformer of this type, I will be glad to help them in any way I can.

Now for the rest of my transmitter:

When the picture was taken everything was disconnected so the photo is not encumbered with wires, but the general layout is the same.

The inductance consists of 30 turns of No. 4 copper wire, in a coil 7 1/2" in diameter. I purchased this from a local dealer and mounted between a couple of strips of wood, which form a base.

The rectifier consists of 14 one-half pint fruit jars, with tops removed and mounted in the box as shown. The lead and aluminum strips are immersed in a solution of borax but I am going to change and use am-

monium phosphate very soon. I am using the center tap on my transformer positive. If it is made negative the two aluminum strips on the rectifier should be connected together instead of the lead ones.

Only chemically pure ingredients and distilled water should be used. They cost more, but are well worth it. Also, it makes the aluminum strips last longer.

When filling the jars after evaporation use only distilled water. Do not put in any more chemicals. The chemicals do not evaporate and the addition of more will only cause crystallization around the edges of the jars, which should be avoided. Fill the jars with a little water, often.

My antenna system is nothing unusual. The aerial is a 4-wire flat top, sixty feet long and forty feet high. Directly under it is a 4-wire fan counterpoise about twelve feet high. The aerial is composed of stranded wire and the counterpoise of solid wire. The aerial lead-in is No. 6 and the counterpoise No. 14. Physical conditions here are favorable except for a high wire fence a block away, which surrounds a large athletic field. But evidently not much of my energy is being absorbed by this, for I seem to be "getting out."

## A 10-Watt C.W. Set

By F. I. DOBSON, 2CQI

SECOND HONORABLE MENTION

**T**HE circuit used in the 10-watt set at 2CQI is the well known 1 DH or reversed feed-back. The set is built on a wooden base about 13"x11" and has a small panel about 5" high in front for the meters and tube rheostats. On this panel at the right is a radiation meter, zero to 5 amperes. At the left is a zero to 500 milliammeter in the plate circuit and just above it, is a jack to plug in the key. In the center are two Fada rheostats designed for 5-watt tubes. Behind the radiation meter is the main inductance of 37 turns No. 14 wire on a 3 1/2" tube with soldered taps at every turn. At one end of this inductance a small tube with 25 turns of No. 18 bell wire slides in or out of the main inductance and is also varied by means of a 43-plate Murdock variable condenser. Behind the rheostats on the panel are two Radio Corp. transmitting tube sockets and behind these is a Faradon .002 mfd. condenser, which acts as a bypass across the plate supply. At the left end of the base are five spring clips for filament and plate current connections. The power transformer for this set is an Acme 200-watt

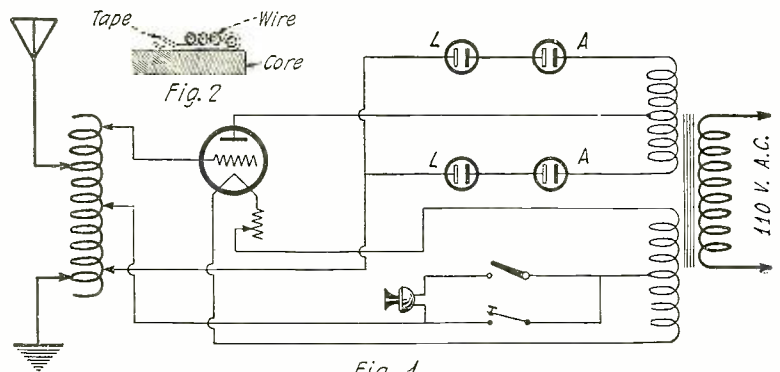

Circuit Diagram of the C.W. Transmitter at 9CAR. Fourteen Rectifier Jars Are Used All Together, Seven in Each H.T. Lead.

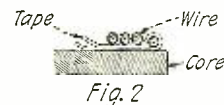

Fig. 1

used with an electrolytic rectifier of 26 jars and a 1 mfd. Faradon filter condenser. The set is wired with No. 14 copper wire with all connections soldered and is so wired that when the key plug is removed and a modulation loop used very good results are obtained on phone.

Another feature of this set is an extra resistance in the filament lead which is arranged so that the filaments burn half brilliancy while receiving. This is done by a third blade on the change over switch which cuts out the resistance while sending.

Usually best results are obtained by using a tuned ground in connection with a counterpoise. The aerial at present is only a single wire T about 96 feet long and 45 feet high. This set has some very good DX records, for instance 1,200 miles on 10-watt C.W., 1,000 on 5-watt C.W., 100 on 5-watt phone, and 1,400 on 5-watt C.W. although as yet this last report is unconfirmed. The set has been heard in 26 states and Canada.

2CQI Uses the Reversed Feed-Back Circuit. Both a Counterpoise and Ground Are Employed to Advantage.

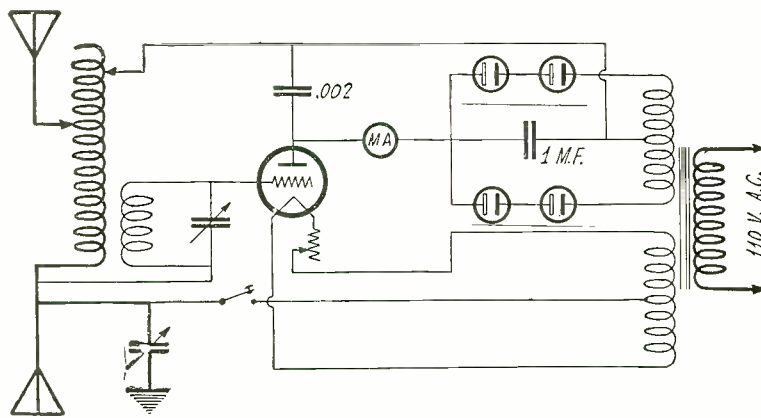

With 750 volts on the plates and about 7.5 volts on the filaments the radiation is 2½ amps. on 10 watts and 1.5 on 5 watts.

The 10-watt set has hardly ever been used because results are almost as good on 5 watts.

## A One-Tube Receiver That Brings Them In

By LEON W. BISHOP, 1XP

ONE of the most interesting and spectacular circuits for a single tube may be constructed for vacation use; it may be used in a car or at camp and requires little or no aerial. The circuit is the adaptation of two Armstrong principles and really produces distance and clarity for a small constructional cost.

The success of any circuit depends upon the constants used, particularly this one which would seem to be a standard regenerative circuit, but is completely changed by a large tickler and variable grid leak.

This circuit has been designed for the new wave bands of 2,000 to 550 kilocycles (150 to 545 meters) and includes the amateur. The circuit is more efficient on the shorter wave bands, so it is possible to get the class B stations as loud as the Class A, which is not possible with other types. Due to great flexibility, the circuit will work equally well on phone, C.W., I.C.W. and spark, which will insure all classes of service no matter where you are.

This one-tube circuit set up in a car with a 4' aerial, is equal to a three-stage radio frequency amplifier and detector. Due to the short aerial used it is possible to receive through bad static (QRN) and for this reason alone is of considerable value during the summer months.

### DESCRIPTION OF APPARATUS

The two best tubes to use are the UV-199 and UV-201A. The rheostat should be of that resistance advised by the makers of the tubes. The "B" battery can be anywhere from 45 to 90 volts. The two fixed condensers, .00025 and .002, should be of the mica type. The variable condenser should have from 17 to 23 plates (.0003 to .0005 mfd.).

The variable grid leak is important and should be variable over a range of from 50,000 to 5 megohms. Several commercial types that were tried did not have the correct range, so it might be advisable to build your own, and for that purpose purchase a ten-cent roll of Dennison's BLACK picture binding paper tape the dull black surface of which is slightly conducting and can be readily lowered with a very soft lead pencil. This grid leak can be arranged with a sliding arm or switch and contacts, but it must be variable over a wide range and capable of fine adjustment.

Like the grid leak, the coupler is of special design and the following values should be adhered to. The best combination to use is the rotor and stator of a standard coupler wound as follows: The tube (stator) should be wound with as large a wire as possible, starting with 20 turns on the rotor side of

the tube and tap off every 10 turns until you reach 120 turns, with 11 taps.

The rotor is also a real job, for it is tapped in a similar manner. Start on one side of the rotor with 40 turns and tap off every 10 turns until you have wound on 120 and you will have nine taps. These taps can be passed through the rotor shaft to switch points on the panel, or a switch may be mounted on the rotor. Fine wire may be used on the rotor to accommodate the 120 turns necessary.

A warning is issued against the use of shellac on the windings; firm windings may be obtained by drilling holes at each tap and binding the wires in them.

Do not use honeycomb coils. Either double or single switch arms may be used, and 180-degree type of coupler. Do not tap the coils any coarser than 10 turns, but finer if desired.

### OPERATION OF THE CIRCUIT

The best antenna or collector system is to connect the variable condenser at point A to a good ground; no other connection is necessary. There are five adjustments on the set: 1—The grid tuning coil, 2—the tickler coil, 3—the coupling between these coils, 4—the variable grid leak and 5—the variable condenser. The filament rheostat is not critical, so this is not regarded as an adjustment.

As the tickler coil and grid leak are in-

creased, a super-regenerative condition will be met with and the pitch of this note can be varied by the grid leak and should be adjusted until it is above the point of audibility, when only a slight hiss is heard in the phones. At this point a wonderfully sensitive condition exists for all classes of phone and C.W., and will tune in contrastingly clear as compared with any single-tube circuit you ever operated.

A given wave-length is tuned in by means of the variable condenser and grid circuit tuning coil; the tickler and grid leak are merely adjusted to conform to this condition. The resistance of the grid leak should be so arranged that it will give out a screeching noise as it is increased and follow through an intermediate series of pure notes until it passes out of audibility with a range of adjustment on either side.

The right polarity of the tickler coil in the plate circuit will have to be tried out by reversing the leads until the best results are obtained.

This is a standard circuit and may be used as such with an aerial and ground by reducing the tickler coil turns with the switch. With an aerial and ground the circuit can be used for transmission with a power tube and increased "B" voltage. All classes of "super" results may be obtained, which makes it an ideal vacation outfit.

There are several aerial combinations that work well; one of the most interesting is to connect the point G to the ground and touch the moistened finger to point A. For apartment houses, two combinations can be used: 1—Connect the point G to ground and the point A to some metal object or a small aerial in the room and 2—just connect the point A to the ground.

To operate the set in the car, connect the point G to the frame of the car through the steering wheel and the point A to the metal top or a small aerial in the top of the car.

When camping out, the best collector seems to be a wire from the point A to a ground connection about six or eight feet from the set; a short aerial may also be used.

If this is a "super," it is far superior to anything you have ever tried before in that line and it may be due to the fact that there are no large coils, condensers, or resistances to impede the real action of what a "super" might be, if given a chance.

### MECHANICAL THEORY

You have often turned the variable condenser of a standard regenerative set up to zero

(Continued on page 644)

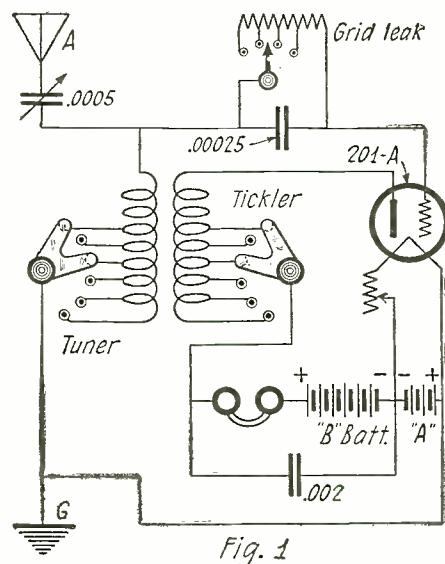

This is an Improved Form of Ultra Regenerator in Which a Super Regenerative Action is Obtained. If Properly Adjusted, the Variation Frequency is Super-Audible.

# Some Power Considerations In Radio Transmission

By CARL DREHER

IT IS well known that distance records in radio reception are made at night, and that the daylight range of a transmitting station is only a fraction of the night range. This statement holds for short waves, such as the wave-lengths under 600 meters used by the broadcasting stations. For long waves the case is somewhat different; it is found, for example, that in the eastern part of the United States the best hours for reception from Europe are in the morning, after daybreak, until early in the afternoon, and the commercial cir-

1,100 miles away, and sending on 373 meters. But this received voltage depends directly on the value of the current in the transmitting antenna, so that in order to sustain the strength of the received signal during the day at the night level, the *S. S. America* would have had to put 100 times as many amperes into her aerial as formerly. The power in the aerial equals the square of the antenna current multiplied by the antenna resistance. In order to get twice the antenna current, we must inject four times as much power; to triple the antenna current, nine times the power is required; in order to get an antenna current 100 times as strong, the set must be 10,000 times as powerful. From the commercial standpoint, this is, of course, a prohibitive requirement in the above case. The vessel could not carry a power plant large enough to supply the radio set and turn the propellers at the same time, nor would there be space for the erection of an aerial large enough to radiate the power if it were available.

Fundamentally radio transmission is a problem in amplification. In a radio telephone set we take the comparatively feeble energy of the human voice, which, unaided, can cover only a few hundred feet, and amplify it to power level by electrical means. This power is radiated in the form of an electric field and most of the energy is lost in space. The authors in the paper quoted above say, "In the radio telephone circuits which were operated in the experimental work the power in the sending antenna to that in the receiving antenna is in the ratio of roughly ten to the tenth power." That is, for distances of the order of several hundred miles, as an engineering proposition, we can expect to pick up only about one ten-billionth part of the energy we manage to put into the transmitting aerial. So, in order to get a workable signal, we must amplify once more and recoup, in a measure, the space losses. But there is an important difference between amplification at the transmitting end and at the receiving end. The latter is general amplification—it brings up not only the desired signal, but the interfering signals of both man and nature, including static. The former is individual amplification; it raises only the desired signal and tends to put it out of the reach of harm from other stations and atmospheric disturbances. On the other hand, transmitter amplification is a power proposition and involves great expense. Receiver amplification is comparatively inexpensive, so within the limits of its utility it is preferable. In practice the two methods supplement each other, with receiver amplification predominating where expense must be kept down and reliability of service is not essential, transmitter amplification taking its turn where continuity of service is a prime requisite. That is why amateurs do their trans-Oceanic and trans-Continental work with power on the order of that of an ordinary incandescent lamp, while commercial communication is carried on with something like 5,000 times this power for the same distance. But the amateurs get across only occasionally, and that mainly during the two most favorable months of the year, while the commercial interests transact their business all year round, though somewhat better in winter than in summer. No one has as yet been willing to invest so much money in the transmitter that the service would be absolutely unaffected by the increase in static during the summer.

The crystal receiver is about the only type

still in use which depends entirely upon the transmitter for its signal. Consequently its range is comparatively limited. In this connection it should be noted that a receiving set may amplify even without the use of tubes specifically known as amplifiers; a single bulb regenerative set has a much greater signal current in the plate circuit than is received from the aerial and delivered to the grid, regeneration being, in fact, the most useful, widely employed and economical form of radio frequency amplification.

The familiar Austin-Cohen transmission formula is

$$I_r = \frac{188 h_s h_r I_s}{R \lambda d}$$

where

$I_r$  = current in receiving antenna in amperes.

$h_s$  = height of transmitting antenna in meters.

$h_r$  = height of receiving antenna in meters.

$I_s$  = current in transmitting antenna in amperes.

$R$  = resistance of receiving antenna in ohms.

$\lambda$  = wave-lengths in meters.

$d$  = distance between stations in kilometers.

This is the simple formula for the ideal condition of no absorption in the space between the stations. Later the absorption factor which must be added when the formula is used for actual engineering calculations will be discussed. The simple formula, however, may be re-written for purposes of analysis as follows:

$$I_r = \frac{188}{\lambda d} (h_s I_s) \frac{(h_r)}{R}$$

This resolves the formula into three divisions, the first containing the constant 188 and the factors common to the two ends of the circuit, namely, the wave-length and the distance between the stations; the second

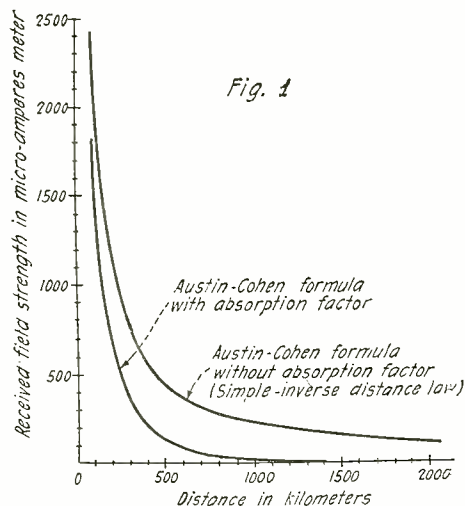

A Graph Illustrating the Effect of Absorption of Energy at Low Wave-Lengths.

cuits between Europe and the United States are worked at their fastest during this interval. But this is on 12,000 meters and up. When it comes to broadcast reception, however, a good many listeners cover their 1,000 or 2,000 miles after dark, although limited to a range of not over 100 miles in daylight. The telegraph amateurs, likewise, do all their brilliant relay work in the still hours of the night.

An interesting question arises: By how many times would these low-wave stations have to increase their power in order to cover, in the daytime, the distances which they frequently span at night, under favorable conditions? Lacking experimental data and insight into the energy relations of radio transmission, one's first tendency would be to estimate 20 times, perhaps, or something on that order. The correct figure is no less than 10,000 times! That is, 500 watt stations like WJZ or WEAJ, in order to be heard as far by day as by night, would have to increase their antenna power to the unheard-of value of 5,000 kilowatts!

This conclusion at first seems fantastic to the practical radio man, but it is the result of actual observations by engineers given in a recent paper.\* The *S. S. America*, west-bound, sent signals during the night, when she was about 72 hours out from the Atlantic coast and over 1,000 miles from the United States, and these were measured for intensity by the engineers at Elberon, N. J. During the night the field strength at Elberon, expressed in millionths of a volt per meter or receiving antenna height, was over 200 units. At sunrise this fell to a value of two units, and remained at this point during the day. In other words, the receiving aerial at Elberon received 100 times as much voltage from the *America* at night as in the daytime, when the vessel was about

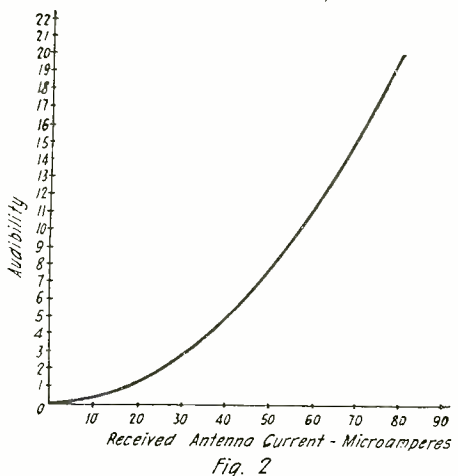

A Curve Showing How the Response of a Detector Varies with the Received Current.

division referring to the transmitting station, and the third to the receiving station. The received current is greater the shorter the distance between the stations, of course, and goes down inversely as the distance increases. This must be so because the radiated energy must spread over the circle where radius is "d" and the circumference of this circle is  $2\pi d$ . Also, we see that for the condition of no absorption the shorter the wave-length, the better, as far as radiation is concerned.

(Continued on page 616)

\*See H. W. Nichols and Lloyd Espenschied, "Radio Extension of the Telephone System to Ships at Sea," *Proceedings of the Institute of Radio Engineers*, Vol. 11, No. 3, June, 1923.



# Everyday Observations of the Beat Phenomenon

By W. PALMER POWERS

OF STEVENS INSTITUTE OF TECHNOLOGY

**P**ROBABLY one of the most important principles employed in radio today is the principle of beat production. The designer is always concerned about the production of beats. He is, as a rule, either attempting to produce them or eliminate them. Certain radio devices depend upon the production of beats for satisfactory operation, while the production of beats is fatal to others. The production of beats has been widely used in radio and for this reason many have the impression that the principle has no other field of application. It is the purpose of this article to call the readers' attention to a few of the everyday examples of the production of beats which are not associated with radio, and to stimulate, if possible, an interest in this basic principle which will result in its more general use.

### THE CONDITIONS REQUIRED FOR BEAT PRODUCTION.

Beats are produced when two regular periodic impulses exist simultaneously, providing the periods of the impulses are slightly different. (The word *impulse* is used here to

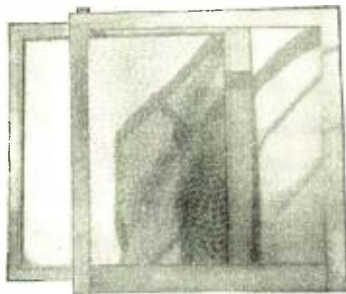

Fig. 4. Beats Produced by Two Window Screens Placed in the Same Line of Sight.

indicate any sort of disturbance.) To those who are familiar with radio, the idea is easily understood. For example, a 3,000,000-cycle wave associated with a 2,999,000-cycle wave will produce a beat frequency of 1,000. If these component waves are sine waves, the variation in the resulting beat impulse will be of the same form. If the component impulses are not simple waves, the resultant will, of course, be irregular in contour. However, as long as the component impulses are regular and periodic (as long as they repeat regularly), the resultant will be some form of beating impulse. The frequency of the resultant is always equal to the difference of the component frequencies. In electrical work it is quite usual to employ smooth waves and, as a consequence, the resultant wave is also smooth. In other fields it is not convenient to use smooth waves, but it is possible to employ some sort of regular recurring sequence of events and thus make possible the production of beats.

### THE DETECTION OF BEATS

We are able to detect beats in sound, providing the components are distributed with

Fig. 3. Visible Beats Produced by Two Picket Fences in the Same Line of Sight.

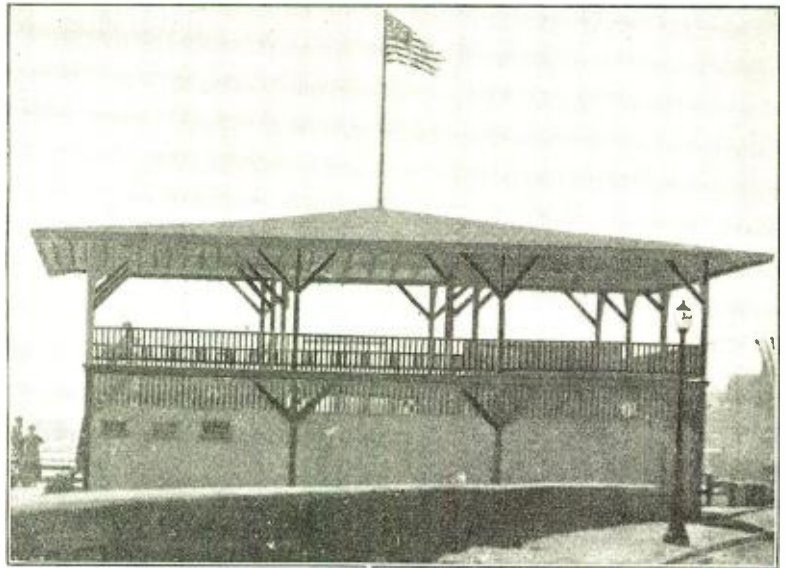

respect to *time*. For example, two strings vibrate with slightly different frequencies; the result is an audible beating effect.

We are able to detect beats visually if the components are distributed with respect to *space*. For example, lay off a few marks regularly spaced on a piece of paper and repeat the process on the same paper using a slightly different spacing. The result will show regular beats which, of course, are visible. (See Figure 1.)

We are able to detect beats by our sense of feeling, if the components are distributed with respect to *time* and are capable of producing appreciable motion. For example, in a certain piece of machinery there may exist two independent vibrations due to the natural period of certain parts of the structure. These two vibrations result in a slow and regular beating of the machine as a whole. By placing the hand on the frame of the machine, this effect is readily detected.

### SOME FAMILIAR EXAMPLES OF SOUND BEATS

Beats resulting when two tuning forks of slightly different pitch are operated simultaneously.

Beats resulting when two strings of a musical instrument are slightly out of tune.

Beats resulting when two electric currents of slightly different frequencies are applied simultaneously to the magnet of a telephone receiver.

Beats resulting from the interaction of harmonics of a musical note.

One could extend this list to a considerable length with very little effort, and the analysis of each case would doubtless lead to some interesting results. The results of these investigations will possess one feature in common. In each case there will be found two or more sound disturbances, each having a regular period.

### SOME EXAMPLES OF VISUAL BEATS

Beats resulting from the existence of two series of regularly spaced marks, each series having a slightly different spacing. (See Fig. 1.)

Beats resulting when two picket fences are seen in the same line of sight. (One being visible through the other.) (See Fig. 3.)

Beats resulting when two window screens are placed in the same line of sight. (See Figs. 4 and 5.)

Beats resulting when observing the spokes of a wheel through the spokes of another, as for example, the wheels of a passing automobile.



Fig. 5. Visible Beats Produced by Two Window Screens as Seen from an Angle.

Beats resulting when looking at an ordinary electric fan through the blades of another, both fans, of course, being in motion.

Beats resulting in motion pictures of automobile wheels, airplane propellers, etc., due to the fact that the time between exposures is not far from the time between similar positions of the spokes or propeller blades.

The mottled effects in some of our most beautiful fabrics are frequently due to the existence of two layers. These peculiar and changeable effects are the results of two more or less regular fabrics constantly changing in relative position.

Beats are visible in the natural folds of a lace curtain due to the overlapping of two or more layers of fabric.

An ordinary electric fan, when in motion, may show some peculiar effects if viewed under an electric lamp. If the lamp is operating an alternating current, the light

(Continued on page 622)



Beats Resulting from the Existence of Two Series of Regularly Spaced Marks, Each Series Having a Slightly Different Spacing.

Fig. 1

# The Amateur Traffic Problem

By HOWARD S. PYLE, A. M. I. R. E.

Ass't U. S. Radio Inspector, Eighth Radio District

**A** VERY, very serious mistake is occurring nightly in the amateur world—a mistake that is worthy of grave consideration. In the opinion of the writer it is the greatest single reason for the controversy between the broadcast listener and the amateur. This is the method in which actual amateur message traffic is being handled. The broadcast listener asserts that the amateur is not performing any useful work. The amateur stoutly maintains the opposite, and points with justifiable pride to the service of amateurs during the period of late hostilities. This, however, only brings forth a grudging assent from the opposite faction who immediately counters with, "Well, what are you accomplishing NOW?" And then the particular amateur under fire swells up with pride and cites as an example of their peace time activities, the free relaying of public messages to practically any part of the United States. Facing the facts, this is a joke! Let us see why.

Accepting a message from a sender imposes a real obligation on the amateur to put it through. The operator with whom the original message is filed, sees as his one and only object the moving of that message to some other station at the earliest possible moment. Now here is where the joker enters. It is apparently UNIMPORTANT to WHAT particular station it is forwarded as long as it leaves the station of origin, thus relieving this latter of responsibility. A message originating in Columbus, Ohio, for instance, destined to St. Louis, will in all probability go from Columbus to Lansing, Michigan, because Lansing happens to answer a "CQ west" transmitted by the Columbus station. Lansing in turn probably gives it to Indianapolis who further relays it to Cincinnati, thence to Louisville and finally St. Louis, provided it has not become lost enroute, as many do. The obvious method would have been for Columbus to get that message to Cincinnati, then Louisville if necessary and finally St. Louis, a much more logical route, eliminating two absolutely unnecessary relays. It would be much more preferable to delay the message an hour at the station of origin, to enable pushing it through via the proper route, than to cause two or three days' delay by routing it by the first described "zig-zag" route.

## LOOK AT THE MAP FOR SHORTEST ROUTE

The possible explanation for poor routing of messages appears to the writer to be due to the failure of amateur operators to determine the location of a station before they give him traffic. Coming into the air with his own transmitter at station 8DAG, in January of last year, the writer was given traffic by numerous stations for relay without a "QRA" and at a time when the writer's address had not yet appeared in any call book. The station was "somewhere in the eighth district," which to them seemed to be sufficient QRA. Innumerable times messages have been offered by second and third district stations for relay BACK into THEIR OWN DISTRICTS, they, apparently, "assuming" 8DAG to be on the eastern border of the eighth district, when in reality it was on the extreme western line. The prize came one evening when a message originating in Toronto, Canada, destined for Boston, Mass., was offered the writer, then in Cincinnati, Ohio! Trace it on the map!

Passing on to the next subject in connec-

tion with amateur traffic handling methods, suppose we consider the time element. Immediately a message (the word being generally accepted as symbolic of quick communication of intelligence) takes a length of time equal to, or greater than, the time consumed in transmitting such intelligence through the usual postal routes, it defeats its purpose. But when it requires, in an overwhelming majority of cases, a period of time far in excess of that consumed in forwarding communication by the old "pony express" or stage-coach route—then it becomes a laughable attempt at accomplishment. And the politely shielded smile which meets the boaster of "free public messages via amateur radio" bears this out. The time element MUST be reduced! Part of the fault—perhaps the largest part—is due to the faulty routings which we have already discussed.

**T**HE author of this most interesting article is an old-timer who, knowing the problems of amateur Radio, is well qualified to suggest remedies for the present conditions, and what should be done for the good of the art. He has owned and operated amateur stations:

"MA" (Prior to 1912 law) Paterson, N. J., 7HP, 7NG, 7FZ, 7OE. 8DAG at various periods since 1909. He has seen service in practically all parts of the world as wireless operator, afloat and ashore, and has instructed in radio schools, both military and commercial. He had five years of radio operation, installation and maintenance in the U. S. Navy, including a year in Naval Overseas Transport Service during the late war. He served as Supervisor of Traffic at a high power naval center station, was operator of Alaskan high power circuits, Chief Radio Engineer in a prominent manufacturing company and is now Assistant U. S. Radio Inspector for the eighth radio district, with headquarters at Detroit, Mich. He has held all grades of U. S. Radio Licenses including extra first grade commercial.

Another large share of the blame rests on the shoulders of the various operators through whose stations the message passes. Irresponsibility is the proper name for it. It is said that no enterprise will receive proper attention nor render an adequate service that does not bring financial gain. Amateur radio must be the exception; in fact it should be almost a RELIGION with the amateur station owner and operator to uphold the game by demonstrating the reliability of service that can be expected from amateur radio. If an amateur does not care to assume the responsibility incident to moving message traffic with despatch, which sometimes means late hours through heavy interference and bad atmospheric conditions, he has ABSOLUTELY NO RIGHT to accept traffic offered him in good faith by some conscientious station working to keep the game on its proper level!

Doubtless the writer will be severely criticized for these bald statements, and

records such as the fast transmission to Hawaii from Connecticut with only one relay in Minnesota, be quoted as indicative of proper routing and fast communication. But, such records are so exceptional, compared with the average methods of communication by amateur radio, that they become the subject of leading articles in the radio journals, with photos of the stations and owners! They are even considered unusual enough to warrant space in the daily press! Undoubtedly a marvelous accomplishment, but to make amateur radio accomplish a REAL purpose, these records must become the common-place and poor routing and time be the exceptions. The writer does not necessarily mean that long jumps and split-second time as in the Hawaiian relay become the rule, but merely that good, common, horse-sense should result in a message filed in Philadelphia in the evening, destined for Chicago, reaching there by an almost straight line, employing but two or three relays, in a few hours from the time of filing. This can be done between average stations under prevailing conditions.

## UNIMPORTANT MESSAGES CAUSE QRM

It is perhaps foolish to dwell on the utter foolishness of the majority of matter transmitted as messages. However, as we are well started on our subject, let us at least generalize on this point. Not so long ago the air was badly "spattered" with, "Greetings by radio." This became such a common form of message that often a station would call another, give him such a message and say, "Rest all same body, hr nr 2 to —sig—" etc., until he had run off a string of ten or twelve. Utter rot, and the stations in time came to realize it and voluntarily began to refuse to handle such messages when offered. In a short time, they very naturally became practically extinct.

During the last winter and spring season, a new "nigger in the wood-pile" appeared in the form of messages reading, "Thanks for card. Will QSL," or similar "intelligence." These appeared to an even greater extent than the "Greetings by Radio" type had formerly done, and, towards the close of the season, efforts were well under way to stamp out this newer menace by the same system of refusal of those offered. They are pretty well in the minority now, but what next? Why not show some discrimination in the acceptance of traffic that is meaningless? This discrimination should be directed towards the sender, for once we have accepted a message for transmission it is our moral obligation to see it on its proper way. The fault in cluttering the air with useless messages lies in the amateurs themselves, and in their organizations. There has been, and still is—in fact it is on the increase each month—a mad scramble for large message totals. This is encouraged by radio publications and a good natured rivalry instituted among the better stations to see who can turn in the greatest monthly total of messages handled. This is WRONG, positively and absolutely wrong! It is spoiling the game and causing dissatisfaction between the various factions second only to improper routings and consumed time in transmission! The object should be—not how MANY messages can be handled—for we already know the physical limitations of amateur radio transmission—but what

(Continued on page 606)

# Silent Code Will Reduce Interference

By S. R. WINTERS

**T**HE invasion of a heretofore unutilized band of frequencies for the transmission of radio telegraph signals is contemplated by the Signal Corps of the War Department in the application of the recently proposed modification of the Morse telegraph alphabet. The resumption of activities of the Signal Corps Radio Research Laboratory, located at the Bureau of Standards, with the transferral of Lieutenant Colonel J. O. Mauborgne from Chicago to Washington in charge, signifies the earnestness with which this branch of the Federal government is attempting to apply the new telegraph code system.

"This plan proposes to enter the unused infra-audio range, which would not only add a most useful band of frequencies to those now used, but would give a band below the range of the human ear," asserts Major General George O. Squier, Chief Signal Officer of the United States Army, who is shown in the exclusive photograph, reproduced with this article, operating the machine for transmitting the modified Morse telegraph alphabet. For the reason that this method of signalling is capable of utilizing a band of frequencies not audible to the human ears, it has been picturesquely referred to as the "silent code."

The Chief Signal Officer of the Army recites a patent fact when he states that "the radio engineer has utilized and made his own all of the audio-frequency range and at least several octaves of the radio-frequency range, and has devised apparatus for the amplification and rectification of both of these ranges, audio and radio." If additional bands of frequencies are opened up as avenues of travel for radio-telegraph signals, so to speak, the existing interference experienced in the reception of music and speech by means of radio telephone receiving sets would be appreciably obviated. "This method of eliminating interference is the most effective," avers Major General Squier.

The kind of interference just referred to is that due to the congestion of the atmosphere with the offerings of song and story by the approximately 550 broadcasting stations operating on a limited band of wavelengths ranging from 200 to 600 meters. Then, too, there is the major confusion, which this proposed code system would obviate, namely, the signals transmitted from arc and spark transmitters of the radio telegraph stations. Aside from these forms of artificial interference, man-made as it were, there are the natural atmospheric disturbances, in other words, "static."

The sending of the telegraph alphabet by varying the intensity of the three elemental signals instead of the transmission dots, dashes and spaces according to different time intervals, would probably aid in the suppression of atmospheric disturbances. Certainly, the new code system operating on modulating frequencies of a very low order, would encounter "static." The latter, also, is believed to be impulses of a low frequency—varying from 200 to 300 cycles a second. The proponents of the modified Morse telegraph code express the belief that instrumentalities can be devised for distinguishing between atmospheric disturbances and the low modulating frequencies on which the orderly signals are borne.

The ability to differentiate between atmospheric disturbances and the low modulating frequencies employed by the new Signal Corps alphabet is indicated by experiments. It is observed that a modulating frequency as low as 10 cycles a second—a



Major General George O. Squier Seated Before His Machine Which is a Portion of a New System for the Transmission of Signals at Very Low Frequencies. Instead of a Make-and-Break System the Signal Intensity is Varied.

very high frequency for ocean cable practice—corresponds to 75 words a minute. This exceeds that of any form of sound reception. A modulating frequency of 60 cycles per second, the normal power frequency, is equivalent to a rate of transmission of 450 words a minute, allowing five letters to the word.

If, however, this rate of transmission is incompatible with the traffic conditions, it is only necessary in the sending of the Signal Corps code to make the same perforations in the transmitting tape correspond to a suitable even multiple of a semi-cycle in order to slow up the speed to any desired value. To illustrate, by making each of the signalling units correspond to six complete cycles of current instead of one semi-cycle, the rate of transmitting this telegraph alphabet is reduced to  $37\frac{1}{2}$  words a minute, a speed corresponding to commercial signalling. Wave trains are used as the signalling elements in the Signal Corps system. The ratio of the lowest frequencies employed in radio telephony to the modulating frequencies considered in the modified Morse alphabet is of the order of thousands.

The new system of signalling as such, by means of which dots, dashes and spaces are sent by varying their intensities, has already been fully discussed in the pages of this magazine. However, its application as contemplated by the activities of the Radio Research Laboratory of the Signal Corps, at the Bureau of Standards, advances this radical method of signalling beyond the stage of mere theory. The use of the new alphabet as a method of signalling in the event of future wars, doubtless prompts the Signal Corps to lend its present energies toward practical application.

Its significance in times of peace, however, contemplates a conservation of the avenues of communication, familiarly known as ether lanes. The radio telegraph and radio telephone are both clamoring for room, comparable to a "pack-and-jammer" trolley car in which the occupants hang onto straps with bull-dog tenacity. Figuratively,

the crowded ether lanes are in this condition today. The prevailing confusion is even cumulative! Now, according to the invention of C. Francis Jenkins of Washington, D. C., the broadcasting of photographs through space is not a remote accomplishment. Still but another step, recently demonstrated in his laboratory, motion pictures may be eventually dispersed in a manner not greatly dissimilar to the present method of broadcasting music and speech.

Little wonder is it then, that Major General George O. Squier in advocating the application of the modified Morse alphabet vigorously emphasizes the exigency in these words, "The conservation of the ether lanes is suddenly rising to international importance. In addition, the daily growing uses of radio for the solution of auxiliary problems such as range finding, navigation, beacons, etc., further serve to complicate the problem which will require and demand additional ether channels to serve the public of the near future."

## STATE COLLEGE TO TEACH RADIO BY CORRESPONDENCE

Correspondence courses in radio reception and transmission are now being offered by the engineering extension department of the Pennsylvania State College. According to N. C. Miller, head of the department, this new bit of extension service has been instituted in response to a large number of requests that have been received.

The course is divided into two parts, each with its own text and assignment pamphlets. The first part establishes principles, and suffices for the ordinary student. It takes up common electrical phenomena, radio circuits, the vacuum tube, amplification, sources of power, transmission circuits, and applications of radio.

The second part is a continuation for those desiring advanced instruction and goes more  
(Continued on page 623)

# Radio In the Professional Field

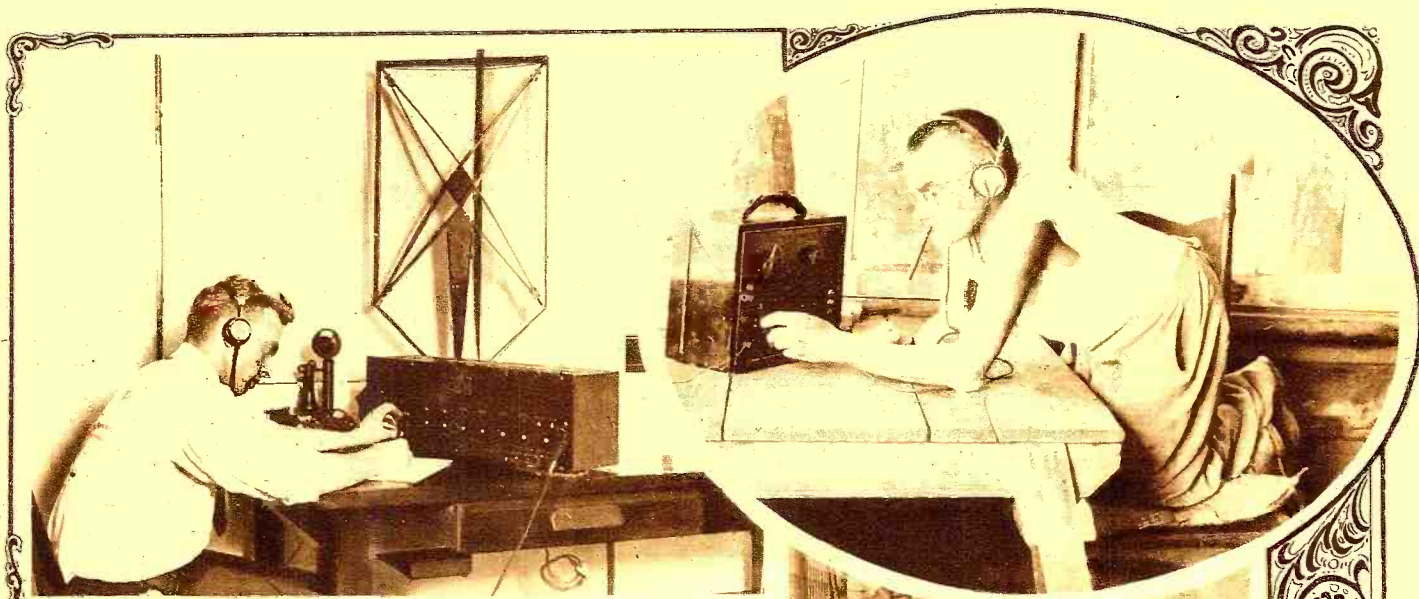

Above: The Super-Heterodyne Receiver Used at Station WCAP at Washington, D. C. Seven "N" Tubes Are Employed in This Set, Three of Which Are for Radio Frequency Amplification, One as Oscillator, Two as Detectors and One as an Audio Frequency Amplifier. Note the Loop Aerial Behind the Cabinet. ©Kadel & Herbert.

Above Right: Dr. C. P. Steinmetz, Chief Consulting Engineer of the General Electric Company, is an Enthusiastic Radio Fan. He is Here Seen Adjusting the Small Set Which He Uses at His Summer Camp on the Mohawk River, near Schenectady. He Gets Most of the Larger Stations with His Set, But His Favorite Naturally is WGY, the General Electric Company Station at Schenectady.

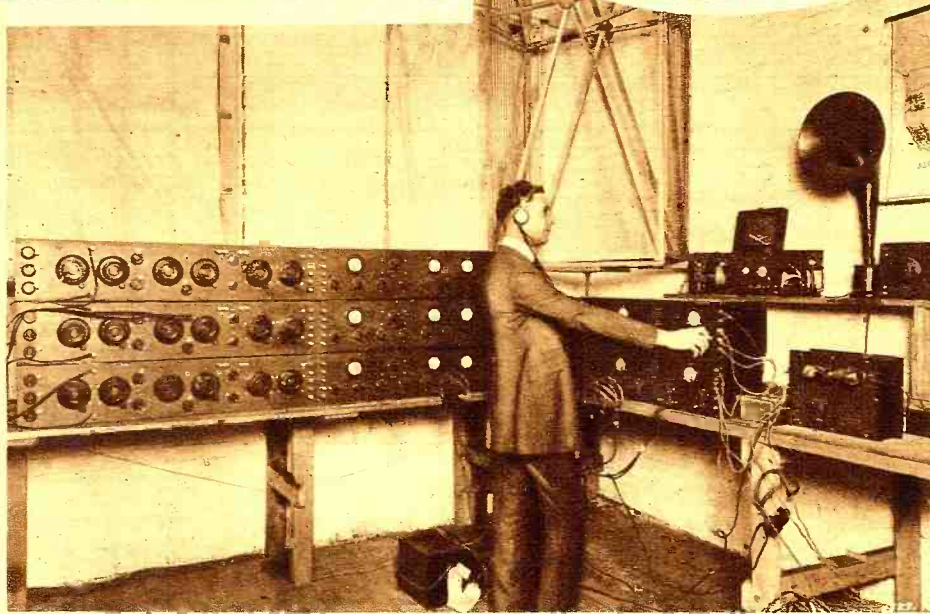

Mr. Golden, in the Laboratory of the Experimenters' Information Service, New York City, Doing Quite a Stunt in the Way of Multi-plex Reception. He is Receiving Five Distant Stations on Five Separate Super-Heterodyne Receivers at the Same Time. This Well Proves the Selectivity and Ease of Control Possible with These Sets. Practically No Interference Was Noticeable During the Experiments.

## Amateur Radio In the Orient

By ROY A. ANDERSON

THE thought of the average amateur has been taken up with his own achievements, and to a large extent he has ignored the foreign radio bug; in point of fact it can be said that he has hardly even stopped to think that there might even be such a thing. There is though, and some of those in Europe have recently brought themselves into the limelight.

There are only a few others, perhaps, but they're there. Who? The Oriental fan, novice, amateur or bug, whichever name you think suits him best.

A recent trip to the Orient enabled me to get the idea that they were there. Limited time, though, rendered it practically impossible to see any amateurs personally.

In Kobe, Japan, the first thing that struck my eye was a sign in English proclaiming a branch of a Tokio radio store.

In Hong Kong I was fortunate enough to talk with a radio man. While legislation there is far from being as lenient as in America, it is better than in China or Japan (remembering that Hong Kong is an English colony).

Rather than tell my uninteresting experiences in rounding out little or no news I will give some extracts from some of the oriental papers, relating incidents which happened while I was on the other side.

A Shanghai paper contained the following item:

"At a meeting of the Shanghai Amateur

Radio Society at the National Y. M. C. A., Tuesday, Professor C. H. Robertson, the vice-president, said there were several organizations in Shanghai among foreigners and Chinese, and suggestions had been made for a federation of all of them, in order to put amateur radio effort on an inclusive footing."

From this item one can readily see that not only the foreigners—Americans, English, etc.—but the Chinese themselves are interested in the game. The very fact that organizations have already been formed shows that it has been there, and even though legislation is unfavorable to the large majority, there are those who mean to stick

(Continued on page 620)

## Carl W. Klenk's Station 9AAU

**S**TATION 9AAU employs two transmitters, No. 1 for voice only and No. 2 for C.W. only.

Both transmitters receive their plate supply from a 1,000-volt Emerson generator, employing as a filter system two  $1\frac{1}{2}$ -henry chokes and 1 mfd. condensers. This produces a pure D.C. note for transmitter No. 2 and the modulation is as nearly perfect as possible on transmitter No. 1. Positively no generator hum is noticeable.

Transmitter No. 1 uses two 50-watt tubes in the Hartley circuit with the Heising system of modulation. The plate voltage in this case is cut down to 850 volts by means of a field regulator. On 200 meters, this transmitter radiates 3.8 thermocouple amperes.

Transmitter No. 2 uses three 50-watt tubes in parallel using the famous 1DH circuit, 1,000 volts on the plates. On 200 meters this set radiates from 5.0 to 5.5 thermocouple amperes.

The antenna is of the ordinary flat top "T" type, with an 8" cage lead-in directly to the set. The masts are 55' high and 55' apart. The antenna is composed of eight No. 14 wires on a 14' spreader, the actual length being 50' and actual height from earth 50'.

A counterpoise somewhat different from the conventional type is employed, consisting of 24 No. 14 rubber covered wires, 60' long, lying directly on the earth.

According to Hoyle, a counterpoise should give best results when suspended directly under the antenna and suspended 10' to 15' above the earth. We tried this type and got fairly good results, but in an endeavor to eliminate the unsightly appearance by having a lot of wires suspended over the greater part of a small back yard, we placed eight insulated wires directly on the earth and were surprised at the result. We increased the number of wires until we reached 24 and found that this not only did away with the unsightly appearance of so many wires but actually increased the efficiency of the transmitters.

In addition to this we employ a tuned ground composed of four 2" pipes driven 8' into the earth.

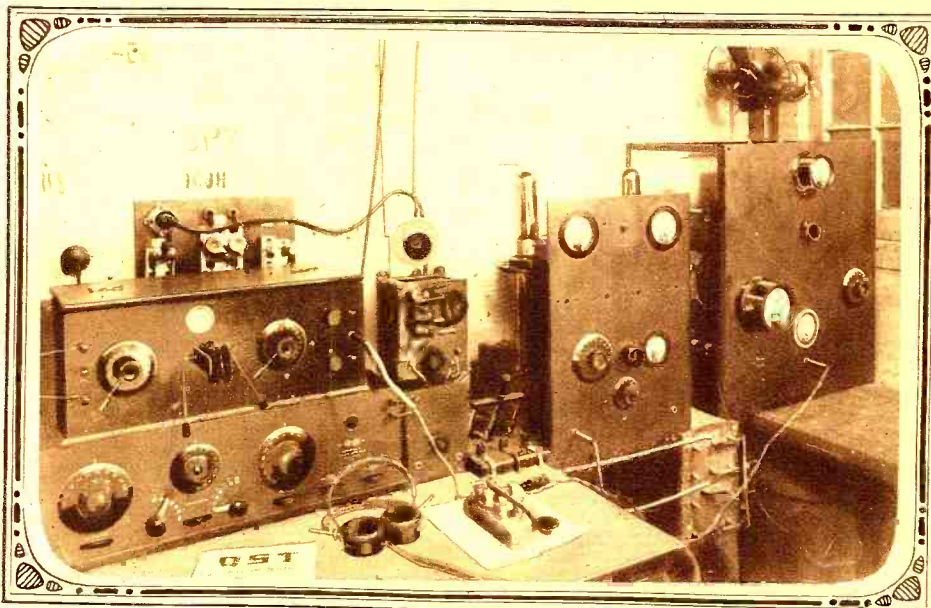

A Well Designed Station Which Has Been Heard In New Zealand, Canada and the Azores. Two Separate Transmitters Are Used For C. W. and Phone.

At this time the wires of the counterpoise are completely covered by grass and cannot be seen, doing away entirely with the unsightliness and also permits children to play in the yard without interfering in any way with the wires.

Two receivers are used: a Grebe CR-8 and a home-made three-circuit spider-web receiver.

This equipment is housed in a small 8'x8' shack in the rear of a 35'x70' back yard.

9AAU has been in existence for about 2½ years a 1-K.W. spark being first employed and replaced later by a 20-watt C.W. set.

The new transmitters were installed in the early part of this year. Nothing of any great importance was attempted prior to this spring. Since March 15 9AAU has been quite active and since the completion of the above described counterpoise, about June 1, 9AAU has been heard nightly and consistently.

9AAU was heard in May and June by F. D. Bell of Waihamo, Otego, New Zealand and in the Azores in July by the Rev. A. F. Drake of the First Presbyterian Church of Orange, Texas. This station has also been heard in Hawaii, Alaska, every district in Canada, Canal Zone, Panama, Cuba and in every State in the U. S.

Every district including Canada has been worked during the summer.

The best heard reports during the hot weather, July and August were from 7SE, 7PZ, 6AO, 2PF, 1BRQ, 1BHJ, 1BOA, 2DAB, New Zealand and the Azores, and many others.

The equipment, including receivers and transmitters, except of course the Grebe CR-8, were built by the operator who is 15 years old.

CARL W. KLENK, "AR" Op.  
3148 Halliday Ave.  
St. Louis Mo.

## J. R. Watson's Station 3JV

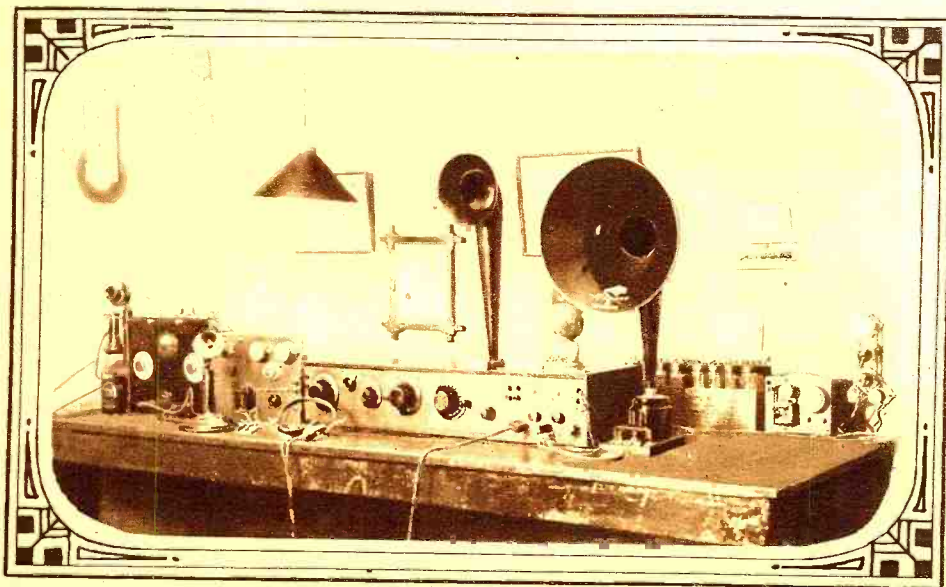

**T**HE transmitter at 3JV, which is shown at the extreme left is a ten-watter, employing the Stanley reversed feed-back circuit. The filter system consists of 14 jars with ammonium phosphate solution 2-mfd condenser, and a 5-mh. choke. Absorption modulation is used for local phone work. Radiation obtained is 1.7 hot-wire amperes on straight C.W. and 1.2 amperes on phone.

This Well Laid Out Station Comprises a 10-Watt Transmitter and Standard Regenerative Receiver With Amplifier

The aerial is a five-wire cage, 80' long and 50' high. It is tapped in the center and a 6" cage leads directly to the instruments. An eight-wire fan counterpoise is located 20' below.

A three-circuit variometer receiver, with two steps of audio frequency amplification is used. Amateurs in every district but the sixth have been copied through the Magnavox.

J. R. WATSON.

# The Great Radio Message From Mars

By ELLIS PARKER BUTLER

Author of "Pigs Is Pigs"



He Had No Success Whatever Crystallizing the Limburger Cheese After It Had Been Boiled. It Would Not Form Itself Into Crystals. It Formed Ropes and Slabs of Limburger Linoleum and Soup, But it Would Not Form Crystals. It Formed Odors So Strong that the Roof Flopped Up and Down and the Foundations of the House Palpitated, But it Would Not Crystallize.

TO receive a message from Mars has long been the hope of many of our eminent scientists, for it is known that the planet has an atmosphere capable of supporting human life, although it is believed—because the weight of a given mass at Mar's surface is only three-eighths of the weight of the same mass at the surface of the earth—the men of Mars must be very much larger than the men on our earth. Certainly they would be far larger than Mr. Ithuriel Duff, of 564 Sausage Street, Hoboken, N. J., for he is what one might justly call a mere shrimp. And yet, small as Mr. Duff is, his is the honor—as he himself admits—of having received the first message by radio from Mars.

There is no doubt in my mind that Mr. Duff did receive such a message, and on a crystal set, for the facts were given me by an official of a state institution. This official was a large muscular man and he wore a uniform with a cap to match, and I always believe anything a man in a uniform tells me. This official's name is Casey—Michael Francis Xavier Casey—but he is called Mike for short. By his intimate friends he is addressed as Bum-nose Mike, but this is only because at one time he was a prize-fighter and one of his opponents, as Mr. Casey himself says, gave him a "biff on the smeller." But that has nothing to do with the amazing discovery of Mr. Duff.

I found Mr. Casey, when I went to interview Mr. Duff on behalf of the Upper Flushing Scientific and Annual Clambake Association, most agreeable. His uniform was of a greenish brown cotton stuff, and

on his cap and the flap of the collar of his coat was a number—number 47, in fact—in what at first seemed to me gold numerals. I later decided they were not gold but only brass, either highly polished or gold-plated.

"Mr. Casey, sir," I said, "I have come to interview that distinguished radio scientist, Professor Ithuriel Duff, on behalf of the Upper Flushing Scientific and Annual Clambake Association. While we have read rather complete accounts of Professor Duff's discoveries, and several papers on them have been written by our members, and read at our meetings, a dispute has arisen among us, and I have been delegated to interview Professor Duff and get the true facts.

"It seems, Mr. Casey, sir," I continued, "that some doubt has arisen whether Professor Duff actually heard from Mars itself. As you know, sir, the eccentricity of the orbit of Mars is very much greater than that of the orbit of the Earth, being 0.093 as compared with 0.017, less the usual 2 per cent off for cash in ten days, and this has led some doubting minds to hold that—the refraction of the ether wave being in inverse ratio to the normal vote for Bryan on Tuesdays not falling on Sunday—Professor Duff really received a message from one of the moons of Mars, and not from Mars itself.

"You are undoubtedly aware, Mr. Casey, sir," I said, "that the two moons of Mars were discovered by Professor Asaph Hall in Washington in 1877, conformably to the prediction of Kepler, and realizing the fan-

cies of Swift and Voltaire."

"Is that the Swift that has the big slaughter house in Chicago?" asked Mr. Casey.

"No, Mr. Casey, sir," I said.

"Then I don't know him," said Mr. Casey.

"Do you know Mr. Swift of Chicago?" I asked politely.

"No," said Mr. Casey, "I don't know him neither. I don't know no Swifts, and I don't want to know no Swifts. I don't want to know nobody; I know too many folk already."

"But you no doubt do know, Mr. Casey, sir," I said, "that the inner of the two moons of Mars, Phobos, revolves in less than eight hours, so that to an observer on the planet it rises in the west and sets in the east; while the outer moon of Mars, Daimos, revolve in thirty hours, so that it appears nearly stationary for a long time."

"Have ye got a chew of tobacco in yer pants?" asked Mr. Casey.

"No," I said, "but you can easily see that this fact indicates that radio waves coming from the moon Daimos would be audible for a longer time than those from Mars or from the moon Phobos, because the moon Daimos moves slowly, while Mars revolves—"

"I'd give me left ear for a chew of tobacco, that I would!" said Mr. Casey. "P's'nally I like the soft kind. The dry kind chews longer, but the soft kinds spits freer. I was always a great one for spittin'! I says to me wife, many's the time, 'What fun does a man get out of chewin' if he don't spit?' Now, when it comes t' cigars—

(Continued on page 596.)

rheostat on the positive side and a 201-A as the audio-frequency tube with a 10-ohm rheostat on the negative side will make as sensitive a set as can well be used to advantage under average conditions. These sets are noted for their quietness of operation, simplicity of construction and operation and excellent selectivity, and will when atmospheric conditions permit, allow a somewhat greater range to be covered than can be accomplished with the standard regenerative set.

In building such a set you should always be ready to compare the results directly with the standard regenerative set on the four vital points of signal strength, selectivity, distance and consistency and never consider your work through until the new set has proven superior on all points.

The present day development of radio frequency amplification at amateur wave-lengths has not progressed far enough to be called at all successful or desirable after the first stage is passed. Besides the losses in the stabilizers we must either use transformer coupling between the stages or else tune each stage separately, neither of which is practical or desirable in a set for amateur communication, although there is room for much experimenting here, but the experimenter is cautioned to be sure of his ground before any big claims are made for more than one stage of radio frequency amplification at amateur wave-lengths.

The reflex circuits belong to the broadcast listeners and even then should be considered only in connection with portable sets or where it would be impossible to use a radio and audio frequency of the same number of stages with separate tubes.

The same line of thought should be applied to the rest of the "new" circuits that are making their appearance almost daily, for as a rule their value is nil.

The recognized acme of perfection in the matter of short-wave reception is the Super-Heterodyne. Unfortunately this receiver is too complicated and expensive and requires too much skill to operate for the great majority of amateurs, and like all other sensitive receivers its long distance ability depends almost entirely upon atmospheric conditions after the operator has learned to operate it, and the faintest static heard in a regenerative receiver will be uncomfortably loud in the Super-Heterodyne. However, for special test purposes or for use when static is nil, the Super-Heterodyne is recommended to the advanced amateur.

The only circuit of merit for amateur reception that has appeared in the last two or three years is the Super-Regenerator, yet for several reasons this most wonderful contribution of Mr. Armstrong's has not met with general favor, especially in cities where receiving sets are thick and power line disturbances are to be contended with

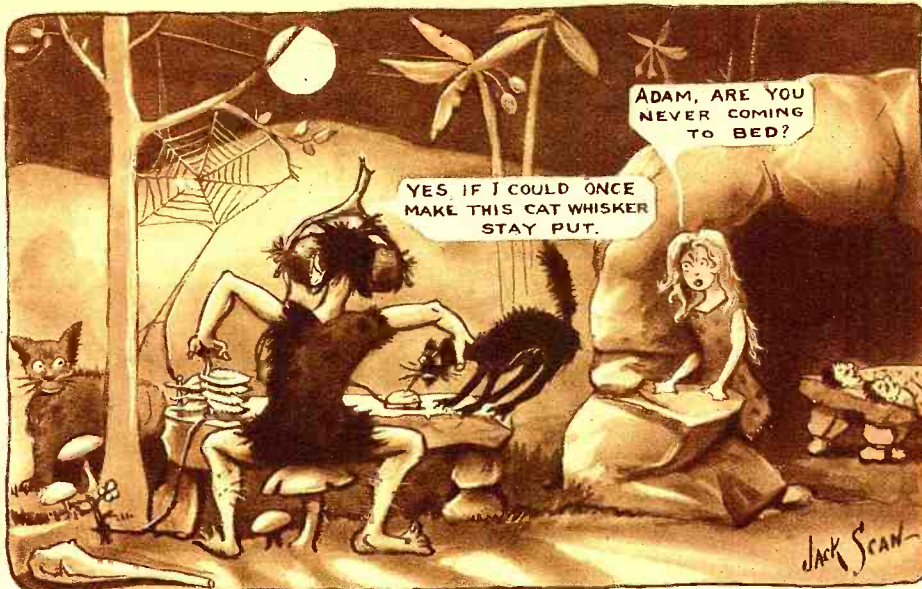

The First Amateur Had His Troubles, and DX Work Was Almost Impossible on Account of Local QRM.

and the Super-Regenerative might be termed the set for the country or small village where one is not liable to be disturbed by local electrical power or to disturb his next door neighbor's receiving. In such a role the Super-Regenerator will be a very valuable addition to a regenerative set and should be considered first of all in preference to any form of radio frequency or other forms of communication.

Like all other extremely sensitive devices, it can be used only to advantage when atmospheric disturbances are low. Unlike radio frequency amplification, its efficiency increases greatly as the wave-length is decreased, which makes it especially suited to the reception of short wave-lengths. There are several forms of super regenerative circuits, all of which will give a "Super" effect to a more or less extent, some of which give very loud signals with lots of noises while others give a weaker signal with much less noise and much greater distance. For all practical amateur needs the single tube method, aided if desired by one stage of audio frequency amplification, is by far the best. Nothing better has yet been found to take the place of the oscillators than the large honeycomb type of coil shunted by condensers, and for amateur purposes the UV-201A tube working at a plate potential of between 45 and 90 volts is very desirable and should be used wherever possible.

The super-regenerator is especially suited to and recommended for distant daylight re-

ception of amateur C.W. or phone signals, but it must not in any way be considered as taking the place of a regenerative set, but simply as a very valuable attachment thereto, to be used only when conditions permit or warrant.

No circuit will decrease static to any considerable extent, in the common meaning of the word. Any circuit that actually decreases static also decreases signal strength, and the amateur is especially cautioned to step shy of all circuits that claim to reduce it. It is impossible to make a set cover the same or greater distance than can be covered by an ordinary regenerative set and decrease static at the same time.

The problem of radio today is not to decrease static, but to secure a greater ratio of signal strength to static, and some headway has been made in this respect on the long-wave high power stations where abundance of signal strength is available, but for amateur purposes they may be considered nil.

Directional aerials will give a greater ratio of signal strength to static provided the source of static is not in the same direction. The beverage wire is perhaps the best of these, although unfortunately many have not the room to erect them as this wire must be at least 600' long before any marked improvements will be noticed at 200m.

The great majority of amateurs have to resort to loops for their directional effect and the reduction of static, and at amateur wave-lengths most of the benefits of the loop are often thrown away in an attempt to use multi-stage radio amplification, when for all practical purposes better results could be obtained with a simple regenerative set or the regenerative tuned radio frequency plus one good stage of audio frequency amplification. However, so far as static is concerned the loop is of little advantage. True, less static will be received on a loop than on an aerial, but less signal strength too will be received and the ratio of signal strength to static as applied to distant signals will be practically the same in most localities, and actual benefits may be derived only when the source of static is at or near right angles to the direction from which it is desired to receive. Unfortunately, in most localities static generally seems to come from all directions with practically equal intensity and the amateur should not expect much advantage in this respect by the use of a loop.

(Continued on page 626)

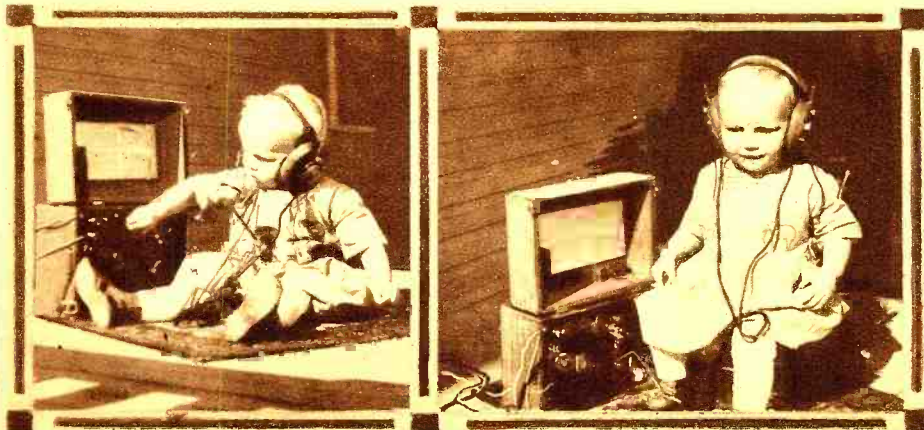

Some Amateurs Start Early, and Quickly Learn How to Tune a Set. This Young Chap Can Tune in a Bedtime Story All by Himself.

# Radio Entertains Boy Scouts at Camp Glen Gray

By GILBERT BONNELL

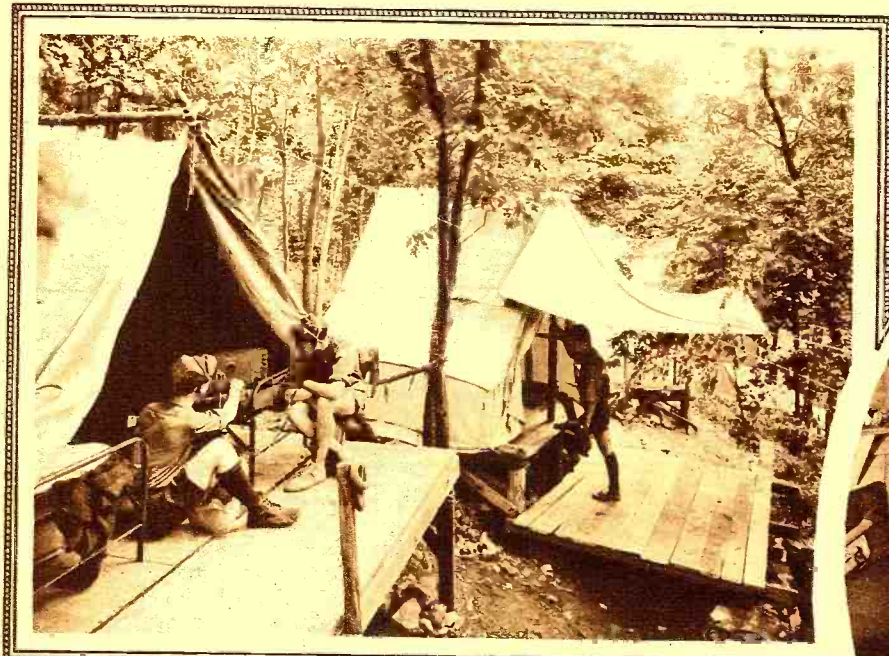

A Typical Scene At Camp Glen Gray, Where Many Boy Scouts Spend Their Summer Vacations. Considerable Interest Has Been Shown In Radio As May Be Surmised From This Photo of Two Scouts Listening To Some Distant Broadcast Station. © Western Electric Co.

Address System made the announcements at the Willard-Johnson fight audible to 74,000 fight fans. The horns uniformly and distinctly carry the amplified voice or music



Here Is "Dave" the Colored Cook At Camp Glen Gray, Who Is Quite Musical. By the Use of a Western Electric No. 3 Public Address System and a Loud Speaker, He Fills the Camp and Surroundings With the Good Old Negro Tempo of His "Coon Songs." © Western Electric Co.

**R**ADIO is the great boon for boys, particularly those who are members of the world's largest boys' organization, the Boy Scouts. Boys are ardent radio fans; they find rare enjoyment and entertainment in the ether; they sport with its waves, as do skillful swimmers in the sea.

A notable example of how radio plays a leading part in the program of the camp day is at Camp Glen Gray, the Montclair Council Camp in Bergen County, New Jersey. There in the Ramapo Hills where the red man's watchfires once gleamed is the campfire of the first Boy Scout troop organized in the United States.

Around that campfire the Boy Scouts of Montclair, Glen Ridge and Nutley, nightly gather and listen to the voices of invisible singers miles away across the mountains. As a matter of fact, the boys could as easily hear the singing in any other part of the camp, for radio programs are made clearly and distinctly audible over all of Lake Vreeland and the full length and breadth of the camp situated on the lake shore. This is accomplished by means of the Western Electric No. 3 Public Address System which P. M. Rainey and R. M. Hatfield of Montclair brought to the camp where their sons are sojourning.

This Western Electric No. 3 Public Address System, while compact, is capable of amplifying radio reception some several thousands of times without distortion. It is a vacuum tube amplifier similar to, but smaller than the one which made President Harding's inaugural speech audible to the largest assemblage that ever heard a speech of the kind. It is mounted in a hardwood cabinet containing an insulating panel upon which are mounted four vacuum tubes and the necessary transformers, resistances, condensers, switches, etc., for three stages of amplification.

The public address system may be used

to amplify radio received programs or, when connected with the microphone, it may be used to amplify local speeches and vocal

## Hearing Radio Concerts Through Your Teeth

**T**HE OZOPHONE, a new instrument invented by H. Gernsback, makes it possible to make the near deaf and those hard of hearing enjoy concerts THROUGH THEIR TEETH. The instrument has been demonstrated before scientific bodies and institutions for the deaf in New York City. Read about this latest scientific marvel in the November issue of SCIENCE AND INVENTION.

## Radio Articles in November Science and Invention

An Efficient One-Tube Portable Radio Set, By H. E. Hayden.  
Radio for the Beginner—"One-Wire Aerials," By Armstrong Perry.  
Short-Wave Broadcast Relaying.  
Radio on French Trains.  
The Cockaday Circuit—with Full Details.  
The R. C. Detector and Two-Step Amplifier.  
Crystal Detectors, By A. P. Peck.  
All Wave Reinartz Circuit, By Kenneth Harkness.

## Look for the Gold Cover

and instrumental music. A group of horns is mounted on the balcony of Mothercroft, the recreation hall at Camp Glen Gray. These horns are exactly the same as those used

in the Yankee Stadium when a Public over the area it is desired to cover at the camp.

Camp Glen Gray was established in 1917 by "Uncle" Frank F. Gray who organized what is the oldest Boy Scout C troop in this county, Troop 4. The camp is located on the shore of a lake in the Ramapo Hills about four miles from Oakland, New Jersey. This section of the country was deserted in '49 by the settlers who went to California in the gold rush. Today it is a veritable forest primeval. The camp consists of a spacious mess hall and kitchen, a large recreation hall, the hospital, the director's cabin, a store and long streets of tents. Each boy has a tent all for himself.

A wash house with running water, and a latrine complete the camp.

The camp is governed by the boys. They have their own mayor and ward leaders. "Co-operative discipline" is a feature of the boys' form of government.

They can take an all day hike on their own land for the Montclair Council Camp's tract covers approximately 600 acres.

The Cannon Ball Road—so called because the Tories in yesteryears hauled cannon balls over it from Pompton to West Point—passes through the property. Today the ruts worn by the wheels of the Tories' carts are obliterated; the old road is but a trail leading to the Lookout from which on a clear night the lights of Manhattan Beach can be easily seen.



# Station 2BGM, New York City

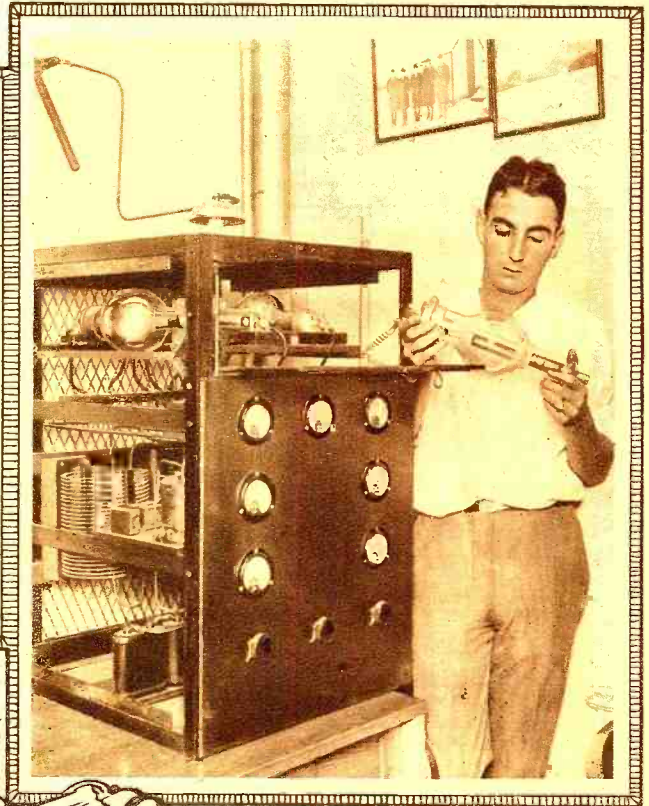
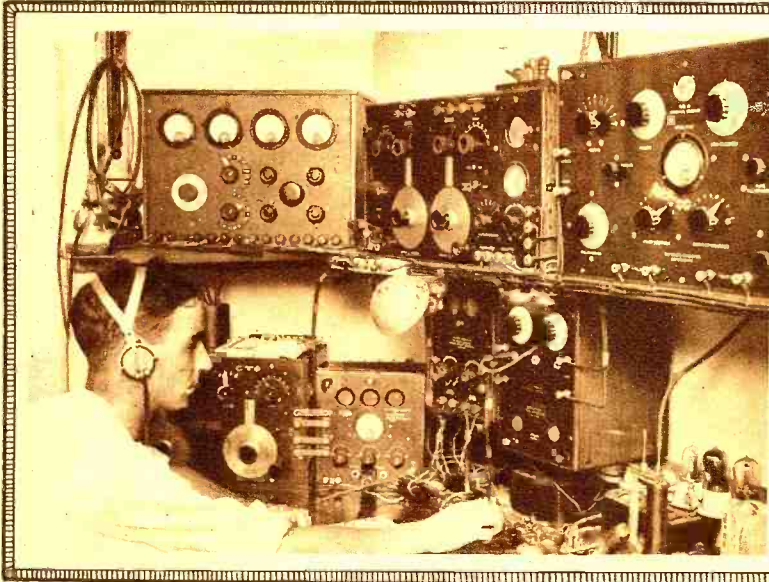

You Know Mr. Inman in Front of the Key, Meet Him Behind It. Hi! This May Look Like Some Layout But You Should See the 10-Tube Super-Heterodyne at the Other End of the Room. His Pet Set, by the Way, is the One on the Left-Hand Side of the Table. It's F. B. on Short Waves.

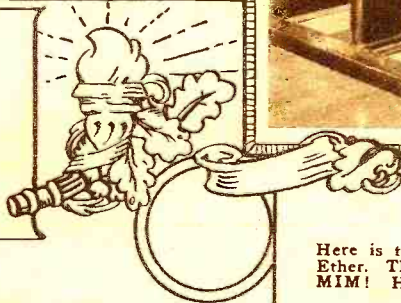

Here is the C.W. Transmitter of 2BGM That Jars the Ether. The Bottle He Holds in His Hand is an Extra MIM! He Uses the Radio Corp. "Intermediate Circuit" and is Well Satisfied With It.

FEW in the broadcast legion realize the unending interest radio holds as a hobby; few have tasted the fruits of accomplishment that the amateur enjoys in the construction of sensitive receiving sets and powerful transmitters, making them give out their best, improving them, possibly at times, reconstructing them, and always tending them as one would a child, fearful of slight damages, created by a love of the things that are a product of their own brains. Self-creations, if you please. The creative genius of the amateur dominates his station; it is his to rule. It serves him admirably. Secure in his room—he has at

his finger-tips the key of the transmitter, the key to the inconceivable space without. A distant signal—a press of a button, an expert "fist" tip-tapping this key and the space is bridged. A hasty greeting and a few messages destined for far-off points, a more than probable "gud nite OM," and the work that is to the amateur a pleasure, is completed. Other greetings and messages come later, from the North where the radiators are hissing, from the South where the fans are purring; the

East and West shake hands, and all the brothers are happy. There is a thrill to it all that can be felt only by those who speak the word of the key.

Mr. W. P. Inman, the owner of an amateur station of the East, situated at 420 West End Avenue, close to the heart of New York City, has, since 1907 followed radio as a hobby. From those grand and glorious years of "free air" he

(Continued on page 654)

## Edward M. Glaser's Station 2BRB

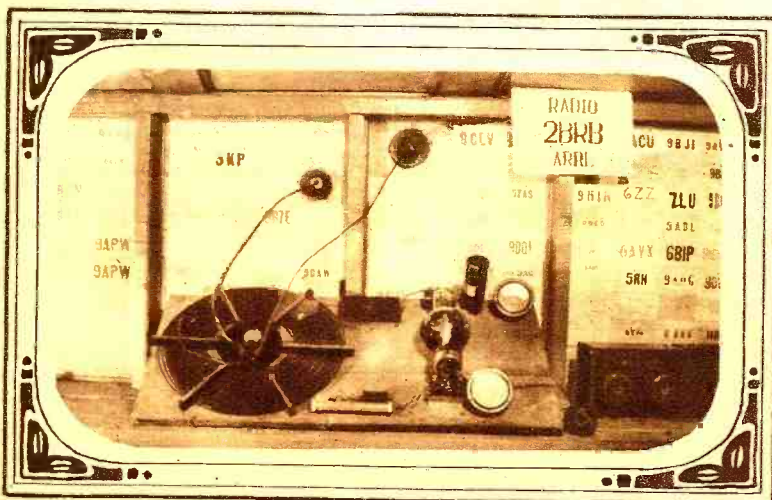

At the Last Moment We Get Word from Mr. Glaser That His 50-Watter Was Heard in New Zealand Three Times. F.B. O.M., Keep It Up.

THE antenna is a six-wire cage 6' in diameter and 60' long. The high end, from which the lead-in is taken is 60' above the ground, and the low end is 40' high. The lead-in is a six-wire cage, 5" in diameter. The mast on the roof is 45' high and is made from three 2x6's and two 2x4's. Nine guys, broken up every 15' support the mast. The pole holding up the low end is a 40' pipe.

The counterpoise consists of seven wires, 50' long and 10' to 20' high directly under the antenna.

The ground consists of six boilers buried 6' underground.

The receiver is a home-made Reinartz tuner with a wave-length range of from 100 to 400 meters. The plate coil consists of 35 turns of No. 24 D. C. C. wound on a 4" cardboard tube. The antenna secondary coil has 36 turns and is tuned

(Continued on page 655)

# V. M. Bitz's Station, 6JD

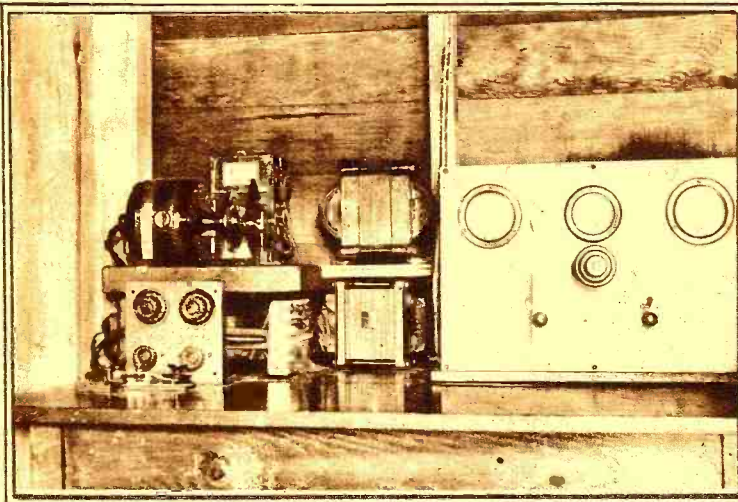

On the Left is a View of the Complete Transmitter. From Left to Right Are the Synchronous Rectifier, the Transformers and the Transmitter. On the Right is a Top View of the Oscillating Circuit and Tubes.

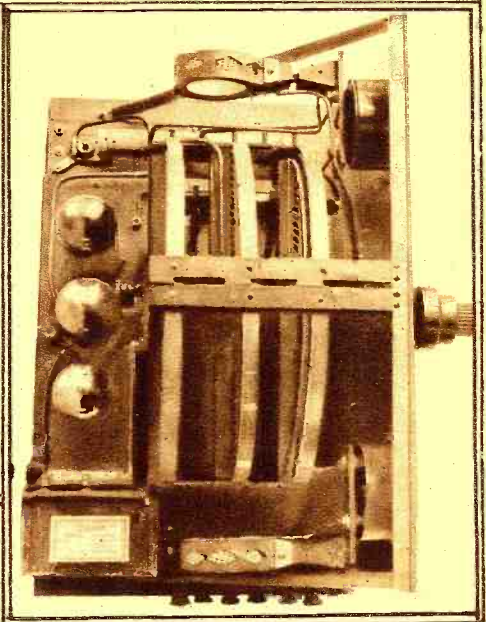

CONSIDERABLE interest has been taken in the trans-Pacific tests on the east as well as the west coast. The fact that the distances expected to be covered on the Pacific coast were much greater than any on the Atlantic placed doubt in the minds of many amateurs as to whether the tests would prove a success. Not only did the Pacific test live up to the highest expectations of the west coast amateurs, but far exceeded the imagination of the majority. Phenomenal distances were covered with powers as low as 5 watts.

We have all read the reports resulting from this undertaking, but few are acquainted with the stations that bridged the immense gap from the west coast of the United States to Australasia. Mr. Bitz's Station 6JD was heard there numerous times during the test. A description of his transmitter follows:

The antenna consists of two wooden masts 80' high and 50' apart, these supporting a 9-wire cage aerial 48' long. The wires are spaced with hoops made of 3/4" copper tube, these being 7' in diameter at the free end, tapering down to 1' at the lead-in end. The lead-in proper consists of a 4-wire cage 6" in diameter and 80' long. The radial counterpoise consists of 10 strips of copper ribbon 3/8" wide and 50' long and is situated directly under the antenna.

The transmitter consists of three pan-cake coils, 16 turns each, with sliding contacts controlled by knobs on the front of the panel. There are three sockets mounted on the rear of the panel to accommodate two 50-watt tubes and one 5-watt tube. When the 5-watt tube is used, the 50-watt tubes are raised up so that the pin in the tube base rests on top of the socket, thereby cutting them out of the circuit. The same method is used with the 5-watt tube when the 50's are used. The radiation of the 5-watt is two and one-half TCA with 140 milliamps on the plate at 900 volts. A distance of 2,000 miles has been covered with this arrangement. 6ZAC and 9DKY were both worked and considerable traffic handled. The radiation with the two 50-watters is seven TCA with 450 milliamps at 1,750 volts. The best work was with 2ACB, during the month of May, 1923, through heavy QRM. The signals have been reported from all parts of America, Hawaii, New Zealand and Australia. During the test with Australia, one 250-watt tube was used, mounted temporarily over the 5-watt tube socket. With this, the radiation was eleven TCA with 500 milliamps at 2,000 volts.

The plate supply for this equipment was supplied by a Synchronous rectifier, the motor being built by the owner. This runs 3,600 R.P.M. at 60 cycles and gives a very quick break with a 4 1/2" disc.

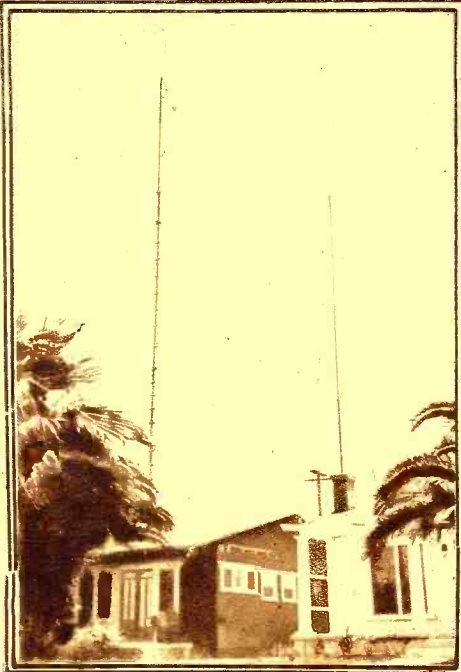

The Cage Aerial of Station 6JD.

Practically all reports from distant stations state that the signals from this equipment are pure D.C. During the test with

Australia, arrangements were made for the stations to send their code letters and calls. After about a week of that kind of signaling, the operator at 6JD asked for a message from the *Radio Journal*, and without pre-arrangement proceeded to send messages to the listeners in Australia. The first one started on Saturday morning, May 16th, as follows:

"Send calls of first ten stations heard, will pay half tolls. Sig., *Radio Journal*."

On Tuesday, May 19th, the cablegram arrived with calls of the first ten stations, thereby letting us know our signals were being heard and copied. Two more messages were sent and copied by listeners during the tests. These messages were also copied by two listeners in New Zealand, one station reporting the signals from 6JD readable 50' from the loud speaker, using two steps of radio, detector and two of audio amplification. Also many reports from operators in all parts of the United States and Canada, who copied these messages complete.

Mr. V. M. Bitz, who has been the chief operator of KHJ since they installed their Class B station, is now associated with the Radio Sales and Service, 820 West 7th Street, Los Angeles, Cal. He will be in charge of the public service bureau, which will give all kinds of information on matters pertaining to radio to the public.

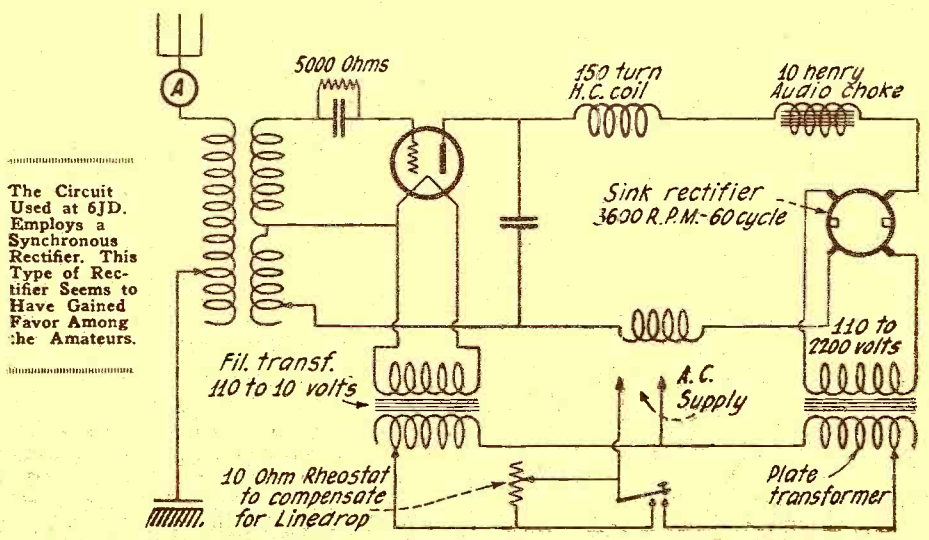

The Circuit Used at 6JD. Employs a Synchronous Rectifier. This Type of Rectifier Seems to Have Gained Favor Among the Amateurs.

# My Moduloscope

By JOHN L. REINARTZ, 1QP

ORIGINATOR OF THE REINARTZ CIRCUIT

**A** GOOD many experimenters are always stumbling onto something that the rest of us would like to try also. The reason why we don't is that the other fellow keeps his discovery to himself. It is only through magazines such as RADIO NEWS and other worth while periodicals that we become acquainted with each other. I wish the editor would see just how much good he could perform in bring-

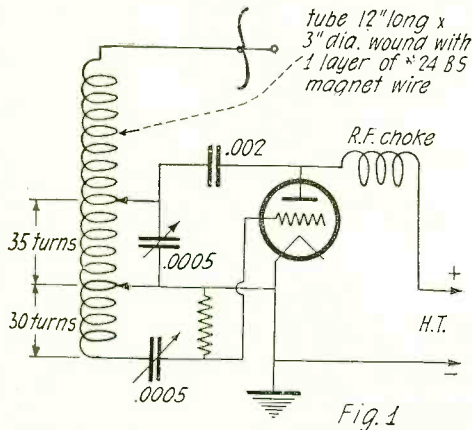

This Circuit Was Used by Mr. Reinartz for Testing Antenna Insulators. A 5,000-Volt, 1,500,000 Cycle Current Was Developed for This Purpose.

ing to life a fraternal order of experiments—such as during the life of the little pocket size Everyday Engineering with its work shop in New York City where one could get model work done. The spirit of that time still stays with me and is quite a factor in my experimental work. It is also the reason for giving to the rest of you what knowledge I have been able to extract in that fashion.

Answering "yes" to a question put to me a few months ago relative to be willing to test a bunch of antenna insulators has led to the finding of a way to readily and cheaply show visually, the form of modulation the carrier wave happens to be subjected to at any amateur transmitting station.

The series of happenings which terminated into a full fledged moduloscope can be briefly told, using circuit No. 1 as a high frequency exciter for the testing of antenna insulators at 1,500,000 cycles and 5,000 volts, showed that it had a tendency to persist in a corona discharge at any and every place near its high potential and where there existed ever so small a point or a bend of less than a 3" radius.

These defects in wiring had to be eliminated to assure correctness of the insulator loss readings and these very losses were the reason for discovery of a very useful device.

Several weeks after the conclusion of the insulator tests, a desire to play with the high frequency corona discharge led me to add to the turns of inductance in circuit No. 1 so that I might be able to obtain even greater voltage. The result was that I was able to draw a 2" spark from the high voltage end, which while not dangerous did burn rather badly at the point of contact.

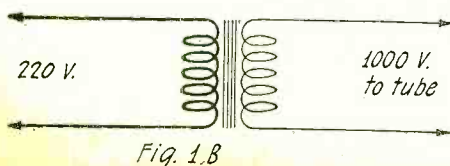

The Effects Are Apparent in the Photo of No. 1 When No Rectifier or Filter System is Used.

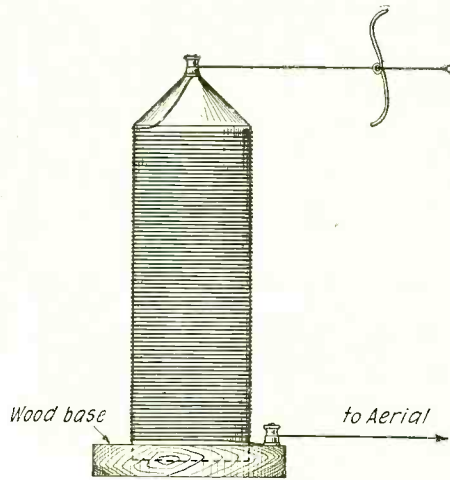
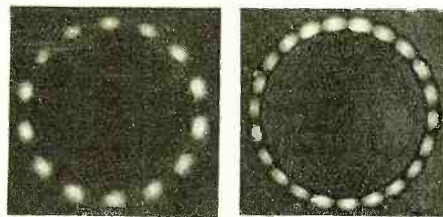

Fig. 7

A Line Drawing of a Completed Moduloscope.

While engaged in the pastime of watching its perambulations at the end of a piece of No. 26 wire a foot long, it became apparent to me that the thing had a very definite cycle of movement, in fact it described a figure "8" persistently, sometimes vertically and sometimes horizontally and allowed a very interesting evening to be spent in watching it. All this was being done while using 800 volts chemically rectified A.C. current.

Having a desire to see the effect when using plain A.C., the rectifier was cut out and the set started. If the first discharge were termed pretty, then this discharge would be doubly so—streamers 3" and 4"



(Nos. 1 and 2.) Effects Produced by the Moduloscope with Poor Rectification. Note the Frequent Current Interruptions.

long shot into space from the wires and the figure "8" effect became so pronounced that it described a 6" size figure "8." The most remarkable part was the periodic omission of the streamers or rather the dark and light spots in the figure "8" which made it look like an electric sign where the lights appear to be chasing each other. Decreasing the voltage to the tube had the effect of slowing down the chasing effect to the point where the lights stood still, making it look like a horizontal figure "8." Reducing the voltage still farther made the lights chase each other in the reverse direction.

Remembering the effect of static current on the spinning wire induced me to try the same stunt and some time was spent bending the small wire so that it would balance and be driven by the tiny amount of power available through a corona discharge. The result was so interesting that it became very fascinating. Proper adjustment of the supply voltage made the light and dark spots stand out so plainly that the next thought was how nice a picture of it would look. Therefore, I took pictures, a few dozen of them, using A.C. both half cycle and rectified, then

filtered, or rather what I had considered filtered—it was not, judging by the humps in the picture.

A new study then represented itself. Why not use this device to tell at a glance how badly the carrier wave was effected by the supply current? And to be able to do this

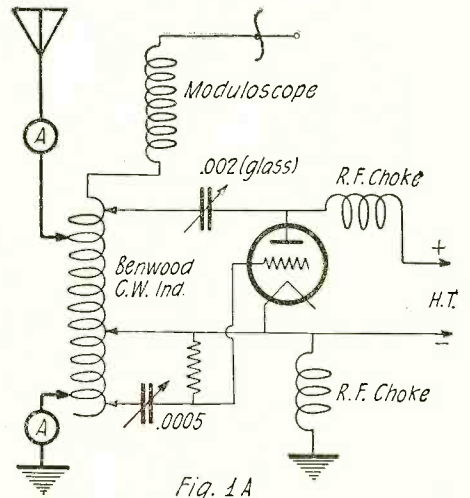

Fig. 1A

The Moduloscope Used in Conjunction with a C.W. Transmitter Employing the Colpitts Oscillator Circuit.

without costly laboratory equipment became a possibility at once. Nearly 200 pictures were taken, some good and some bad. Fig. 1 is a bad one, but a few of the light spots showing. This was due to too rapid exposure. It must be remembered that the spinner was running in synchronism with the 60-cycle supply current in such a manner and at such a speed that twice the number of light spots showing in the circle multiplied by the number of revolutions of the spinner in one second equalled 60 in the case of rectified A.C. and by four times the spinner speed in the case of A.C. current. Therefore, if the speed of the spinner was six revolutions per second and the circle showed 20 light spots, then the exposure had to be one-sixth of a second to get them all in the picture. A whole series of pictures were then taken of the different filters made up for the purpose. The results are as shown in Nos. 1, 2, 3, 4, 5, 6 and 7 and the filtered circuits shown by Figs. 1B, 2B, 3B, 4B, 5B and 6B.

Picture No. 1 shows plain A.C. fed to the tube without rectification; it is my opinion that this same plate supply is responsible for tube troubles as the streamers in this picture could be made to be 3" long and would puncture their glass.

Picture No. 2 shows A.C. chemically rectified and proves that more energy is fed to the antenna.

Picture No. 3 has a 1-Mfd., 1000-volt condenser placed across the supply from the rectifier.

Picture No. 4 has had a 2-Mfd., 1000-volt condenser placed across the supply from the rectifier.

(Continued on page 588)

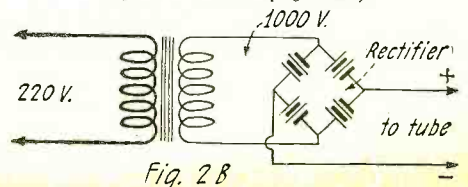

Fig. 2B

Quite an Improvement is Noticeable When Using a Rectifier.

# High Frequency Resistance

By D. R. CLEMONS

Radio Instructor, Dodge's Radio Institute

**T**HE present treatise is an attempt to place before the reader information and data relating to high frequency resistance of inductor coils used extensively in the radio receiving circuits at this time. This material, no doubt very imperfect, may be of some importance to students especially since at this period one's days are so taken in mastering essentials of theory that extensive research in any subject is rarely possible. Faraday remarked that an experiment was never really clear to him

to cause energy to be expended in the circuit, which energy reappears as heat due to the considerably greater atomic activity of the metallic components.

Now, against a continuous flow of electricity, a certain opposition is present which is expressed numerically in units called the ohm. A wire is measured and found to have, say, 3 ohms; a transitory of slowly pulsating current changing intensity at, say, ten times a second, now is started in the wire. The coil's resistance remains prac-

thus causing a variation of magnetic tension. The dependent characteristics of an electromagnet being determined, its strength is then dependent upon the current in it. Hence, in a radio circuit, it is desirable to have the greatest possible current in the oscillatory system, which intensity will be dependent upon the applied potential and the resistance at that resonant frequency. With a given potential the current increases as the resistance becomes less. A primary inductance coil may be included in the antenna circuit. A potential at radio frequencies exists between the antenna and ground, and when the system is adjusted to resonance, the current in it is large or small according to the resistance of the system. Of course, for a large current, it is necessary to design the system for minimum resistance in order to reduce the energy loss as heat in the circuit.

The useful product of an inductance coil is either its magnetic field or a potential difference across it, due to its self induction. If we desire these, the greatest possible ratio of energy must be periodically stored as magnetic energy. If electrical energy leaks away from, or is lost as heat in overcoming resistance of the coil, then such lost energy is not effective as magnetic energy, which, of course, lowers its potential difference. Each period will permit energy to be lost as straight leakage or as heat in the copper which impairs the efficiency of the arrangement. Although resistance does not alter a circuit's resonant frequency, it does cause a loss of energy continually and reduction of final signal strength. The ratio of resistance to inductance is very important in the study of transient currents.

### ENERGY LOSSES

In an inductance coil magnetic energy is all important. It is the useful component, and its intensity represents a final signal intensity. Electrical energy expended in any way as leakage about the coil, or in overcoming copper resistance, is wasted and represents a total loss. The power factor of a coil concerns these losses. A coil having a good power factor would have a very low energy loss due to resistance and a high magnetic reserve, while a coil of poor power factor is a coil in which a great loss of energy occurs due to resistance as compared with its magnetic reserve. Hence, any operation which reduces the resistance of a coil improves the power factor. Such improvement can be made by carefully designing its geometry, use of specially stranded cables, and improvement of insulation

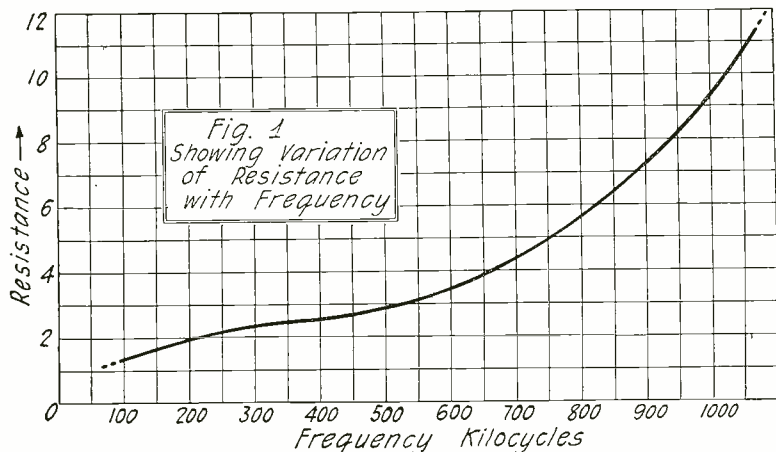

The Resistance of a Coil of Wire Increases as the Frequency of the Current Flowing Through it Increases.

until repeated by himself. Principles of most subjects can be mastered by diligent and systematic reading, but it seems that no subject becomes clearly fixed until a practical demonstration of theory has been given.

It has perhaps occurred to many that experimental descriptive proofs of theory together with results obtained would be of assistance to many who have no means of doing such work. Hence this attempt will consist essentially of practical theorem pertaining to subjects to be discussed, description of apparatus employed, methods of measurement, results and remarks which may be of assistance to the reader in forming an opinion. Subject material may be found in many radio text books, or readers may refer to an excellent article by Prof. Morecroft upon a similar examination contained in the August, 1922, Proceedings of Radio Institute.

### RESISTANCE

Electrical currents within a metallic conductor encounter resistance which may be considered a reluctance of metallic atoms to give up, or when electrically balanced, to receive additional electrical charges into their structure. Having energy suspended and moving at a rapid rate through a wire, an electron may be best imagined as a particle which, in plunging through successive atomic orbits of the chain, leaves them considerably disturbed, their increased vibrational activity approaching thermo frequencies at which the wire emits heat waves—all due to a certain obstinacy of metals to pass easily the particles comprising the electrical current. Two wooden hoops may be covered, one with tissue paper, another with a head of coarse heavy paper. If a ball be tossed into the tissue hoop it will break through without disturbing the hoop greatly, but the same ball tossed into the hoop having a higher resistance will produce a violent shock on striking the heavier diaphragm. The first structure may be compared figuratively with atoms of silver which pass electricity without causing a great expenditure of energy, and the latter hoop may give a fair comparison of iron to the passage of currents. Hence the effect of resistance is

tically 3 ohms as before. Now if the current is caused to alternate rapidly at, say, one thousand cycles a second, the resistance will be greater, and it will increase gradually thereafter as the frequency increases until at, say, one million cycles in a second, the resistance may become 12 ohms, or may have increased four times. This is due to a redistribution of currents in the conductor's interior and to many other causes to be described later.

### IMPORTANCE OF LOW RESISTANCE

In electrical signaling apparatus it is necessary to employ some recording instrument such as a printer or head-phones employing electromagnets which, energized by an electric current, reproduce the signal in some way. It is very important that the greatest possible recording impulse shall be produced with a minimum of energizing current, which, of course, requires less power to produce a given signal strength at the receiving station. Electromagnets give their strength in magnetic lines of force which are attached to or removed from the magnetic circuit,

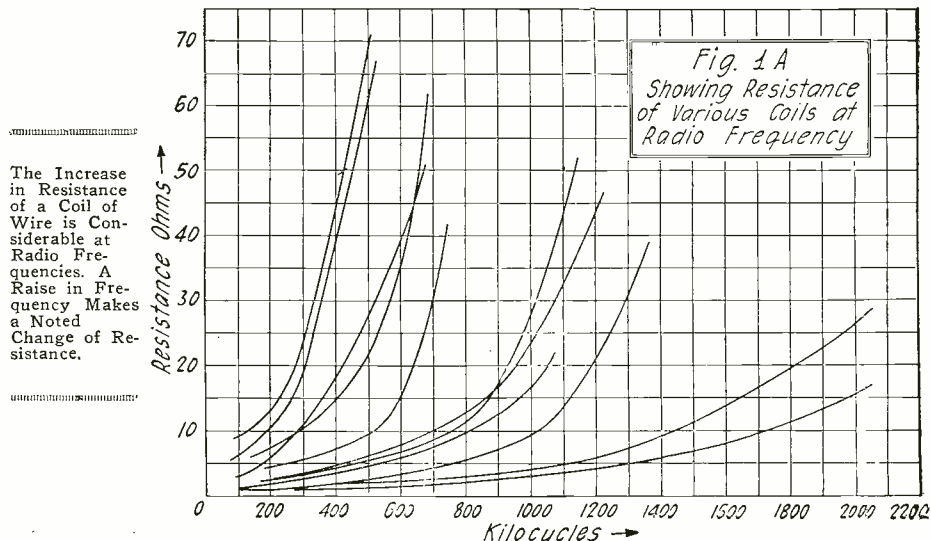

The Increase in Resistance of a Coil of Wire is Considerable at Radio Frequencies. A Raise in Frequency Makes a Noted Change of Resistance.

Coil	Length	Diameter	Turns	Gauge	Kilocycles	Exposed Res. Thoroughly Dry	Varnish	Final Res.	Variation
15	3.40 cm.	13.2 cm.	42	23 d.c.c.	1,000	27.7	Shellac	23.65	-14.5%
16	3.41 cm.	13.2 cm.	42	23 d.c.c.	1,000	27.27	Redmanol	25.21	-8.6%
17	3.40 cm.	13.2 cm.	42	23 d.c.c.	1,000	27.40	Radio Cement	25.10	-8.4%
18	3.40 cm.	13.2 cm.	42	23 d.c.c.	1,000	27.66	Paraffin	24.68	-10.85%
19	3 cm.	10.6 cm.	37	23 d.c.c.	1,000	9.22	Redmanol	8.75	-5%
11	3 cm.	8.2 cm.	117	30 d.c.c.	500	68	Shellac	63.5	-6.7% 3 layer banked
7	2.4 cm.	12.6 cm.	57	23 d.c.c.	500	28.1	Shellac	24.3	-13.5% 2 layer banked
8	3 cm.	12.6 cm.	36	23 d.c.c.	500	4.5	Radio Cement	4.26	-5.2%
9	6.5 cm.	10.6 cm.	176	26 en.	200	28.4	Shellac	26.9	-5.3%
10	1.8 cm.	5.2-8.4 cm.	141	22 silk	200	67.4	Redmanol	58.45	-13.3% Cross-Section Rectangular
14	6.55 cm.	13.2 cm.	103	24 en.	200	10.74	Shellac	10.14	-5.6%

This Table Should Prove of Assistance to Those Constructing Coils.

**ILLUSTRATION OF RESISTANCE VARIATION**

Having now some idea of energy dissipation due to resistance, let us examine an inductance coil of small dimensions to determine exactly its variation with frequency. A pasteboard tube was first treated with an insulating varnish and wound with 37 turns of No. 23 D.C.C. copper magnet wire. Length of winding, 3 cm.; diameter, 10.6 cm.; resistance to direct current, 0.73 ohm. This coil was introduced into a measuring circuit and measured for frequencies up to two million cycles. The curve of resistance in Fig. 1 shows a gradual increase of resistance from 0.73 ohm, its resistance to direct currents; becoming 2.9 ohms at half million cycles (600 meters); finally becoming 9.2 ohms at one million cycles (300 meters) per second. This is characteristic of the increase in most inductance coils used in radio receivers. The reader is reminded that this is not an increase of the coil's impedance, but is an increase of its resistance alone which is really an increased rate at which energy is dissipated in it, which rate evidently increases greatly with the frequency as shown. There are several lines of thought which may explain such an increase.

Consider Fig. 2 in which A is a cross section of copper wire carrying a uniformly distributed continuous current; B represents a wire in which a high frequency alternating current is moving near the surface. Since high frequency alternating currents move near the surface of a conductor, it is evident that a greater current density in that region increases the rate at which energy is dissipated in that section, and that in this condition the center or core may be the same as removed from the wire so far as its usefulness is concerned. This effect was first brought to the attention of electricians by Prof. Hughes; and other investigators at that early date found that a tube, in which there was no such dead copper, had equal or better conductance as compared with a solid wire of identical diameter, showing that the useful area of a conductor's cross section was, for alternating currents, very near the surface.

An explanation may lead to several lines of thought. Prof. Clerk Maxwell virtually predicted this effect fifty years ago when he developed and showed that a counter electromotive force due to self induction has greatest intensity at the center of the wire's cross section. From this we conclude that a potential difference exists between the center and outer surface which may be of considerable magnitude in coarse wires; hence the outer surface or region presents less opposition to transitory currents, and they are accordingly forced to travel along the surface, only beginning to penetrate deeper as further increment of current is delayed—the period of maximum current—but they are immediately recalled, since in alternating currents an increase is followed by a decrease or withdrawal of current. Hence rapidly changing currents penetrate only a little distance into a solid conductor, and it should be noted that increasing the actual conducting surface would

tend to reduce the rate of energy dissipation in a given length of wire, which greater surface, of course, decreases the resistance of the system.

It is also evident that merely stranding the wire to provide greater surface would not improve it since the strands in contact would be equivalent to a solid. Strands insulated as a parallel bundle, or insulated strands simply twisted, would not reduce resistance materially unless the method of stranding is such that each wire passes from center to outside at intervals along its length, to have alternate position in the cross section of the cable, in which case the currents are confined to the surfaces of each wire, because the counter voltage being at the center in greater intensity affects each strand equally. Such cable is now a standard commercial sold as Litz, being composed of various numbers and gauges of fine insulated wires stranded in such a manner as suggested above. Maxwell, Lord Rayleigh

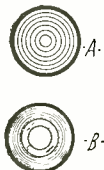

Fig. 2

"A" Represents the Distribution of a Direct Current in a Solid Wire. "B" Illustrates the "skin Effect" of a High Frequency Alternating Current in a Solid Wire.

and Prof. Hughes clearly demonstrated its usefulness forty years ago. Such stranded wires, while ideal for inductances, is costly, and in many cases is prohibitive on that account. However, solid copper serves quite well providing it is sufficiently large, and may in some instances show equally low resistances at certain frequencies to coils of similar geometry using a stranded cable.

**RESISTANCE VARIATION WITH HYGROMETRIC CONDITION**

While experimenting with inductance coils, their resistance was found to vary as much as 40 per cent within a period of twenty-four hours. Prof. Morecroft, in the article previously referred to, also mentions similar variations. For instance, a coil showed a resistance of 28.24 ohms at 200 kilocycles at one time, and was found to have 38.14 ohms after having remained in the same position for twelve hours. Such variations seemed at first due to stray effects between measuring and test circuit, but on rearranging circuits to reduce to a minimum such effects of stray induction on the test circuit, the coil was found to show the same variation from time to time as before. On examining other coils, cotton was found noticeably variable; silk changed very little under similar treatment; enameled insulation showed little effect in comparison. It seemed that such variation could be due to leakage only, and such leakage could be the result of different moisture conditions upon the coil itself, hence the investigation led to a study of the

hygrometric effect upon the resistance of inductors; investigation of insulation and the possibilities of improving the coil power factor by the exclusion of moisture. The reduction of resistance by selection of stranded cable could be offset by neglecting the effect of moisture.

**HYGROMETRY**

Hygrometry is a study of moisture conditions in the atmosphere. Now, if a dish of ether, alcohol, or water is placed in a room, we know that after a time all the liquid will have evaporated. The liquid molecules at the surface become accelerated and spring away from the surface into the atmosphere above it where they encounter some opposition due to collision with molecules of air, retarding considerably the rate or rapidity of evaporation. If the liquid were placed in a vacuum it passes into vapor instantly, but due to collision in free atmosphere, the rate of evaporation is reduced.

Heating also tends to increase evaporation by accelerating molecular activity; also if the air over the dish were removed by a fan, the evaporation would be rapid since the blanketing vaporous cloud is continually being removed. Now, if the dish were placed within an air-tight chamber, evaporation would take place for a certain time, after which no more molecules could combine with the air in it, in which state the air in the chamber is saturated. If, however, the chamber is heated by some means, there will again be evaporation until molecules of water are returned to the surface as rapidly as given off by the liquid, showing that the increased temperature allows more water to be suspended for saturation. If the chamber is now suddenly cooled, water vapor must be immediately dropped since air at lower temperatures cannot hold so great a quantity of water for saturation, and water vapor immediately forms upon the walls, which shows that at any temperature there can be a certain quantity of water vapor in a given volume of space.

This means that at one temperature a certain quantity of water vapor can exist for each cubic foot of air, and that, if the temperature is increased, more vapor can exist; but if the temperature were suddenly to decrease, the condition is such that a much smaller quantity of vapor can exist, so the excess is dropped in some way as fog, rain, snow or dew in nature. Although an atmosphere may permit a certain vapor tension or quantity of water, we find in nature that the maximum is seldom obtained since local conditions over the earth may prevent the air above it from receiving sufficient vapor to saturate the atmosphere, as is generally the case over desert areas. Hence the quantity of water present to the quantity of water vapor possible at a given temperature is a ratio conveniently expressed as relative humidity where 100 represents saturation.

(Continued on page 644)

Sample	Time Exposed	Resistance	2nd Exposure	2nd Resistance	Final Resist. after Varnished
Silk	6 hours 49° F.	2300 megohms	6 hours 71° F.	1605 megohms	2410 megohms
Cotton	6 hours 49° F.	207.7 megohms	6 hours 71° F.	104.89 meg.	3484 megohms
Canvas	6 hours 49° F.	44,967 meg.	6 hours 71° F.	25.61 meg.	1154.5 megohms

A Chart Giving the Resistance of Three Materials at Different Time Intervals and Temperatures.

# Design Of An Audibility Meter

By RALPH R. BATCHER, E.E.

THE American Institute of Radio Engineers has defined audibility as "A measure of the ratio of the telephone current producing a signal in a telephone receiver to that producing a barely audible signal. A barely audible signal is one which permits the differentiation of the dot and dash elements of the letters." This is a concise summary of the test of the audibility of a signal, a test which is not particularly difficult to make, even with home-made equipment. This article will take up the main points involved, and a description of an audibility meter that is not difficult to construct.

The main fault with some of the audibility meters available on the market is that an accurately measured receiver is not supplied with the instrument, and the calibration of the meter for quantitative work is useless without it.

of the meter is. Some of the factors that affect the audibility factor, that have been neglected in the simplified formula for the

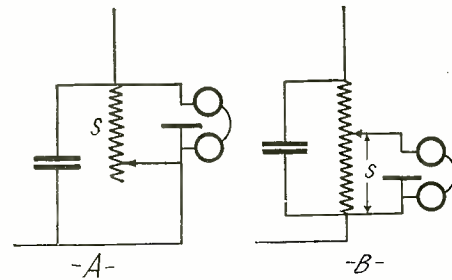

Fig. 1

"A" and "B" Show the Methods by Which the Instrument Can Be Connected to the Output Terminals of the Receiver.

audibility factor (see next paragraph) will cause a slight error, in case the signal audibility is only a little over unit audibility, however, when Type B circuit is used. This has been pointed out by Zenneck in Proc. I. R. E. for August, 1916.

The formula on which most audibility meters are based is:

$$\text{Audibility} = \frac{S + T}{S}$$

where S and T stand for the effective impedances of the shunt and the telephone receiver respectively. It must be remembered that audibility measurements are but relative values, which may differ with different observers under the same conditions, and are affected by external interference and static and with local distractions that may be encountered. The exact formula (or rather a more nearly exact formula) is

$$A = \frac{\sqrt{(S + Rt)^2 + (wLt)^2}}{S}$$

The experimental error, the personal equation of the observer, the change of the resistances due to temperature, and varia-

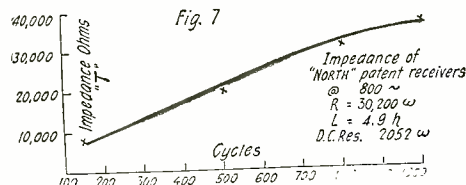

A Curve Illustrating the Increase in Impedance of a Pair of Headphones as the Current Frequency is Raised.

tions in the telephone receiver are so much greater that the use of the more exact formula is not warranted.

The first requisite for an audibility meter is a good headset that is sensitive, and preferably without adjustable diaphragms. Since the impedance of receivers changes with frequency it is essential that the impedance be measured at several frequencies, say at 100, 250, 500, 800, and 1,000 cycles. Fig. 7 shows a representative curve which was plotted from data taken on a pair of telephone receivers. (Note: These receivers were purchased in 1915 and were called the North patent receivers, but seem identical with the original Baldwin types. Recent impedance checks indicate that the impedance of this pair has not varied to any great extent over a number of years).

Figs. 2, 3, 4, 5 and 6 give details of the audibility meter designed by the author.

The main resistance is controlled by a 34-point switch, and has a total resistance of approximately 36,000 ohms. Another variable resistance unit having a total resistance of 18,000 ohms is controlled by the same knob. This latter unit is added for the purpose of keeping the load on the vacuum tube constant. The resistance is distributed over only eight of the 34 points, since on other settings the error is negligible; a second switch arm travels over a five point switch. This switch cuts enough resistance in series with the telephone receiver to bring up the receiver impedance at five representative frequency to 36,000 ohms, which was the value used in computing the values for the other switch.

Actual constructional details will be left to the reader. If desired, the two concentric switch arcs may each have 34 points. The method shown utilizes a curved com-

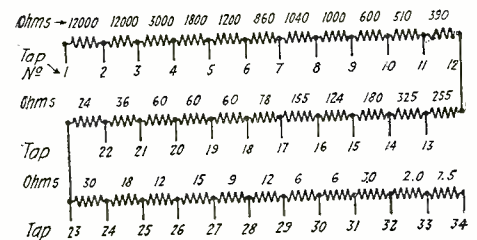

Fig. 3

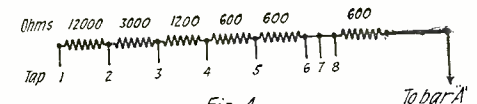

Fig. 4

Fig. 3 Shows the Connections to the Main Switch, Fig. 4 to the Inner Switch

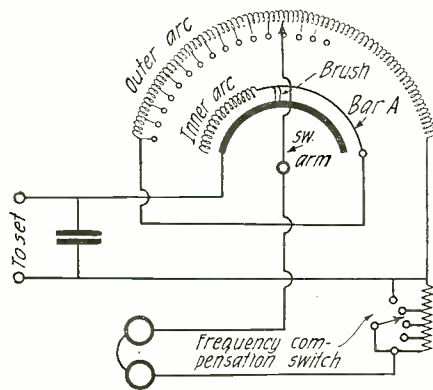

Fig. 2

Diagram of Connections of the Complete Audibility Meter.

Fig. 1 shows two different methods by which these instruments may be connected. Type A is probably the commonest method, although for many purposes type B is to be recommended for general use, for the following reason: The load that the meter as a whole places on the circuit is more nearly a constant quantity, which always can be selected to match the other constants of the circuit.

For instance, when measuring a fairly strong signal with the meter in the plate circuit of a vacuum tube, the meter may require only a few ohms to balance out the signal, and as a result the value of the audibility factor so obtained is not reliable, since the efficiency of the tube has dropped considerably with the low plate resistance. However, with the Type B circuit, the load would be practically constant at all settings. In the meter to be described a special compensating device is used to equalize the load on the tube, no matter what the setting

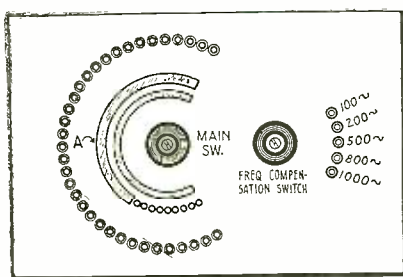

Fig. 5

Top View of the Audibility Meter.

mutator bar to simulate all but eight of the contacts on the inner arc. The inner semicircular bar is used as a brush feeder, or if desired a double switch arm can be used instead of this feeder. Fig. 2 shows the circuit used; Fig. 5 shows how the switches are arranged; Fig. 6 gives details of the main switch lever, showing an auxiliary contact (which is insulated from the main arm) that bridges the inner arc and the brush feeder.

Fig. 3 shows the values for the successive resistance units and the taps to which they should be connected. It should be noted that 12,000-ohm resistance units have been available on the market since the Armstrong "Super" circuits, so that the largest units can be purchased. The other units may be wound with No. 36 or No. 38 resistance wire. All units over 100 ohms should be wound non-inductively, that is, by cutting off the length of wire that will give the desired resistance, looping it at the center and winding from this point.

(Continued on page 639)

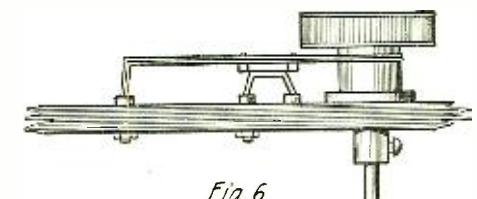

Fig. 6

Showing Details of the Main Switch Arm

# Loop Antennae for Transmission

By ALLAN R. KENWORTHY

**L** OOP antennae are practical for transmission purposes in many instances, especially when it is impossible to erect an outdoor aerial, or where the directive properties of the loop merit its use. As when used for reception, the loop is a very inefficient device, and only under the best of conditions will the effectiveness of the loop approach other types of antennae.

In general, the effectiveness of the loop antenna will depend upon its design and construction, but minor factors, such as its location with respect to imperfect dielectrics in its fields, the wave-length at which it is operated, and, indirectly, the antenna and receiving equipment used at the receiving station, must be considered if maximum results are to be obtained in loop transmission. These factors will be discussed in subsequent paragraphs.

A very practical loop antenna for indoor use is illustrated in Fig. 1, Detail A. The loop consists of two to four turns of 3/4" copper tubing wound on a frame from 3' to 6' square. If copper tubing of the size required cannot be procured, copper strip of 1" or 2" wide may be used. The spacing between turns should be at least 3", and the strips of material which space the conductors should be hard rubber or bakelite.

In constructing the frame, use hard wood, gluing the pieces together in preference to using nails or screws. It is absolutely necessary, if the full efficiency of the loop is to

be realized, that the metal in the field of the loop be kept at a minimum. If desired, the loop may be arranged so that it can be swung in different directions, or it may be suspended from the ceiling of the operating room from insulators or mounted in a vertical plane on the operating table. While it is not absolutely necessary that the loop point in the direction in which it is desired to transmit unless the distance to be covered is very great, it is desirable to have the loop point approximately toward the receiving station. Under ordinary conditions there will be more or less radiation from all sides of the loop, the radiation at a point 90 degrees away from the direction of maximum radiation being less than one-tenth the maximum radiation. It should be observed that in many instances large metal bodies in the vicinity of the loop will greatly distort the directivity of the antenna.

The loop described, used in connection with a 10-watt transmitter, should have a range of from 25 to 100 miles, depending upon the size of the loop and the conditions under which it is operated. With a loop of the size described greater powers than 100 watts should not be used and very little increase in range will be observed in using greater powers.

If comparatively great distances are to be covered with a loop antenna, and the circumstances will permit, an outdoor loop should be erected. Fig. 2 illustrates two suggested designs for such a structure. The loop shown in Detail A can easily be made by bringing leads from each end of an ordinary inverted "L" type antenna and placing a coupling inductance and tuning condenser as indicated in the sketch, with the coupling inductance in the end of the antenna from which the greatest radiation is desired.

The sketch of Fig. 2, Detail B, shows a modification of the Lowell-Willoughby loop designed for use on submarines. This type, too, can be made from the "remains" of an inverted "L" or "T" type antenna, and the claims are made that usually better results will be obtained with the loop than with the original antenna. With this type of antenna the coupling inductance and tuning condenser can be located as shown. The tuning condensers used with a loop antenna of any type should have very low losses and be capable of withstanding very high voltages.

Practically any circuit or transmitter can be used with loop antennae; in many cases it is necessary only to make connections to the loop from the antenna and ground connections of the transmitter. Two circuits

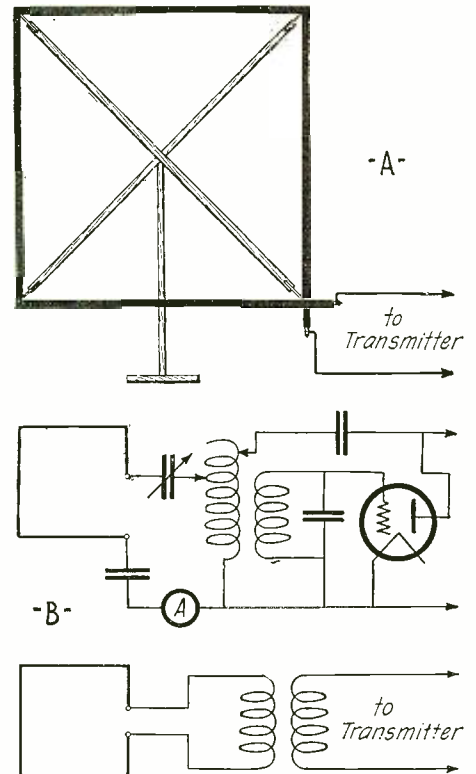

Fig. 1

A General Idea as to the Constructional Details of an Indoor Loop Antenna is Given in "A." Either Copper Tubing or Stripping Should be Used so as to Keep the High Frequency Resistance Low. "B" Shows Two Methods of Coupling the Loop to the Transmitter.

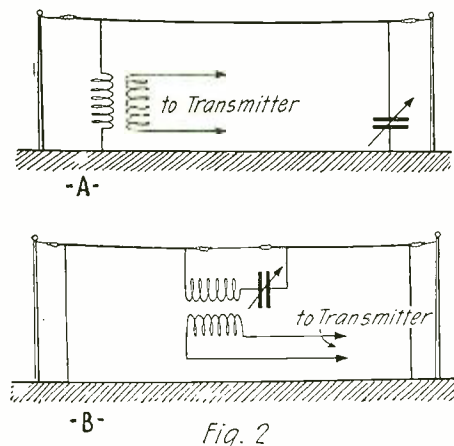

Fig. 2

Two Types of Outdoor Loop Antennae Which Should Prove Quite Efficient. That of "A" is an Inverted "L" Antenna Grounded at One End Through an Inductance and at the Other End Through a Variable Capacity. That of "B" is of the Type Used Primarily on Submarines.

recommended for use with loops are shown in Fig. 1, Detail B. As a rule, the direct connected loops will give better results than transformer connected, but the latter give a more flexible arrangement and are sometimes necessary if the directional properties of the loop are to be fully realized.

In locating a loop antenna, if it is a small indoor structure it should be kept as far away from walls and masses of metal as possible; if the antenna is an outdoor structure, keep it away from trees, buildings, etc. Imperfect dielectrics in the field of the antenna tend to lower its efficiency by absorbing a certain amount of the radiated energy, this effect becoming more pronounced at short wave-lengths.

## Antenna Counterpoise Safety Switch

By HOWARD S. PYLE

**T** HE majority of telegraphing amateurs of the present day are using some form of counterpoise in connection with rather an elaborate antenna system. Little or no attention is paid, however, to the proper lightning protection of their radiating system. When this does receive consideration, it is usually the antenna only, which is protected. A counterpoise, while generally swung comparatively low, is nevertheless an insulated metallic body of considerable surface, and when placed, for example, in an open yard, or orchard, offers the easiest path to earth—through the set for any atmospheric discharges. It should, therefore, receive serious consideration in

the safety scheme. A method is illustrated in the accompanying diagram for accomplishing complete grounding of both antenna and counterpoise through the medium of a single switch.

An ordinary 100-ampere lightning switch of approved type is procured, and the blade bearing and one jaw transposed, thus placing the bearing at one end of the base, with a jaw in the middle and one at the opposite end. The two extremes of the switch connect respectively to the antenna and counterpoise leads, with the center jaw grounded. With the switch in the open position, the radiating system functions for transmitting, and when closed, absolute protection is afforded.

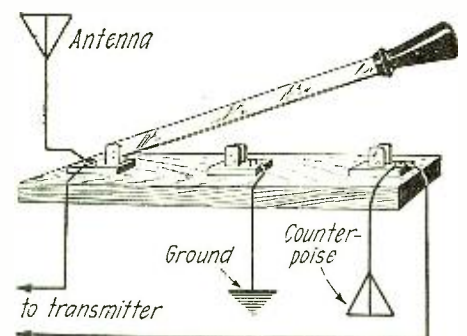

The Connections to the Switch

# Vacuum Tubes for Amateurs

By JESSE MARSTEN

ELECTRON EMISSION, ITS CONTROL, AND LIFE OF TUBES.

EVERY vacuum tube which contains a heated filament operates on the same basic principles, namely the emission of electrons from the heated filament and the control of this electron emission by various means. The practical features of vacuum tube operation and performance are functions, in one way or another, of electron emission. It is, therefore, desirable in the first place to obtain an understanding of the conditions determining this emission.

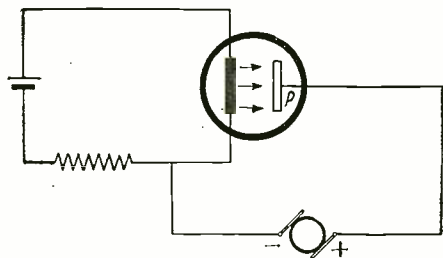

Fig. 1

Flow of Electrons Under Attraction by Positively Charged Plate "P."

### BASIC PRINCIPLE

The whole subject of electron emission is intimately bound up with the theory of electrons and the constitution of matter. Details of these theories are outside the scope of this discussion. A brief statement regarding electrons and their emission from solid bodies is essential, however, to a complete understanding. It is assumed that the atoms of any element are composed of a nucleus, called a *proton*, having a positive electric charge, and a number of negative electric charges, called *electrons*. These electrons revolve about the positive nucleus very much in the manner in which the planets revolve about the sun. The atom is, therefore, regarded as a miniature solar system. The exact number of electrons in any atom and the manner in which they are actually disposed about the positive nucleus varies with each element. Thus the hydrogen atom is supposed to have a positive nucleus and one electron revolving about it. Other elements have more electrons disposed about the positive nucleus in definite ways. The number of electrons an atom possesses and the particular manner in which they are disposed about the nucleus determines the atom and its properties.

The atoms and molecules of any substance, solid, liquid or gaseous, are considered to be in constant rapid motion. Thus the pressure of any gas is explained by the Kinetic Theory of Gases to be due to the impact of the gas molecules against the walls of the containing vessel as they move about. The temperature of any body is a function of this motion of atoms, the greater the velocity the higher the temperature. Thus by heating any substance we increase the velocity of motion of its atoms and molecules. At ordinary temperatures the velocity of motion of the atoms is not great enough to enable them to fly away from the body. However, if their velocity is increased, sufficiently this happens. Thus the evaporation of any liquid is due to increasing its temperature by heating, which is equivalent to increasing the velocity of motion of the atoms of the liquid. When the velocity increases sufficiently the atoms leave the liquid as vapor. In this way evaporation takes place. Some atoms move faster than others. These leave the liquid first. In the

same way we may explain the conversion of a solid into gaseous form, called "*sublimation*."

Just as atoms and molecules are in constant motion in a body, so are the electrons in constant motion in every atom of a substance. The velocity of the electrons is also dependent upon the temperature, increasing with it. At ordinary temperatures the electron velocity is not great enough to enable them to leave the atom. As the temperature is increased the electron velocity increases and if this is great enough the electrons do leave the atom. That this is so may be experimentally proved by the fact that an uncharged body in the vicinity of a heated filament such as tungsten becomes negatively charged. This negative charge is due to electrons leaving the filament and lodging on the neighboring body and imparting their negative charge to it. We thus see that by sufficiently heating a body we may have it emit electrons which carry a negative charge of electricity. Since electricity in motion constitutes an electric current by controlling the motion and path of these emitted electrons we may obtain an electric current which, by proper direction, may be put to use. It is this emission of electrons from hot bodies and its control, which is at the basis of all tube action.

### ELECTRON CURRENT

Although any body if sufficiently heated will give off electrons, in the case of vacuum tubes the source of electrons is a heated filament of wire, either tungsten or a platinum wire coated with oxides of barium and strontium; the reasons for their use are given below. The filament is heated electrically and when it reaches a sufficiently high temperature, gives off electrons. In the case of tungsten, heating to incandescent white heat is necessary, a dull red heat being sufficient for the oxide coated platinum filament. These electrons are expelled from the hot filament with a certain velocity, some high and some low, hence the electrons possess a certain amount of kinetic energy. Consequently, unless there is some other external force to keep them moving their initial energy will soon be used up before they get very far from the filament. If there is no such external force and the filament is continuously emitting electrons, some of the expelled electrons will return to the filament, for when the negative electrons leave the filament they carry with them negative charges. The filament is, therefore, left with a resultant positive charge

which attracts negative electrons to it. However, soon a condition of equilibrium is reached where the amount of electrons expelled per second is just equal to the amount returning to the filament per second. If, however, we place a positively charged plate in the vicinity of the hot filament it will attract the negative electrons, leaving the filament. Its force of attraction will depend upon the voltage to which it is charged and its distance from the filament. If it is made high enough its electrons will flow to the plate and register on an ammeter. This is, therefore, an electric current, or electron current, and it is this current we have to deal with.

### CONDITION FOR TRUE ELECTRON CURRENT

When the current is due solely to the travel of electrons emitted from the hot filament we have a true electron current. If any gas is present, this will not happen, for the motion of the emitted electrons results in their colliding with gas atoms. This collision results in ionization, that is, the gas atoms separate into negative electrons and positive ions which are also subject to the force of the plate voltage. Hence, these electrons and ions add to the current. The condition for true electron currents, therefore, is a perfect vacuum where the motion of the expelled electrons can interfere with no other bodies. Air must naturally not be present, else the heated filament will oxidize and burn.

### SATURATION CURRENT

If the positive voltage on the plate, Fig. 1, is increased, its force of attraction on the emitted electrons will also increase and it

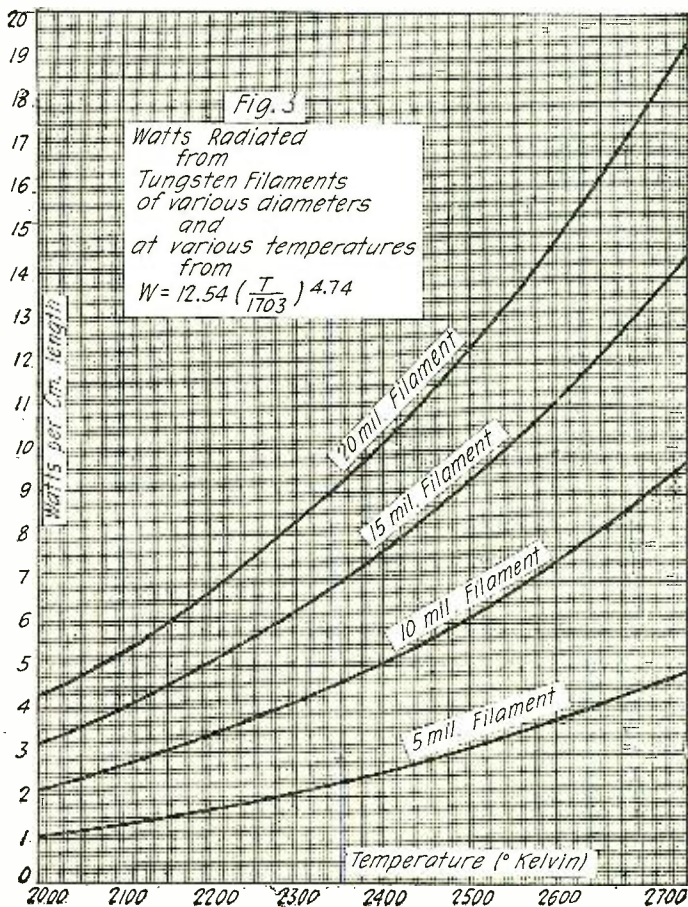

These Curves Clearly Show Why Bigger Filaments Are Used in Transmitting Tubes.



will therefore attract more of the electrons to it. However, at any given temperature  $T$  of the filament only a definite number of electrons are emitted per second. When the positive voltage on the plate reaches a value where it is strong enough to attract all of them, the electron current for these conditions is at its maximum value. If the positive plate voltage is increased no further increase in electron flow can take place because it is already attracting all the electrons which the filament can emit at that temperature. This value of current is called the *saturation current*.

**HOW EMISSION VARIES WITH FILAMENT TEMPERATURE**

It has been definitely established that the emission of electrons from a hot body varies with its temperature in exactly the same way that the rate of evaporation of a liquid varies with its temperature. The higher the temperature of a liquid the more rapidly it will evaporate. In the same way by increasing the temperature of the filament we can increase the rate at which electrons are emitted, hence we can increase the total plate current obtainable and so increase power. But this has serious limitations, as will be seen below.

**ELECTRON EMISSION FROM TUNGSTEN FILAMENTS**

In Fig. 2 are drawn curves showing the electron emission per cm. length of filament from tungsten wires of various diameters, tungsten being one of the principal materials used in vacuum tubes. These curves are calculated from the Richardson equation, as were all of the following curves, by Mr. R. J. McAvsland, Jr., formerly of the Marconi Wireless Tel. Co. of America. This curve shows the manner in which emission varies with the temperature of the filament. It will be observed that the lower temperatures as between 2200 degrees and 2400 degrees the emission is low and the rate at which the emission increases with temperature is also low. But above 2400 degrees the emission rises very rapidly with small increases in temperature. The operation of the filament around these tempera-

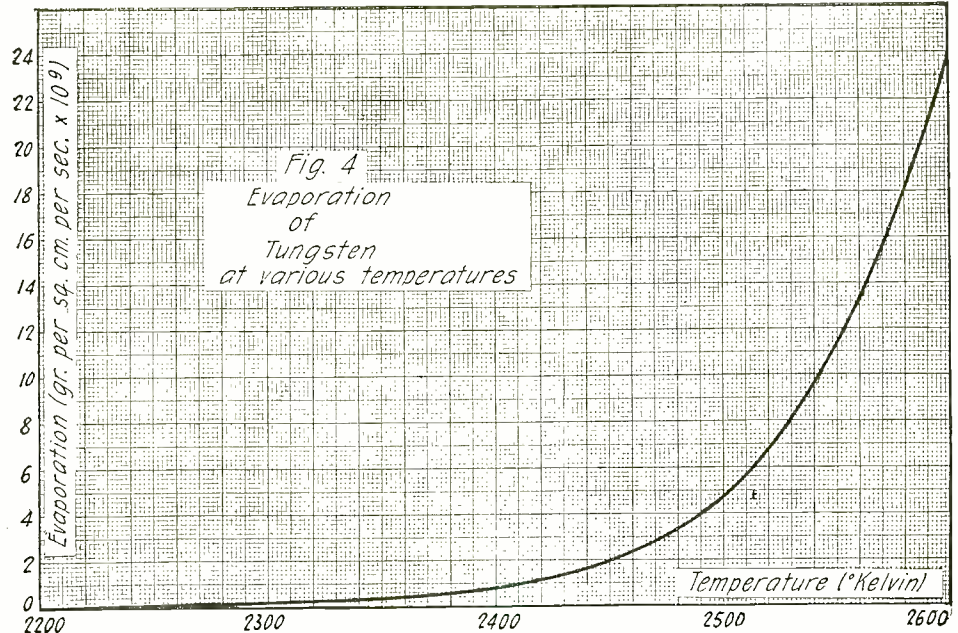

Above a Certain Temperature the Evaporation of Tungsten Becomes Much Greater for a Small Increase, Reducing the Life of a Tube if Burned Too Brightly.

tures, therefore, namely 2400 to 2500 degrees, is critical; that is, small temperature increases produce large current increases. This has an important bearing on the life of tubes, as will be shown below. It will be observed that for the same temperature the larger diameter wire gives more electron emission, since there is greater surface to emit electrons. Tube filaments must be designed to give certain emission for the purpose in hand, thus transmitter tubes must have greater power than the receiver tubes hence the filament emission must be greater. Thus larger diameter wire is used for the filaments of transmitter tubes.

**POWER REQUIRED TO HEAT A TUNGSTEN FILAMENT TO DEFINITE TEMPERATURES**

From the above we see that in order to secure a given electron emission we must heat the filament to a definite temperature. This is accomplished by an expenditure of electric energy in the filament, utilizing the heating effect of an electric current. There is a certain relationship between the electrical energy consumed by the filament and the temperature to which it raises the filament. This may be expressed by a mathematical equation, but the relationship is much better by means of curves as shown in Fig. 3. These curves show the energy consumption of tungsten filaments per cm. length for various diameters of wire and the temperature to which the filaments are raised. It will be observed that the smaller diameter filaments require less filament consumption to raise them to given temperatures than the larger diameters. Thus to raise a 5-mil. tungsten wire to 2400 degrees requires an expenditure of electrical energy of 2.55 watts per cm. length, whereas the 10-mil. filament requires 5.1 watts per cm. length. This is to be expected since

there is less mass to heat up in the thinner wire, and the thicker wire has more radiating surface. Receiving tubes thus use up less filament power than other tubes. Although they use less power they are still operated at almost the same high temperatures as the transmitting tubes, hence they must be given the same care in order to prevent low life.

**EVAPORATION OF TUNGSTEN**

This factor has a most important bearing on the life of vacuum tubes. At these high temperatures necessary to produce the requisite electron emission, vaporization of the filament material takes place. This is evident from the colored deposit seen on the glass walls of the tube. At such high temperatures tungsten begins to vaporize. Tungsten vapor leaving the filament reaches the relatively cold glass wall of the tube and condenses there, leaving a solid film of tungsten. Evaporation of the filament decreases the diameter of the filament, hence increases the resistance of the filament, varies the energy consumed by it and thus produces a variation in the electron emission as time passes. It is, therefore, important to see the bearing this has on the practical operation of tubes. Fig. 4 shows how the evaporation of tungsten varies with the temperature. It is seen that evaporation increases very slowly at temperatures below 2400 degrees, but above 2400 degrees the evaporation increases at a remarkably rapid rate. It is, therefore, evident that the filament life will depend upon the rate at which the filament material evaporates.

**LIFE OF TUBE**

In practice filaments must be worked to last as long a time as possible, renewal costs being very high. It is seen that the life of a tube depends upon the temperature at which it is worked. Thus, from Fig. 4 we see that a filament operated at 2490 degrees evaporates twice as fast as one operated at 2452 degrees, hence will last half as long. It is, therefore, necessary to decide on what is the life of a tube, especially so since the electron emitting properties also vary with the age. The life of a tube is arbitrarily defined as the *number of hours it takes for the diameter of the filament to decrease by 10 per cent of its initial value*. The life of a tube is considered as over regardless of whether the filament is intact or not, so long as its diameter has decreased 10 per cent.

**SAFE TEMPERATURE**

This decrease in diameter may be ob- (Continued on page 568.)

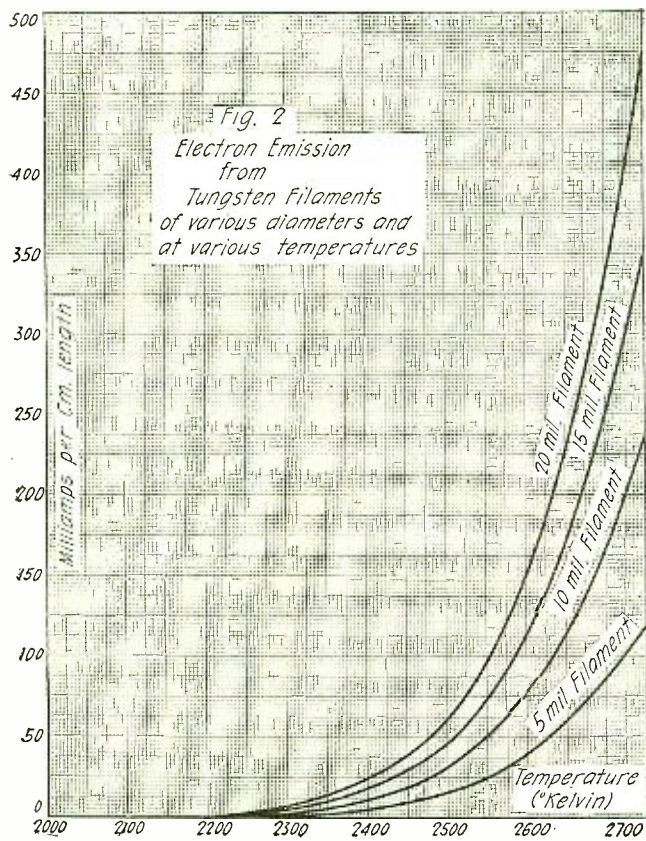

The Surface of the larger Size Filaments Emits Much More Electrons for a Given Temperature.

# A Voltage Raiser for C.W. Transmitters

By MARCUS G. SCROGGIE, B.Sc., English 5JX

**B**EFORE installing transmitting equipment one is usually faced with the problem of devising a method of obtaining a suitable high voltage. This new method, applicable to stepping up the voltage of direct current mains, is particularly simple, and the apparatus easy and cheap to construct. The principle can be applied for obtaining a smooth, high voltage direct current from an induction coil having an interrupter synchronized with the distributor and deriving current from a low voltage battery. The

are nowhere in this country of above 250 volts, this method is unsatisfactory for higher powers as the filaments have to be run very brightly to get the necessary plate current, resulting in a rapid disintegration of the filament, or else a number of tubes must be used in parallel, leading to low efficiency all round. To those who cannot afford a motor generator to give 500 to 1,000 volts, or to be continually buying batteries, the following description may be of interest. The method which has been worked out consists in connecting a number of con-

current,  $I$  amps, is practically constant during time  $t$  seconds of discharge, this may be altered to  $C = \frac{It}{V}$ .

If the average value of the output voltage on load is 90 per cent of that on no load, then approximately the minimum voltage across any condenser is 80 per cent of the maximum, or  $V'$  is 20 per cent of the supply voltage, so if the interval  $t$  between charges is 0.02 sec. and the output current is 0.02 ampere (representing about 16 watts), the required capacity of condenser is

$$0.02 \times 0.02 \div (230 \times 0.2) = 0.0000087 \text{ farad, say } 10 \mu F,$$

to allow a little margin.

The charging is accomplished by the machine to be described, the design of which may be varied considerably, but this particular one charges each condenser once per revolution of a small fan motor worked off the 230 volt supply. When running at 3,000 R.P.M., the interval between charging any condenser is nearly 0.02 second, as stated above.

The shaft of the motor bears a small insulating disc to which are fastened two rotating brushes and a balance weight to prevent vibration. The brushes consist of a number of phosphor bronze strips as used for rotary switches, bent over by a stiff piece of metal and bolted to the end of a metal arm as shown in Fig. 2. One arm has a contact stud screwed to it which makes contact with a fixed brush connected to one side of the input. The other supply line is connected through another fixed brush bearing on the motor shaft and through a screw fixing the second rotating brush to the small pulley or other metal disc attached to the shaft. Care must be taken to prevent the two rotary brushes or their connections making contact anywhere, for obvious reasons. To limit the current, in the event of a short circuit developing in the machine, a resistance of about 15 ohms is connected in one of the leads, preferably in the one not earthed. This passes enough current to blow the fuse, but prevents the burning up of the contacts, as would happen if a dead short took place.

(Continued on page 624)

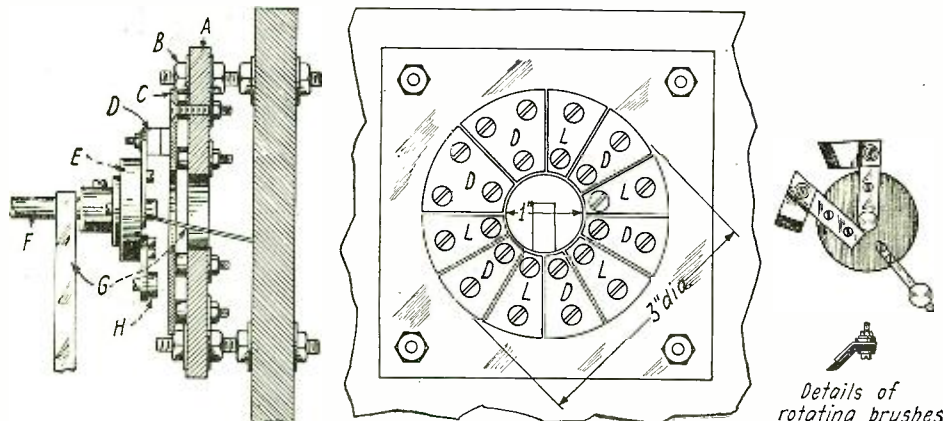

Fig. 2

Constructional Details of the Stationary Contacts and the Movable Brush Contacts That Compose a Portion of the Voltage Raiser.

author, using the machine described below, is heard at a good strength and regularly on a two-valve receiver at Orleans, France.

The machine to be described is an attempt to solve the problem of providing a suitable H.T. supply for a low-power tube transmitter. Most of those who work with transmitters are faced with the difficulty of accomplishing this without considerable expenditure. Such experimenters fall into three groups: those with access to an A.C. supply, those with a D.C. supply, and those with no supply laid on at all. The man who has access to A.C. is usually regarded as being

condensers in series and charging these at frequent intervals from the D.C. supply so as to maintain the voltage.

In Fig. 1 if  $C_1, C_2$ , etc., are a number of condensers and the supply voltage, which will be assumed to be 230, is connected in turn across each condenser, the voltage across AB will be 920. If now AB is connected up to a transmitter, the condensers will discharge through it, and the voltage will gradually fall. To avoid this the condensers are recharged from the mains, and so on rapidly.

It will be seen that however often the condensers are charged, their voltage must drop to some extent in the interval between successive charges if they are supplying current; in other words, the output is not perfectly smooth, but it can be made very nearly smooth by suitably designing the charging device.

The first thing to fix on is the number of condensers in series, which, of course, determines the step-up effect desired. If the supply is at 230 volts, and it is desired to step up to about 900 volts, four banks of condensers should be used. It must be remembered that lower voltages can be easily obtained at any time by connecting the output terminals across only a part of the condensers.

As previously explained, there is a drop in voltage during discharge, so that in practice the output is somewhat less than as indicated above. With a suitably designed machine it is about 90 per cent, so that with four condensers in series the average output voltage is about 830.

To find the size of condensers for a given power, allowing this 10 per cent drop, the fundamental equation for condensers is used

$$C = \frac{Q}{V}$$

where  $C$  is the capacity in farads

and  $Q$  is the quantity of electricity which passes in or out when the voltage is altered by an amount  $V$ . Assuming the flow of

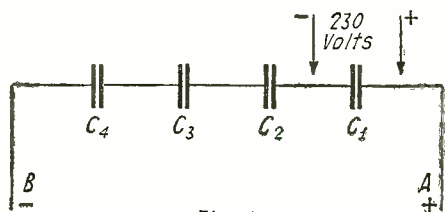

Fig. 1

Each Condenser is Charged Separately from the Power Line, and Discharges Through the Series Bank. A Constant High Voltage is Thereby Maintained.

the most fortunate, owing to the ease with which the supply voltage may be stepped up to any desired extent without the use of rotating machinery of any sort. The disadvantage lies chiefly in the rectifier, of which it may be said that no really satisfactory type is available; chemical rectifiers are uncertain, and their efficiency depends on a great many details being carefully attended to; valve rectifiers are expensive to equip and run, and may burn out. Further, elaborate smoothing circuits are usually essential.

The D.C. man is well off where only a very small power of, say, 3 or 4 watts is required, as he can run his tubes off the mains at no expense whatever for H.T. supply, and little or no smoothing is required, even for telephony. As domestic supplies

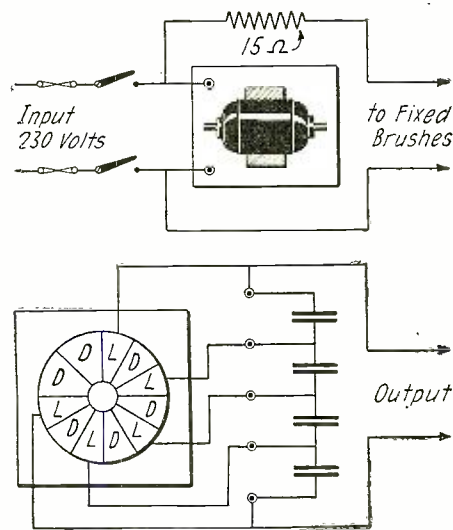

Fig. 3

Showing the Method of Connecting Up the Entire Unit. Be Sure the Condensers Are of Good Construction, and Will Withstand the Strain Placed Upon Them.

# The Static Frequency Multiplier

## For the Industrial Production of Very High-Frequency Currents In Radio Telegraphy

By MARIUS LATOUR, M.I.R.E.

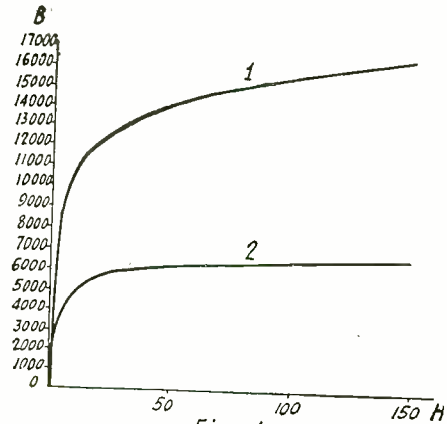

Fig. 1  
Curves of Magnetism for 1 Silicon Steel and 2 Nickel Steel (Alloy Y)

It is now possible to obtain directly and efficiently, by means of high-frequency alternators, currents having frequencies of 30,000 to 40,000 cycles per second. In order to do so, it is preferable to use either ordinary homopolar alternators having the great peripheral speed of 250 meters per second or homopolar machines with reduced number of stator slots as previously described by the author\* and having the relatively low peripheral speed of 150 meters per second.

By admitting greater peripheral speed even for alternators having a reduced number of stator slots, it is possible to attain a frequency of between 50,000 and 60,000 cycles per second; but it does not seem possible to industrially realize, under efficient mechanical and electrical conditions, higher frequencies directly by means of high-frequency alternators. It is, however, indispensable to obtain such higher frequencies and particularly for outputs of from 5 to 20 kilowatts, if we want dynamo-electrical generators to compete with thermionic tube generators which are rapidly evolving.

It was with this object in view that the author, several years ago, interested himself in static frequency multipliers, the operation of which depends, as is well known, on

the phenomenon of magnetic saturation.

Before undertaking the construction of such apparatus the author preferred seeking a magnetic substance which would be more suitable to this application than either iron or silicon-iron.

To begin with, the author first proposed in French Patent No. 491,184 of May, 1915, the use, in frequency multipliers, of magnetic substances such as nickel which possess a magnetic curve similar to that of iron, but on a scale reduced along the induction axis. These substances, in which the saturation phenomenon occurs at lower inductions than in iron, afford the possibility of turning this phenomenon into account by resorting to much smaller magnetic induction variations than with iron. These induction variations then become more compatible with the high frequency in question from the point of view of losses. Since then, the author has carried out investigations in order to determine such a substance, in the nickel-steel series, possessing at the same time a small hysteresis coefficient and a great resistivity whilst being sufficiently malleable to be laminated into sheets of 0.05 to 0.06 mm. thick. (See French Patent No. 510,462 of May, 1919).

In May, 1920, Mr. Guillaume, having confirmed certain data, it was possible to obtain, with the co-operation of the Imply Steel Works, a very interesting alloy which we shall hereafter refer to as the Y alloy.

The 0.05 to 0.06 mm. sheets of this alloy were compared to the best sheets of equally thick silicon-iron, which could be produced for frequency multipliers. The measurements were carried out at the Laboratoire Central d'Electricité under the direction of Mr. Jouaust. The alloy in question was tested at a temperature of 100° C. The results of the comparison are as follows:

**Magnetic Curve**—Fig. 1 shows both the silicon-iron magnetic curve I and the Y alloy curve II. It may be at once noted that the Y alloy curve is much the same as that of the silicon-iron reduced to 0.4 along its induction axis. The sample of silicon-iron sheets under test presents this peculiarity, however, of being relatively little permeable at high inductions.

**Hysteresis**—The author already pointed

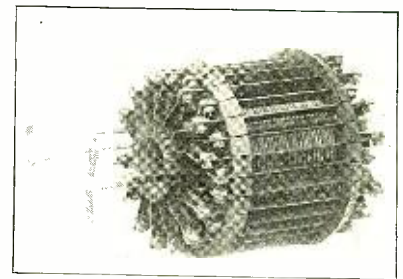
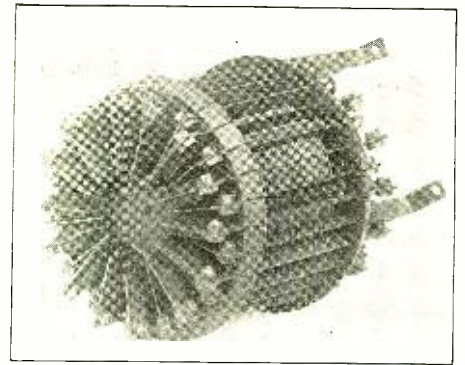

Front and Back Views of a Frequency Multiplier of the Latour Type.

out (See Radio Review of August, 1920) that the laminating of these substances into sheets as thin as 0.05 to 0.06 mm., appreciably increases their hysteresis. The hysteresis coefficient of the 0.05 to 0.06 mm., silicon-iron sample, the magnetic curve of which is shown in Fig. 1, is nevertheless but 0.0014 for an induction of 2,600 gauss and 0.0026 for an induction of 17,600 gauss. In view of the thinness of the sheets in question these figures must be regarded as being very low. It occurs, however, that the hysteresis coefficient of the 0.05 to 0.06 mm., Y alloy is more advantageous since it is 0.0014 for an induction of 7,000 gauss at which this alloy is saturated.

**Resistivity**—The difficulties of laminating iron having a large amount of silicon, into very thin sheets, are well known. The silicon-iron resistivity for the sample under test is nevertheless 45 microhms-cms., i.e., 50 per cent higher than that of the best sheets actually available on the market. Now, the Y alloy resistivity is still higher, being 85 microhms-centimeters.

Hence, the superiority of the Y alloy sheets over the best silicon-iron sheets, inasmuch as frequency multiplier applications are concerned, is considerable. These Y alloy sheets permit of a much higher efficiency at very high frequencies; as a consequence we may avoid the complications inherent to frequency multipliers necessitated for the evacuation of the excessive quantity of heat generated therein.

The losses per cubic centimeter may be calculated by means of the author's formula (See Revue Générale d'Electricité, April 13, 1918). As a matter of fact, it is only at a frequency of about 100,000 cycles per second that the value of the eddy-current losses reaches that of the hysteresis losses and this for an induction corresponding to saturation.

By using the Y alloy, it has been possible to realize the trebling and quintupling of a frequency of 33,000 cycles per second without using any direct current and with a very easy cooling of the multiplier.

(Continued on page 640)

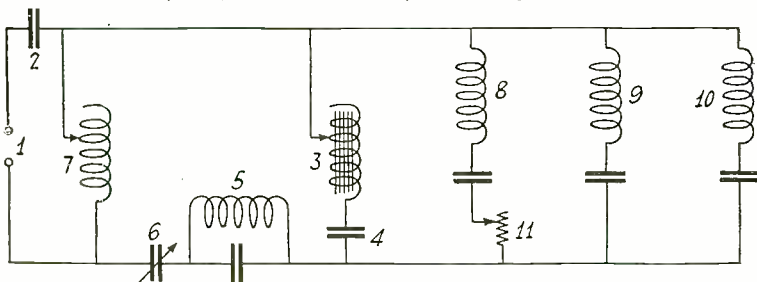

Fig. 2

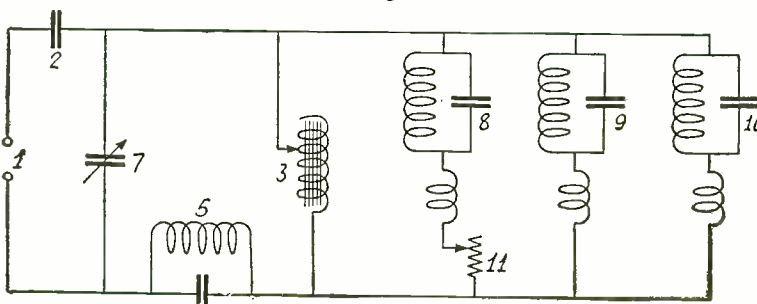

Fig. 2-A

Two Circuits Utilizing the Frequency Multiplier. 1 Alternator, 2 Compounding Capacity, 3 Multiplier, 4 Stabilizing Capacity, 5 Trap Tuned for Multiple Frequency, 6 Variable Condenser, 7 Variable Inductance, 8, 9 and 10 Resonant Circuits, 11 Output Resistance.

\*See the author's U. S. Patent No. 1,234,914.

# Continuous Wave and Radiophone Transmitters

By L. R. FELDER

Part II.

**I**N the introductory article of this series we considered the theory of the generation of continuous waves by means of vacuum tubes and showed how a simple miniature transmitter could be made of any regenerative receiving set. In this article we will go one step further and take up the subject of designing a lower power 5-watt C.W. transmitter.

In a low power outfit of this description it is desirable to make it as simple as possible, and to this end the more elaborate and complicated circuits are not desirable; the circuit should have as few parts as is con-

sistent with good performance. There are a number of very simple circuits which are particularly suitable for such sets and in this discussion we will describe two such circuits. Before going into the details it is desirable to discuss the question of the power supply, namely what power is suitable for the filament and plate.

If A.C. is decided on there is the question of the filament transformer. This may either be made or purchased outright. Unless one has facilities for building a transformer it is questionable whether anything is gained by building rather than by purchasing. Many amateurs have the queer notion that anything made is always better than anything bought. This is not so. What counts is the result, and the man who spends \$10.00 for a real good filament transformer and gets action is much better off (and incidentally a better amateur) than the so-called amateur who sweats trying to "make" a transformer and gets no results. This does not mean that all home made transformers are not good. If you have the facilities and are a good mechanic there is no reason why you should not make a good transformer, but there are some very excellent and high grade filament transformers now on the market which are just suitable for the set here mentioned.

When it comes to the plate power supply for low power tubes there are three sources of power: (1) A bank of large "B" Batteries. With UV-202 tubes it is possible to string up a bank of large plate batteries up to, say, 300 or 350 volts, and get pretty good results. If you do not use your set too much this may prove a very simple way of obtaining a non-fluctuating source of D.C. (2) High voltage D.C. generator. This is the ideal source of supply and the most desirable. If you can afford it, it is worth while. (3) Rectified A.C. This necessitates the use of a step-up transformer, and the use of the necessary filter circuits and rectifying devices which are very expensive. The subject of filters has been so thoroughly developed that it is possible to use rectified A.C. and get practically as good

results as with a D.C. generator. Which to use is a question of cost. The amateur must figure out for himself item for item the cost of the D.C. generator and accessories and compare against the cost of the step-up transformer, rectifying units and filter devices. The writer believes that in the long run the cost will be about the same for one as for the other. Straight D.C. is preferable if you can get it. On the other hand rectified A.C. has a great advantage. You can buy your step-up transformer (or build it) so that it has a variable step-up ratio, and thus get a wide range of voltages which may

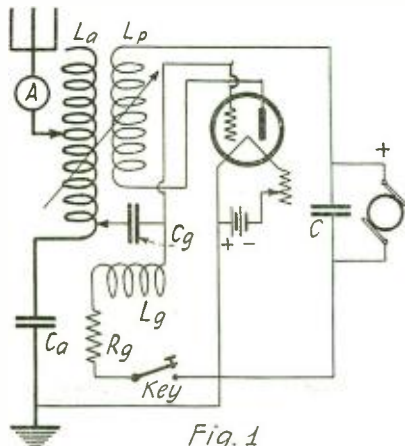
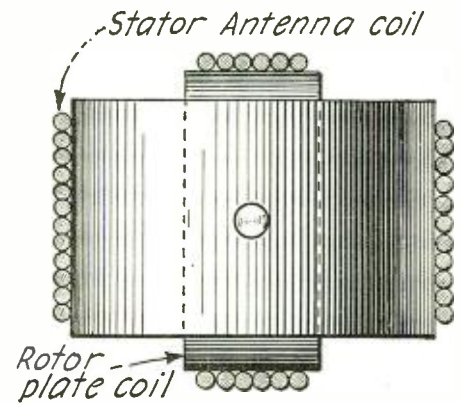

Fig. 1

Circuit of a Low Power C.W. Transmitter  
La, 25 Turns. Lp, 50 Turns. Ca, .0003 M.F. Cg, .002 M.F., C, 1.0 M.F., Rg, 5000 Ohms. Lg, L200 H. C. Coil.



The Two Coils May Be Mounted Variometer Fashion.

later come in handy for higher power tubes. D.C. generators are generally built for a definite voltage, and thus lack the flexibility of transformers. You pay more money and pick whichever you think more suitable for your purposes. The question of building a right rectifier and filter circuit will be left to a later article when it can be taken up more in detail. We will therefore assume in this article that the plate supply is available in one form or another and that direct current voltage is applied to the plate.

The circuit here recommended for a 5-watt set or under is illustrated schematically in Fig. 1, in which complete connections and circuit constants are given. The circuit is an inductively coupled circuit and has just two adjustments: (1) wave-length, by adjusting the number of turns on the antenna coil La, and (2) coupling between the antenna coil La and plate coil Lp. The two coils La and Lp form what is sometimes called the "antenna-plate transformer." This transformer serves a most important function, and this is based on a principle which all amateurs ought to be very well acquainted with. It is the aim of all amateurs to obtain the maximum possible output from their sets at the maximum efficiency, in plain language to get all they can out of the tube. It has been shown by various writers (for example, Professor Powers in a recent issue of RADIO NEWS, on "Matching Impedances") that the maximum output at maximum efficiency is obtained when the load impedance or resistance is equal to the impedance or resistance of the generator. Now in the case of our tube transmitter the generator is the vacuum tubes, whose impedance is the impedance of the plate to filament path, which may be about 5000 ohms for a UV-202. The load is the antenna resistance which may be of the order of 8 to 16 ohms. It is obvious that we could never

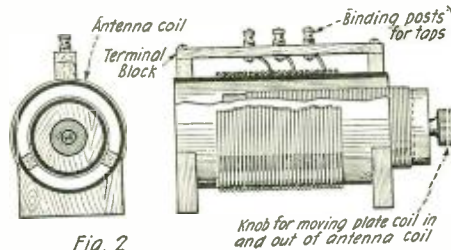

Fig. 2

A Practical Mounting for the Inductances. The Plate Coil Slides Inside the Antenna Coil

(Continued on page 641)

# Audio Frequency Transformers

By CLYDE J. FITCH

**Q**UALITY in radio music depends largely upon the characteristics of the audio frequency amplifying transformers employed. It is usually the amplifying transformers that determine whether the received programs will be music or noise, and in order to aid purchasers in selecting efficient transformers and also help manufacturers in designing them, this article has been prepared. After making extensive tests on some two dozen different types of audio transformers now on the market, the writer came to the conclusion that there are very few really efficient ones and that the best have possibilities of great improvement.

The difficulty involved in designing an efficient audio frequency transformer is to produce one that will function equally as well on one frequency as on another. Unlike power transformers designed for operation on one frequency only, an amplifying transformer is subjected to a wide range of frequencies, from the lowest notes of the saxophone to the highest notes of the piccolo. Hence, it is no easy matter to construct a transformer that will give high and uniform voltage amplification over the above wide range of frequencies. If the transformer is not as efficient on the lower notes as on the higher, the higher notes will be amplified to a much greater extent than the lower ones, and the quality of the amplified music or speech impaired. Distortion

Constructional Details of Various Types of Audio Frequency Transformers. Fig. 4 Shows a Home-Made Transformer Which Gives Good Results.

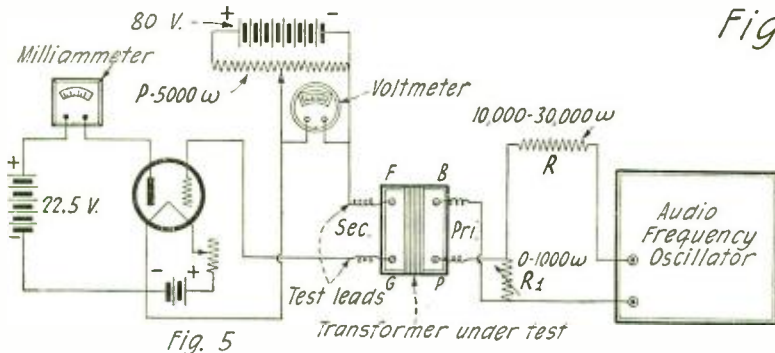
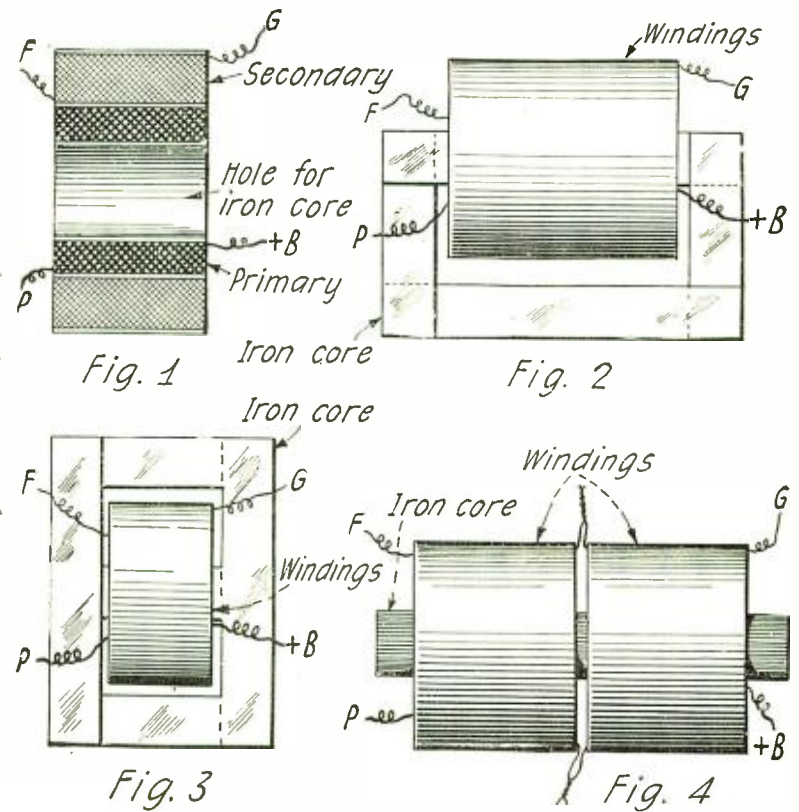

Circuit Used for Testing Transformers.

that had no iron core. Just the two coils were employed, which were necessarily large due to the absence of the iron core, but this type of transformer has been discarded as inefficient and costly.

The iron core is made up of many thin pieces of soft iron. It offers a low resistance path for the magnetic lines of force set up around the coils when in use. The best silicon steel should be used for the core and the thinner the laminations the better in order to reduce hysteresis and eddy current losses. The majority of transformers employ a core having a cross-sectional area of  $\frac{1}{2} \times \frac{1}{2}$ ". Some have larger cores. Figs. 2 and 3 show two types of transformers with cores assembled. The iron laminations are interleaved, dove-tail fashion at the corners, to make good magnetic joints. There are only a few constructed according to Fig. 2 now on the market, but this type is as good as the other if properly designed. The cores of course are clamped between insulating pieces on which the binding posts

(Continued on page 633)

will be introduced, with no possibility of correction unless better transformers are employed.

Most manufacturers employ the cut and try method in the design of amplifying transformers until an efficient one is obtained. Of course it is well known that the transformer should match the vacuum tubes employed with it; that is, the impedance of the primary coil should equal the plate to filament impedance of the tube, and the impedance of the secondary coil should equal the grid to filament impedance of the tube. But as the impedances of the transformer varies considerably with the frequency, and as the impedances of the tubes vary with their adjustments, these conditions are only satisfied approximately. They do not mean much and do not always hold true. Only a general idea of the approximate number of turns and size of core can be obtained.

Fig. 1 shows the arrangement of the coils in all of the present day transformers. The primary coil is inside and comprises from 2000 to 3000 turns of fine wire, about No. 40 B. & S. gauge. The secondary coil comprises from 3 to 10 times as many turns of about the same size wire, hence it is evident that it is useless to attempt to wind one by hand. In this illustration, and also in the others, the terminals are marked to correspond with the vacuum tube connections, which arrangement, through years of experimenting, has been found the best. It will be noted that the outside end of the

secondary winding should connect to the grid of the tube. This is to avoid the condenser effect between the grid and the primary coil, which would exist if the grid was connected to the inside of the secondary coil adjacent to the primary coil.

The next important part of the transformer is the iron core. The transformer consists of three parts: primary coil, secondary coil and iron core. At one time there was an audio transformer on the market

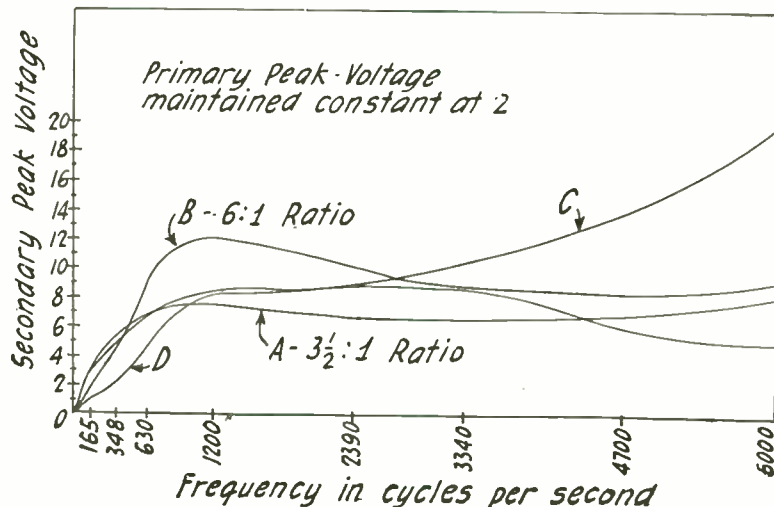

Amplification Curves of Various Audio Frequency Transformers, Showing Relative Efficiency.

# A High Frequency Alternator for Tone Modulation

By K. KENNETHÉ

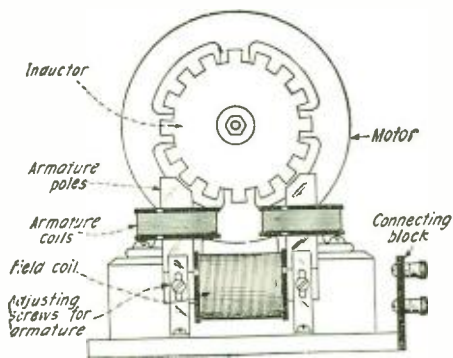

Fig. 1 A

A Small Inductor Alternator for Generating Currents of 500 to 1,000 Cycles.

A SMALL alternator generating currents of frequencies from 500 to 1000 cycles per second provides an excellent means for modulating the output of a C.W. or radiophone transmitter for I.C.W. or tone telegraphy. The following article describes the construction and use of a small alternator of the inductor type designed for this purpose, which can be constructed in a short time from materials usually on hand. Unnecessary dimensions and data have been omitted from this description, and constructional details have been made as general as possible.

As shown in the illustration, Fig. 1, (A), the alternator consists, essentially, of a stationary armature on which are wound the field and armature coils of the alternator, and a toothed inductor or rotor mounted on the shaft of a small motor. Briefly the theory of the operation of the device is as follows:

As the inductor rotates, the reluctance of the magnetic circuit through the inductor and armature core is varied periodically from maximum to minimum, due to the variations in the length of the air gap between the inductor and the poles of the armature as the projections on the inductor

pass the armature poles. This produces a corresponding variation in the flux linking the armature windings, generating an E.M.F. in the armature windings, the frequency of which is equal to the number of projections on the inductor multiplied by the revolutions per second.

The armature or core on which the field and armature coils are wound should be built up of laminations of transformer steel. The cross-sectional area of the core need not be greater than 1 square inch, the other dimensions of the core being sufficient to allow space for the field and armature windings, the positions of which are as indicated in Fig. 1, (A). The ends of the core should project at least an inch above the armature coils to form the poles of the armature.

A very convenient method of mounting the armature is shown in the illustration, for with this mounting the laminations are clamped firmly together, while the slots in the legs supporting the armature permit it to be adjusted so that the length of the air gap between the armature poles and the corresponding teeth on the inductor can be reduced to a minimum; a condition essential to the proper operation of the alternator. The importance of this detail should not be overlooked, since the length of this gap is one of the factors determining the output of the alternator and for maximum results the length of the gap should be reduced as much as possible, being just sufficient to allow the teeth on the inductor to clear the pole faces of the armature.

The inductor or rotor of the alternator may be constructed from the laminations taken from the armature of a motor or generator, or it can be made from an old gear. In either case, the teeth or projections on the inductor should be so spaced that they are separated by a distance slightly greater than the length of one of the pole faces of the armature. While not essential, a much better wave form will be secured if the teeth on the inductor are shaped so that the length of the face of each tooth will be much less than the length of the base, the length of each side of the tooth being

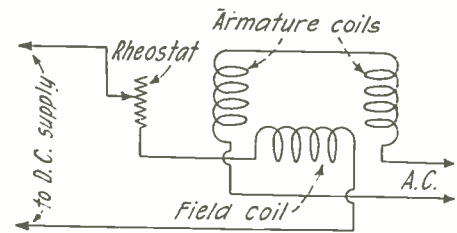

Fig. 1 B

A Diagram of Connections of the Alternator

equal. This will make the tooth triangular in shape. The inductor should be of approximately the same width as the armature and should be mounted directly on the shaft of the motor driving the alternator.

The design of the armature and field windings is governed largely by the voltage of the D.C. source employed to excite the field. Ordinarily, the field winding may be of No. 20 to 26 S.C.C. copper wire, the number of turns in the winding depending on the voltage of the source from which the field is to be excited. If this is a 6-volt storage battery, from 200 to 400 turns can be used in the field winding, and the same can be used satisfactorily for higher voltages, providing sufficient resistance is included in the field circuit to keep the current through the winding below 1 ampere. The field coil is best wound directly on the armature core, adequate insulation being placed between the winding and the armature, and end pieces of insulating material placed at each end of the coil.

Since the output of the alternator is not very great, the current in the armature coils will be relatively small, and small, enameled, copper wire can be used for winding the armature coils. The number of turns in each of the coils should be several times the number of turns in the field winding, and the two coils should be connected together so that the voltages generated in each will add. This connection is best determined by experiment.

(Continued on page 635)

## Throw Those Taps Away

By BERT T. BONAVENTURE

WHY designers of radio sets insist on having a set of switch taps to adorn the face of a panel is not a difficult question to answer. Their reply would be somewhat as follows:

Since it is desirable to get as large a voltage drop across the coil as possible, to better actuate the detector, the ratio of inductance to capacity should be as large as possible, within limits of course. Further, since this condition is to hold true over a band of wave-lengths, it will be necessary to provide some means whereby the above-mentioned desirable ratio may be always attainable. With taps on the coil, a method is obtained for changing the wave-length quickly, easily and efficiently.

To this we may answer:

Very true indeed. We grant that the ease and rapidity of wave-length control is a valuable feature of the tapped coil system, but we question the point with regard to efficiency. We shall submit the necessary data herewith to substantiate our contention and we shall advocate another means of wave-length control which is much more efficient, although there is nothing new about the method. In fact, it is in daily

use on hundreds of sets. What we wish to do is merely to bring the attention of builders and designers to bear on the subject and to have the method universally adopted on all sets where it is applicable. What we advocate is the use of untapped coils, properly designed, which are tuned by means of small variable condensers (0.00025 mfd.) For antenna circuits the condenser should be larger, in the order of 1,000 micro-microfarads (0.001 mfd.). Fig. 1 illustrates the point in question.

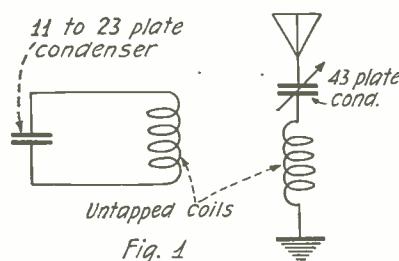

Fig. 1

Circuits Composing Untapped Coils, Being Tuned by Means of Variable Capacities. The Condenser in the Shunt Circuit Illustrated Should be Variable.

In passing, it may be well to point out that the use of Litzendraht wire for wave-lengths lower than 300 meters will not be as efficient as solid wire of relatively large cross-sectional area. Litzendraht wire is more suitable for the longer wave-lengths, especially where the coil is bank-wound.

From the mechanical point of view, several objectionable features exist in the tapped coil system. First, the taps themselves must be taken off the winding of the coil. This is done by either looping and twisting the wire at the spot where the tap is to be made, by soldering a lug at the desired place, at which the insulating cover has been scraped to allow the soldering to be done or else by drilling holes in the tubing where the tap comes off and threading the wire through in such a manner that it will not loosen. The foregoing tedious explanation is a fair picture of the actual job itself.

After the taps have been taken on the coil, they must be carried to the switch contacts, involving more soldering and wiring. Before the switch contacts can be put in place, the panel must be drilled to

(Continued on page 636)



**WIRELESS RECEIVING SYSTEM**

(Patent No. 1,455,767. Issued to Joseph Slepian, Swissvale, Pa., May 15, 1923.)

The principal object of this invention is to provide an improved wireless receiving system, wherein received signal impulses are enormously amplified, and a system wherein undamped, continuous wave-signal impulses may be readily received without the customary heterodyning step heretofore employed. According to the invention, signal impulses to be detected are impressed upon a regenerative feed-back system, adjusted to what heretofore has been considered an un-

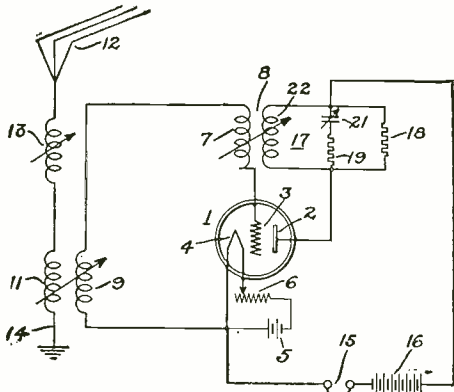

desirable state—that is to say, one in which an increase of the amplitude of the oscillations caused a more than proportional increase in the feed-back power, tending to maintain the oscillations continuously. The unbalanced condition of the system, which is effective following the application of the signal impulses, is made stable at pre-determined time intervals thereafter by means of thermally responsive elements, having a time lag in their responses. The maximum amplitude attained by the oscillations at the end of said time lag is dependent upon the intensity of the impulses, tending to unbalance the system. The single figure is a diagrammatic view of a wireless receiving system, embodying this invention.

**TELEPHONE HEAD SET**

(Patent No. 1,447,969. Issued to Frederick Dietrich, of Flushing, N. Y., Assigned to C. Brandes, Inc., of New York, N. Y., March 13, 1923.)

This invention is directed to improvements in telephone headsets and has among its objects the provision of a device whereby the user of the headset may easily and quickly adjust the receivers to his ears; the provision of a simple

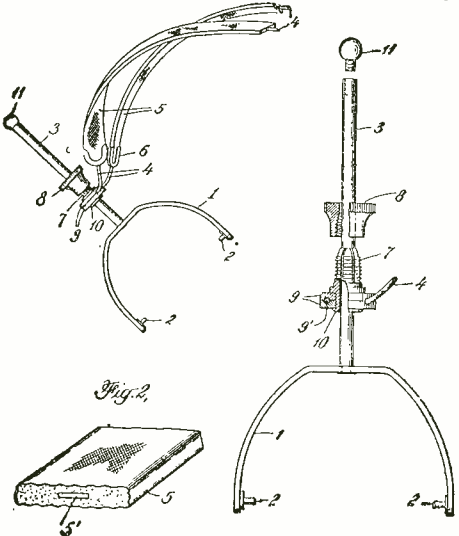

but dependable arrangement for securing the aforementioned device to the headband; and an improvement in the padding of the headband by the elimination of seams which practical experience has shown have a tendency to rip open

due, it is believed, to the action of perspiration or oil from the hair of the user on the stitching.

One of the principal features of the invention relates to the device before mentioned for adjusting the receivers to the ears of the user. This device is preferably in the form of a collet chuck having a concentric aperture in which a rod forming a part of a receiver supporting member is slidably and rotatably mounted. By means of an adjusting nut having a tapered thread engaging the collet, the latter may be contracted to securely grip the rod, and thus when the receivers are adjusted to the satisfaction of the user he may, by simply turning the adjusting nut, fasten them in that position. This device, as will be seen, engages the rod on practically its complete circumference and its design is such that a powerful gripping action is obtained even with a relatively slight turn of the nut.

**VARIOMETER**

(Patent No. 1,456,267. Issued to Harold Potter Donle, of Meriden, Conn., May 22, 1923.)

The main object of my invention is to provide a variable inductive apparatus characterized by a considerable range and ease of adjustment of inductance values, relatively small and constant electrical resistance, and low distributed capacity. Another object is to make such a device compact, simple, light yet durable, and at a relatively low cost. When used for instance in a radio receiver, my device accommodates a large range of wave-lengths, provides simple tuning adjustments with small electrical losses. I have shown it in a form which is easily portable, and although economically made, it is durable.

Inside of the box are mounted a plurality of coil members, at least one of which is stationary, and at least one of which is rotatable. In the form shown there are two of these coil mem-

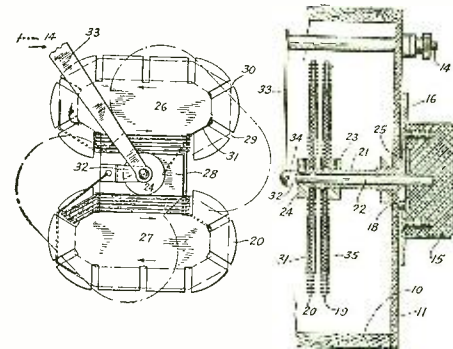

bers 19 and 20. The coil member 19 is carried by a sleeve 21 which projects rearwardly from the cover or front plate of the box, and the coil member 20 is carried by the spindle 22 which is secured to the operating knob 15. The sleeve 21 is stationary and the coil member 19 may be secured to it in a suitable manner, for instance, by means of a metal hub 23 and set screw. Similarly the coil member 20 may be secured to the shaft 22 by a hub 24 and set screw so that the coil members may be readily attached or adjusted on their respective supports. I may also provide a resilient washer 25 in the back of the operating knob to hold the hub 24 in yielding contact with the end of the sleeve 21. It will be seen that the two coil members may be adjusted closer together or further apart by simply sliding the hub 23 and its coil member along the sleeve 21, and then securing it in place by the set screw. By making the spacing between the two coil members as small as is mechanically feasible, the ratio of maximum inductance to minimum inductance, or, in other words, the range of the instrument is made extremely large.

The coil members may be all identical and each may consist of a single length of wire especially wound so as to provide two oppositely disposed polygonal parts. In this form, each part is spirally wound on a slotted support so that short lengths zig zag back and forth, first on one side and then on the other side of the support, adjacent turns crossing each other in the slots at intervals. The two parts are so wound and connected that the current travels in them in opposite directions. Preferably, the supporting part of each coil member is formed of a plate of insulating material having a central arm 28 and two extended heads 26 and 27 on opposite ends of the arm.

**MULTI-STAGE AMPLIFIER CIRCUITS**

(Patent No. 1,459,419. Issued to Edward O. Scriven, of New York, N. Y., June 19, 1923.)

This invention relates to multi-stage amplifier circuits and more particularly it relates to vacuum tube circuits wherein a plurality of repeaters or amplifiers are employed to amplify signals impressed thereon from an incoming line.

One of the objects of this invention is to provide a means for regulating the degree of amplification of a multi-stage amplifier set for signals impressed thereon.

As is well known in the art, weak currents or signals may be amplified to any desired degree by impressing them on a plurality of vacuum tube amplifiers arranged to work into each other by suitable circuit connections. In employing such a multi-stage amplifier set for amplifying weak currents, it is frequently found undesirable

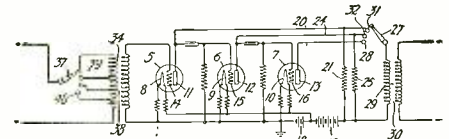

to use the total amplification of the set before impressing the amplified currents on the outgoing line or the receiving instrument, since the degree of amplification desired for each particular case will depend largely upon the strength of the incoming currents and on the electrical conditions in the output circuit into which the amplifiers work. It is also frequently desirable to cut down the degree of amplification to prevent overloading the last stages.

In accordance with this invention, a single switching means is employed to cut in or out one or more of the plurality of the amplifiers so as to regulate the amount of amplification for any given case. An additional switch is also provided for regulating the strength of the currents impressed on the first tube so that by operating both switches any desired degree of amplification from the set may be obtained.

**COMBINED RHEOSTAT AND SOCKET**

(Patent No. 1,451,024. Issued to Conrad Klemmer and Welter P. Koehler, of Bogota, N. J., April 10, 1923.)

This invention relates to a combined socket and rheostat unit and more particularly to a novel and improved device adapted particularly to be mounted on the panel of a radio outfit without resorting to the use of separate fastening elements or mountings.

The primary object of the invention is the provision of a vacuum bulb or tube holding socket which is connected to an insulated block or support so that it combines with the same to com-

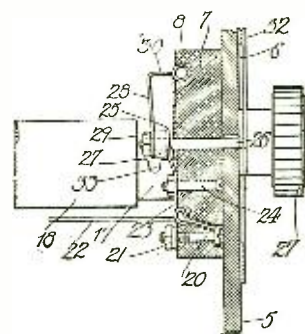

prise a unit whereby the same is attachable to a panel and arranged so that the conductors leading to the positive and negative filaments may be easily connected as is common in various types of radio receiving outfits.

**RECEIVING ARRANGEMENT FOR WIRELESS TELEGRAPHY**

(Patent No. 1,454,328. Issued to Alexander Meissner, of Berlin, Germany, May 8, 1923.)

The object of the present invention is an improvement on the wireless telegraph receiving arrangements disclosed in German Patent 352,581.

In accordance with the main patent, a cathode relay is actuated by means of an alternating current generator at the receiving station, whereby the received high frequency energy is at the

(Continued on page 584)



## Apparatus Awarded Certificates

### NOTICE

Mr. Louis Gerard Pacent, Director of RADIO NEWS Laboratories, resigned August 6, 1923.

Due to Mr. Pacent's large interests, it was impossible for him to give sufficient time to the ever increasing work of RADIO NEWS Laboratories.

H. GERNSBACK.

### FIVE CIRCUIT SWITCH PLUG

A five circuit switch plug designed to accommodate either a head-set and loud speaker or two head-sets is shown in the illustration. This plug is manufactured by



George E. Walker Co., St. Louis, Mo. An ingenious switching arrangement operated by turning the plug connects in either the phones or loud talker independently, or the two in parallel or in series or disconnects them both from the receiving set. The insulating material is of bakelite. The plug is not much larger than the ordinary telephone plug. The phone cords may be anchored to a metal ring inside, so that jerking the cords will not pull on the tips. This plug is of very good mechanical construction and of neat appearance.

AWARDED THE RADIO NEWS LABORATORIES CERTIFICATE OF MERIT NO. 243.

### COLE AUDIO FREQUENCY TRANSFORMER

This amplifying transformer, which is manufactured by A. B. Cole, Inc. of 88



E. Kinney Street, Newark, N. J. is hermetically sealed in an aluminum case, making the instrument moisture proof and immune from mechanical injury. The four terminals are brought out through a bakelite top, as shown in the illustration. The characteristic curve is very uniform throughout the wide range of frequencies encountered in broadcast reception, and a high degree of voltage amplification is obtained.

Arrived in excellent packing.  
AWARDED THE RADIO NEWS LABORATORIES CERTIFICATE OF MERIT NO. 228.

### GILFILLAN DIALS

Gilfillan Bros., Inc. submitted two dials, type R.175, 2 1/4" black, and type R.150 3" brown bakelite, one of which is shown in the illustration. They are mechanically accurate and of pleasing appearance. The graduations are in white and show up very distinctly. The set screws, for clamping the dials to shafts, are threaded in metal

inserts imbedded in the bakelite mould. Both are for 3/16" shafts, although this company also makes them for 1/4" shafts.



Arrived in excellent packing.  
AWARDED THE RADIO NEWS LABORATORIES CERTIFICATE OF MERIT NO. 235.

### GILFILLAN CONDENSER

A variable condenser of simple yet accurate mechanical construction and of high electrical efficiency is shown in the illustration. Moulded bakelite end plates support the condenser elements. The shaft turns in metal bearings imbedded in the bakelite forms. A capacity range of from 15.66 to

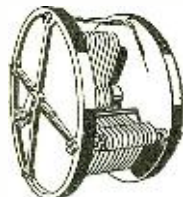

700.71 M.M.F. and a dielectric loss resistance of 240 ohms were obtained. This is a 23-plate condenser, type R.375, manufactured by Gilfillan Bros., Inc. of 1815-25 W. 16th Street, Los Angeles, Cal.

Arrived in excellent packing.  
AWARDED THE RADIO NEWS LABORATORIES CERTIFICATE OF MERIT NO. 229.

### GILFILLAN POTENTIOMETER

This potentiometer, type R.700, is of very durable construction and neat appearance. A moulded bakelite form supports the resistance element and contact arm. Phosphor bronze springs insure excellent electrical contact. The instrument is only 2 1/4" in diameter, the same size as this company's



rheostat, and has a resistance of 190 ohms. Arrived in excellent packing.

AWARDED THE RADIO NEWS LABORATORIES CERTIFICATE OF MERIT NO. 230.

### GILFILLAN VERNIER RHEOSTAT

A vernier rheostat of novel design and employing only one control shaft and dial for operating both rheostat and vernier is shown in the illustration. This instrument is also manufactured by Gilfillan Bros., Inc.,

and is known as its type R.800 vernier rheostat. As shown in the illustration, a resistance wire passes around the outside of the moulded bakelite form and provides for the vernier adjustment. Two contact arms are employed, but only the outside or vernier arm is rigidly secured to the shaft. This arm, after rotating through an angle

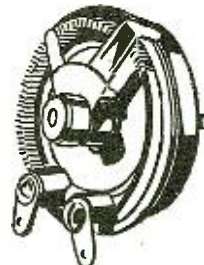

of 90 degrees, catches on to the rheostat arm and pulls it around. Thus the rheostat arm can be moved forward or backward only after rotating the vernier arm 90 degrees.

Arrived in excellent packing.  
AWARDED THE RADIO NEWS LABORATORIES CERTIFICATE OF MERIT NO. 231.

### GILFILLAN DETECTOR UNIT ASSEMBLY

Simplicity in building and wiring radio receiving sets may be obtained by using this type R.475 detector unit assembly, which is manufactured by Gilfillan Bros., Inc. This device is of moulded bakelite construction and is very rugged. It comprises a filament rheostat, vacuum tube socket, and fixed grid



and by-pass condensers, which are enclosed in a case underneath the socket. Terminals are provided for all of the above instruments, so that they may be adapted to any circuit. Space for mounting an amplifying transformer is also provided behind the socket.

Arrived in excellent packing.  
AWARDED THE RADIO NEWS LABORATORIES CERTIFICATE OF MERIT NO. 232.

### GILFILLAN MODEL NO. 2 VARIO-COUPLER

A small sized vario-coupler of excellent mechanical and electrical construction is shown in the illustration. This instrument



is only 4" high and the primary coil 3" in diameter, and is arranged for both panel and base mounting. The form is of brown bakelite. Excellent results were obtained on both amateur and broadcast reception. The



bearings are mechanically accurate and insure good electrical contact with the 3/16" shaft which makes connections with the inside rotor coil. This vario-coupler, type R.650, is also manufactured by Gilfillan Bros., Inc.

Arrived in excellent packing.  
AWARDED THE RADIO NEWS LABORATORIES CERTIFICATE OF MERIT NO. 233.

**GILFILLAN MODEL NO. 1 VARIOMETER**

As shown in the illustration, this variometer is of excellent electrical and mechanical construction and is arranged for both

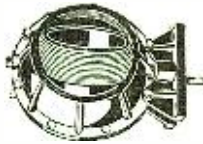

panel and base mounting by simply shifting the location of the bakelite mounting brackets. This variometer is manufactured by Gilfillan Bros., Inc., and when connected in series with the secondary winding of the Model No. 2 Variocoupler, a range of from 140 to 450 meters was covered. This instrument is of the standard size and of the usual design.

Arrived in excellent packing.  
AWARDED THE RADIO NEWS LABORATORIES CERTIFICATE OF MERIT NO. 234.

**FEDERAL NO. 65 AUDIO FREQUENCY TRANSFORMER**

For maximum efficiency in the amplification of orchestral music and speech the Federal Telephone and Telegraph Co. of Buffalo, N. Y. have produced the amplifying transformer shown in the illustration.

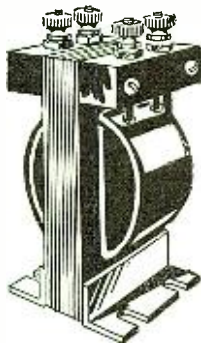

This instrument is larger and of more rugged construction than this company's former type; the windings are shielded and entirely protected from mechanical injury. Exceptionally high and uniform voltage amplification was obtained throughout a range of frequencies from 300 to 6,000 cycles per second, and fair amplification beyond these limits. This transformer is ideal for use in broadcast reception where a minimum of distortion is desired.

Arrived in excellent packing.  
AWARDED THE RADIO NEWS LABORATORIES CERTIFICATE OF MERIT NO. 227.

**CAMEO GRAND HEAD-SET**

The Cameo Grand head-phones are manu-



factured by the Cannon and Miller Co., Inc., of Springwater, N. Y. The phones are of the standard 2-pole construction em-

ploying 2 1/8" iron diaphragms. The shells are of aluminum. The headband is of simple construction, easy to adjust, and may be worn with comfort. The cords are marked and the polarity stamped on the phone shells, so as to aid in properly connecting them to a radio set. The resistance is 2,200 ohms and the impedance, at 1,000 cycles, approximately 23,000 ohms. The phones are very sensitive and reproduce with a minimum of distortion.

Arrived in excellent packing.  
AWARDED THE RADIO NEWS LABORATORIES CERTIFICATE OF MERIT NO. 242.

**NATIONAL INTERFERENCE ELIMINATOR**

Interference between two or more stations so often encountered in broadcast reception may be effectively eliminated by properly tuning the receiving set in conjunction with this interference eliminator, which is a wave trap employing a fixed inductance and a variable book type condenser. It is

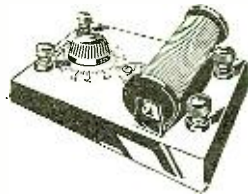

manufactured by the National Airphone Corp., of 20 Hudson St., New York City. With the two inductances furnished with the instrument a range of from 175 to 675 meters is covered, thus making the instrument suitable for eliminating unwanted stations operating on any wave length within that range; hence, the instrument is desirable for use during broadcast reception. This wave trap may be effectively used with any type of receiving set. The green silk covered coils are of very neat appearance.

Arrived in excellent packing, with circular showing different methods of connecting.  
AWARDED THE RADIO NEWS LABORATORIES CERTIFICATE OF MERIT NO. 226.

**RADIOTIVE LOUD TALKER**

Quality as well as quantity seems to be the aim of the Radiotive Corporation of 5317-21 21st Avenue, Brooklyn, N. Y., in producing its loud speaking telephone equipment. The type E loud talker shown in the illustration



faithfully reproduces the wide range of sound frequencies encountered in broadcast reception and is exceptionally accurate on the lower notes, due to the absence of higher harmonies which are inevitably present in many instruments of this nature. The construction is of the balanced armature type, employing a reinforced corrugated non-magnetic diaphragm. The horn is of fibre.

Arrived in excellent packing.  
AWARDED THE RADIO NEWS LABORATORIES CERTIFICATE OF MERIT NO. 236.

**RADIOTIVE PHONOGRAPH ATTACHMENTS**

In order to combine the excellent acoustic properties of the phonograph horn with the life-like tones from the radio set, the Radiotive Corporation has designed two loud speaking phonograph attachments, one



large type F, and one small, type J, one of which is shown in the illustration. The construction of each is similar, employing the same principle as is used in the loud talker described above. Both of these instruments are noted for their excellent quality in addition to being very efficient on both weak and strong signals. Each of these units has an impedance of approximately 18,500 ohms at 1,000 cycles and a resistance of 700 ohms.

Arrived in excellent packing.  
AWARDED THE RADIO NEWS LABORATORIES CERTIFICATE OF MERIT NO. 238.

**RADIOTIVE HEAD-PHONES**

The Radiotive Corporation manufactures also the head-set shown in the illustration. The phones are of the same construction as this company's loud speaking units.



The head-sets are wound for 2,000, 4,000 and 5,000 ohms resistance. The 2,000-ohm head-set, type A, has an impedance at 1,000 cycles of approximately 40,000 ohms. The headband is of simple construction and easy to adjust.

Arrived in excellent packing.  
AWARDED THE RADIO NEWS LABORATORIES CERTIFICATE OF MERIT NO. 239.

**RAULAND ALL-AMERICAN AUDIO TRANSFORMER**

This 3:1 ratio amplifying transformer, type R.12, which is manufactured by the Rauland Manufacturing Company, of 200 N. Jefferson Street, Chicago, Ill., is enclosed in a metal casing, thus shielding and protecting the coils from injury. As shown in the illustration, the transformer is very

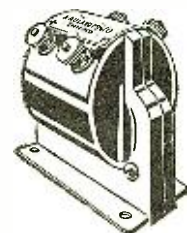

convenient for mounting and wiring in multi-stage sets. It has a flat characteristic curve throughout a wide range of frequencies, making it desirable for use in broadcast reception where distortion is undesirable.

Arrived in excellent packing.  
AWARDED THE RADIO NEWS LABORATORIES CERTIFICATE OF MERIT NO. 240.

# Correspondence from Readers

## A HAM WHAT AM

Editor, RADIO NEWS:

In reply to Mr. S. L. Foster's letter published in the September issue of RADIO NEWS I feel that Mr. Foster's attitude toward the amateur is unjust.

When I first entered into the "radio game," any amateur whom I approached was ready and willing to give me all the information and actual assistance that was possible. No favor was too great.

I have been at several "hams'" homes when one or more B. C. L's. would call for advice of different kinds, or information regarding the building and operation of sets. I have never seen one of them refused; no question was too trivial or ridiculous to be answered and explained in detail. Several times they were asked to bring their sets around and the "ham" would fix them up himself.

As for myself, my phone and door bell are kept busy by B. C. L's. asking for advice or information—and not one has ever been turned down or laughed at because his questions sounded ridiculous.

I feel that any amateur is willing to help the B. C. L's. if asked in the right manner, and be glad of the chance to establish friendly relations between the two factions. I am positive that there are plenty of '9's' around Chicago that will gladly give Mr. Foster a helping hand. I suggest that he try again.

As to the failure of dealers to give a customer satisfaction and the need of a real radio man in their establishments, I heartily agree with Mr. Foster.

WADE C. DURBIN, Radio 8ARE,  
148 Crosby Avenue,  
Brentwood Boro, Pa.

## DX AT SEA

Editor, RADIO NEWS:

While reading a recent issue of RADIO NEWS I noted an article on long distance tests in the Pacific.

It may be of interest to readers to know of long distance work achieved by the "S.S. Ecuador." "WBN."

When "WBN" was on the San Francisco Orient run, "KFS," Federal Telegraph, San Francisco Beach Station, was worked about five hours after the ship left Yokohama eastward bound and during the three weeks voyage to San Francisco via Honolulu KFS and WBN handled traffic without failing to clear each night. This was done during the month of August, one of the worst static months on this run.

Afterward the Ecuador was put on the San Francisco-Baltimore run via the Panama Canal. That winter during a westward bound voyage WBN held nightly communication with NBD, Bar Harbor, on the east coast and KFS, San Francisco, on the west coast, from the first night out of Norfolk until reaching San Francisco. Not a single day was slipped during the entire trip of about three weeks.

While I believe greater distances have been covered I do not believe there is another ship that has ever equalled this record for consistency of the old WBN I have mentioned herein.

The logs of the various stations concerned will substantiate my letter.

My object in writing this letter is to point out the fact that it is one thing to hear stations ranging in power from 150 KW up to 1,000 KW over great distances and still another to work a 5 KW ship arc over the same distance, not only once in a while under perfect conditions, but to do it consistently, not missing a night for an entire voyage.

My personal view is that any ship with equal equipment can accomplish the work of WBN if not surpassing it, if under the direction of a competent operator. How many self-styled operators know how to get the best out of an arc? My answer is one half of one percent.

A. E. R.

## CAN'T THIS BE ARRANGED?

Editor, RADIO NEWS:

An amateur or a phone-hound, which shall it be? If I remain just a broadcast listener, my interest in radio will soon leave me. But as an amateur I would make use of the experimental stage of radio, and my interest would never die out.

After one year of broadcast reception, I have tired of it, to some extent. I would like to join the ranks of the amateur. The fact that I believe the future of radio lies with the amateur, is the reason that I wish to become one of them.

RADIO NEWS has kept me interested as

## Interesting Articles Appearing In November Issue of "PRACTICAL ELECTRICS"

Mercury Vapor Arcs. By Allan R. Kenworthy

Floating Needles and the Magnet. By Dr. Albert Neuburger, Berlin.

Carbon Disc Rheostat.

Finding Positive Pole.

Thermic Telephones Concluded.

Little Known Methods of Producing Electricity. By Raymond B. Wailes.

a broadcast fan. But now it has developed in me the ambition to be a real amateur.

I have become familiar with the international code because of the exercises that were published in the May and June numbers of the RADIO NEWS. I do believe that the RADIO NEWS will convert a great number of the broadcast listeners, into listeners of amateur code, or into amateurs, providing the amateur will help.

Radio cannot save the amateur because he will always exist. But the amateur can and must save radio, because the peak of broadcast listeners will eventually decline, unless they will be able to understand code, and the amateur.

The amateur should devote one night a week to the transmitting of code for the beginner. Is that asking too much for such a good cause? There is more sport in receiving code messages than anything else. The phone hound will soon be tuning into code transmission.

I am a phone-hound, but an amateur at heart. When I try to listen in on the amateur I find mostly speed-stuff. And the best I can do is pick out a few "Q" signals, or letters.

"Amateurs," help us phone-hounds one night a week by transmitting code slowly to us.

Good luck, OM, and 73!

D. H. KAMP,  
Lamy, N. M.

## ATTENTION ANNOUNCERS

Editor, RADIO NEWS:

I do not wish to start a debate or argument through this department of your magazine, but I do wish to bring to mind a statement written by a certain H. K. M. of Kentucky. He said: I am sure if we should go to hear a famous orchestra or noted singer some evening, we should be disgusted beyond measure to have some one come out after each number and make an announcement.

This is reasonable, but he adds: So is it with radio. It is my idea that most broadcast listeners like to know at least the call letters of the station without waiting through an entire program.

I will refer you to one time when I was "disgusted beyond measure."

I had tuned in a station very weakly and when he gave his call I didn't get his last letter. I then tuned it a little louder and waited for his call letters. I was right when I said "waited," for he did not stop to announce through the entire program. When he finally did give his letters they were drowned out by an unexpected spark station.

I think that most broadcast fans would rather have the announcer call his letters between every selection and get the thrill of tuning in a DX station.

I would like to hear from other radio enthusiasts regarding this.

GEORGE NIEMI,  
Seattle, Washington.

## ADVERTISING BY RADIO

Editor, RADIO NEWS:

I was interested in an article in your September number, "Radio Public Impatient with Advertising Talks." Realizing that there are at least two sides to every question I would like to say a little on the other side. I am not interested in selling anything through advertising but simply one of the many Radio users who enjoy good entertainment by radio, and a minimum amount of interference.

Let us take for instance the case of Mr. King who thought he would be entitled to send a bill for his time to the Oil Company who took up so many minutes in forcing him to listen to an indirect advertisement. I do not know Mr. King personally, but I think it is safe to say that he is spending some money for magazines and papers and some time in reading them. I wonder if he ever thought of sending a bill to the publishers of these magazines or papers for the time required in reading these advertisements. I understand that if we were to buy our magazines without advertisements we would have to pay several times the present price of these magazines, as you have doubtless found true of your own magazine. There is no secret about the fact that the advertisers are paying the bulk of the cost of publishing practically all of our magazines and papers. Of course one might say that he is not obliged to read the advertisements in the magazines and that he was obliged to listen to the talk by Radio or perhaps lose his station. I do not believe it is possible for a person to read a magazine without at least getting impressions from the advertisements, which run along the side of the reading matter, either from pictures or from catchy head lines. Another proof that we are obliged to read the advertisements is, if now the advertiser is paying the bulk of the cost of producing a magazine, he is doing it because it is a good paying investment, and if we

(Continued on page 576)



**T**HIS Department is conducted for the benefit of our Radio Experimenter. We shall be glad to answer here questions for the benefit of all, but we can publish only such matter as is of sufficient interest to all.

1. This Department cannot answer more than three questions for each correspondent.
2. Only one side of the sheet should be written upon; all matter should be typewritten or else written in ink. No attention paid to penciled matter.
3. Sketches, diagrams, etc., must be on separate sheets. This Department does not answer questions by mail free of charge.
4. Our Editors will be glad to answer any letter, at the rate of 25c for each question. If, however, questions entail considerable research work, intricate calculations, patent research, etc., a special charge will be made. Before we answer such questions, correspondents will be informed as to the price charge. You will do the Editor a personal favor if you will make your letter as brief as possible.

**POLARITY OF BATTERIES**

(779) Mr. John D. Davis, Blackfoot, Idaho, asks:

Q. 1. Please give an infallible proof for telling the positive and negative of a battery when the terminals are not marked.

A. 1. A simple and reliable method is to immerse the wires running from the two battery terminals in a glass of salt water. The negative wire will give off a large quantity of bubbles.

Q. 2. Please publish a two-tube regenerative hook-up using audio frequency amplification.

A. 2. This circuit will be found in these columns. An ordinary variocoupler may be rewound so that it can be used in this set. "B" is the secondary and consists of about 45 turns of No. 22 S. C. C. wire wound on the stator of the coupler. "C" is the tickler, and the rotor of the coupler can be used for this without rewinding. "A" is an aperiodic primary and consists of ten turns of No. 18 S. C. C. wire wound about 1/4 inch from "B."

Q. 3. What is the average range of a five-watt C.W. set?

A. 3. We cannot give the range of a five-watt set, as this depends upon local conditions, type of circuit used, efficiency of antenna, etc. Under good conditions it is about 50 miles.

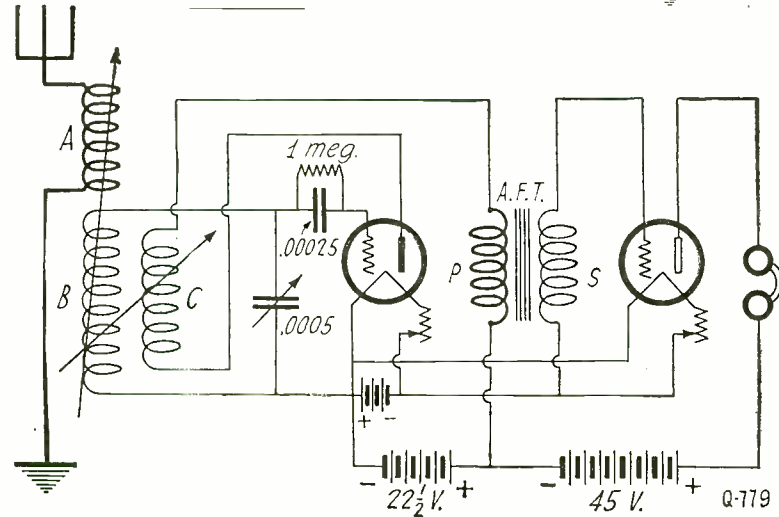

**C.W. AND PHONE TRANSMITTER**

(780) Mr. Harold Dieter, Brooklyn, N. Y., requests:

Q. 1. Please publish a transmitting hook-up using two W.E. VT-2 tubes. This circuit should have one modulator and one oscillator. Both C.W. and phone are to be used.

A. 1. This hook-up will be found in these pages. A DPDT switch is used to change from C.W. to phone. When thrown to the left both tubes are used as oscillators and when thrown to the right one is used as an oscillator and the other as modulator. A standard C.W. inductance is used in this set.

**HARD TUBE AS A DETECTOR**

(781) Mr. Clifton A. Barber, Ganesvoort, N. Y., asks:

Q. 1. Will a UV-201 tube work as a detector?

A. 1. This tube will give fairly good results when used as a detector. It will not, however, prove as efficient as a standard detector tube.

Q. 2. Can dry batteries be used for this tube and how many are needed?

A. 2. Dry batteries can be used but they are not recommended as they will last but a very short time. Four dry cells will be needed to heat the filament of this tube. They must, of course, be connected in series. If four more are connected in parallel with the first four, the batteries will last twice as long.

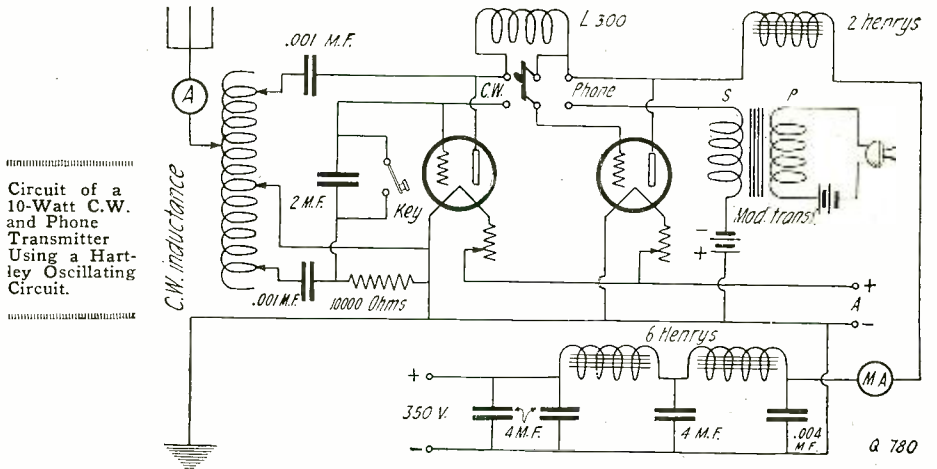

Circuit of a 10-Watt C.W. and Phone Transmitter Using a Hartley Oscillating Circuit.

first audio frequency transformer may be any good transformer. The push-pull transformers are of special make and can be obtained from dealers advertising in this magazine.

Q. 2. Using a five-watt G. E. tube, will a six-volt "A" and a 120-volt "B" battery be satisfactory?

A. 2. Good results will be had with these tubes using the voltages specified.

Q. 3. Would it be practical to use UV-201 tubes in this circuit?

A. 3. These tubes will give excellent results in this circuit when the proper grid bias is used.

**DRY CELL TUBE**

(783) Mr. Edward McGinty, Flint, Mich., wants to know:

Q. 1. Will any of the dry cell tubes on the market give good results in an Ultra Audion circuit?

A. 1. Any dry cell tube will be satisfactory in this circuit.

**SPARK COIL C.W. TRANSMITTER**

(784) Mr. Clarence A. Brockert, Platteville, Wisconsin, asks:

Q. 1. When the power for the plate of a five-watt tube is supplied by a Ford spark coil, can I use a rectifier on each side of the output of the coil, and if so, how many jars shall I use?

A. 1. The plate voltage supplied by a Ford coil can be rectified and filtered and much better results will be obtained. At least six jars on each side of the line should be used.

Q. 2. Please give data on a suitable filter for such a circuit.

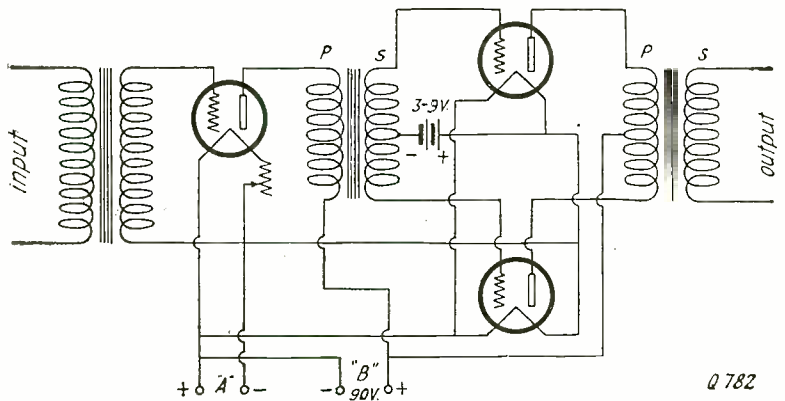

Here is the Circuit of a Two-Stage Audio Frequency Amplifier the Second Stage of Which is Connected Push-Pull Fashion for Power Amplification.

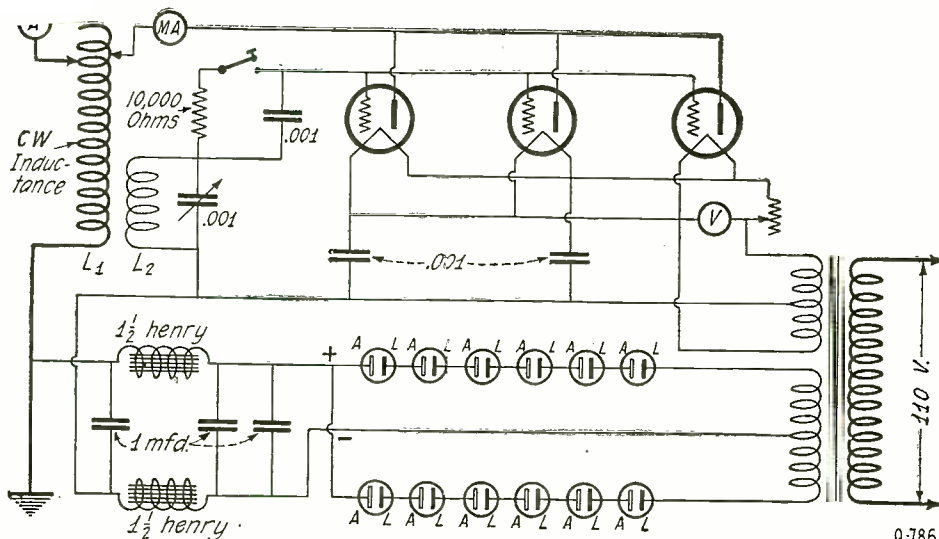

The Sure-Fire or IDH Circuit Can Always Be Relied Upon for Good Work. The Grid Tickler Coil "L-2", May Consist of About 15 Turns of Bell Wire on a Tube Small Enough to Fit Inside of "L." This Coil Should Be Wound in the Opposite Direction to "L."

A 2. A diagram is given showing the complete circuit of this transmitter. The same storage battery may be used for the filament and primary of the coil, but better results will be obtained with two as shown.

Q. 3. What are the dimensions for a good antenna to be used for receiving and transmitting?

A. 3. This antenna should be of the inverted "L" type 60 ft. long, consisting of four wires on nine-foot spreaders. The lead in should not be more than 45 ft. and should be a cage of 6 wires, 6 inches in diameter.

**THREE STAGE TUNED R. F.**

(785) Mr. John L. Hirt, Cincinnati, Ohio, requests:

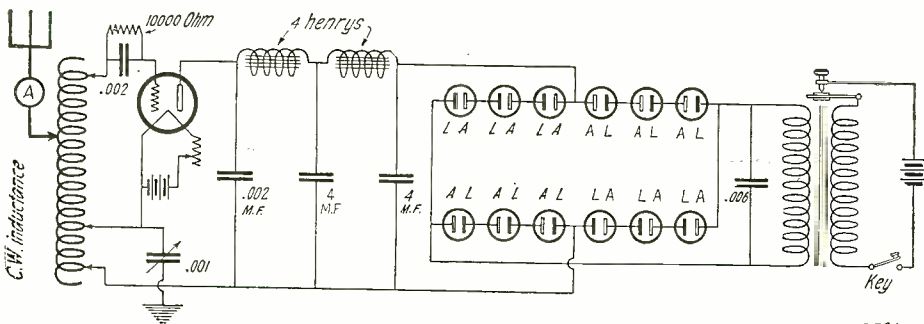

Real C.W. Signals Can Be Obtained from a Spark Coil C.W. Set by Rectifying and Filtering the High Tension as Shown Here.

Q. 1. Kindly publish a hook-up of a three-stage tuned radio frequency amplifier.

A. 2. A receiver of this kind would be very difficult to tune. A set of this nature would tune very sharply and each stage would have to be tuned exactly at the same time or no signals would be received. The only practical system is the neutrodyne which has been published in a previous issue.

**SURE FIRE CIRCUIT**

(786) Mr. Geo. H. Thompson, Plains-Ville, Pa., asks:

Q. 1. Please show a diagram of the Sure Fire circuit used at Station IDH. Three five-watt tubes are to be used.

A. 1. This circuit will be found on these pages.

Q. 2. What is the wave-length of an aerial 100 ft. long and 40 ft. high with a lead in of 35 ft.?

A. 2. If it is a single wire, the wave-length of this aerial is approximately 180 meters.

**ULTRA AUDION CIRCUIT**

(787) Mr. S. W. White, Oakland, Cal., writes:

Q. 1. Please furnish a hook-up for a single-tube ultra-audion receiver.

A. 1. This hook-up will be found in answer to question No. 615 in the March, 1923 issue of RADIO NEWS.

Q. 2. How much more energy is used by the WD-11 than by the UV-199 tube?

A. 2. The filament of the WD-11 consumes .37 watt and the UV-199 consumes .18 watt.

**GREBE CR-12 RECEIVER**

(788) Mr. W. R. Haase, E. Cleveland, Ohio, requests:

Q. 1. Please publish the circuit used in the four-tube Grebe Broadcast receiver.

A. 1. The diagram appears in these columns. Variometers should be used that can have the rotors and stators separated as shown in the circuit.

**COUPLER FOR SINGLE CIRCUIT**

(789) Mr. Earl Egger, Winston, Mo., asks:

Q. 1. Is it necessary to use a special type of vario-coupler with a single-circuit set?

A. 1. Any good standard vario-coupler may be used with a circuit of the single-circuit type.

Q. 2. Can a WD-11 tube be used with honey-comb coils?

A. 2. WD-11 tubes can be used in connection with any tuner.

**100-METER TESTING STATION**

(790) Mr. A. M. Held, Osceola Mills, Pa., writes:

Q. 1. On the night of August 28, I heard a station on phone which signed 8XS. This station announced they were testing on 100 meters. What is this station's location?

A. 1. This is the Westinghouse radio phone testing station located at Pittsburgh, Pa.

Q. 2. I am using a three-circuit tuner consisting of one vario-coupler and two variometers with one stage of audio frequency. Most of the

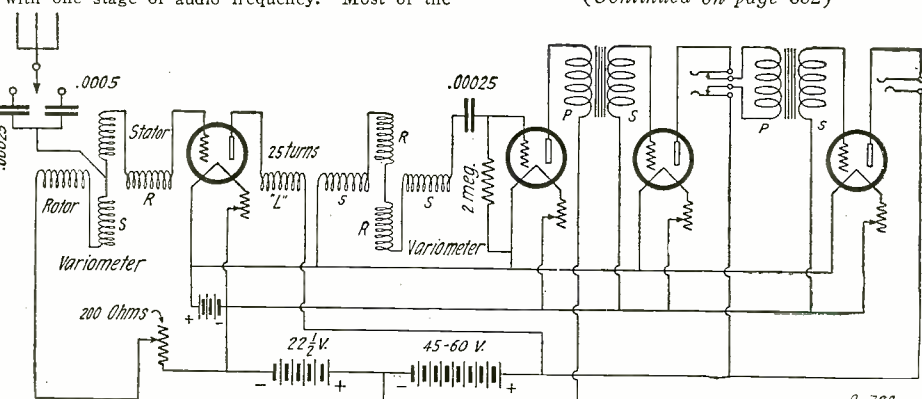

The Circuit Used in the "Grebe 12" Receiver. Coil "L" is Wound Directly Over the Stator Winding of the Variometer.

time I get a squealing sound. Can you explain the cause of my trouble?

A. 2. This may be caused by too much regeneration, or too much "B" battery voltage. It is also possible that one or more cells in your "B" battery are defective or that there is a defect in the wiring of the amplifier.

Q. 3. What would you suggest to increase the wave-length of this set?

A. 3. We would suggest that a small fixed condenser of .00025 MFD be connected from the grid side of the grid variometer to the filament side of the secondary. This should be placed in series with a switch so that it may be cut out of the circuit for lower wave-lengths.

**RECTIFIER TROUBLE**

(791) Mr. Weston Valentene, Kensington, Md., asks:

Q. 1. I am using a small step-down transformer with a secondary voltage of 6-15, to charge my battery. A one-jar electrolytic rectifier is used in series with the secondary and battery. It rectifies but only passes 1/4 ampere. What is wrong?

A. 1. The trouble does not lie in your rectifier, but in your transformer. Evidently you are using a small bell ringing transformer that is only designed to deliver 1/4 ampere. If a higher charging rate is desired, a transformer of adequate size and design must be used. Also the efficiency of the rectifier is small when used with such low voltage. We would suggest you use the 110 volts directly on the rectifier with a resistance in series with the battery.

**TRANSMITTING ANTENNA**

(792) Mr. J. A. Clark, Milwaukee, Wisconsin, requests:

Q. 1. Kindly give data on a good transmitting antenna.

A. 1. This was answered in Q. 784 of this issue.

Q. 2. Is it advisable to break up the guy wires supporting the mast, with insulators?

A. 2. Better results will be had if this is done. If possible the guy wires should be divided by insulators into short equal lengths.

**FLEWELLING CIRCUIT**

(793) Mr. B. T. Willard, Wilmington, Delaware, wants to know:

Q. 1. Could a variometer be used in the simplified Flewelling circuit instead of the 120 turn tickler coil?

A. 1. A large variometer may be used in the plate circuit for regeneration with fair results.

Q. 2. How many turns of wire are used on the primary coil in this circuit?

A. 2. The primary of a vario-coupler may be used for this coil. It can be made by winding 50 turns of No. 22 S.C.C. wire on a 4-inch tube taking off taps every 10 turns.

Q. 3. Should this coil be in inductive relation to the plate coil?

A. 3. Yes, the plate coil, or tickler, should be in inductive relation to the tuning coil.

**A. C. FROM SPARK COIL**

(794) Mr. Frank Watson, Brooklyn, N. Y., asks:

Q. 1. When direct current is used in the primary of a spark coil, is the secondary voltage direct or alternating current?

A. 1. An alternating current with one-half of the cycle much larger than the other, will be delivered from the secondary.

Q. 2. If alternating current is delivered, explain how it is produced.

A. 2. When the primary circuit is closed by the vibrator, lines of force are sent out and cut the secondary winding, producing a voltage of opposite polarity to that of the primary. When the primary circuit is opened, the lines of force collapse, and produce a voltage of the same polarity as the primary. This is an alternating current, but the last half cycle is much stronger than the first. When the circuit is closed, the self-inductance of the primary is sufficient to retard the current flow considerably in the primary of this circuit, thus slowing up the formation of the lines of force.

(Continued on page 632)

# Radio clear— or radio “chatter”

*How to make your radio set work better*



OPERA SINGER OR PARROT? Distortion in a radio set—like a parrot trying to imitate an opera singer—can only produce discords

EVERYWHERE, tens of thousands of radio owners have adopted the Acme method to secure loud, clear broadcasting. Even stations 500 to as far as 3000 miles away are being clearly heard.

The results have been marvelous. Loud, clear radio concerts are now received with sets which once seemed capable of producing only faint, weak or distorted, almost unintelligible sounds.

Radio and sound engineers, after long research have perfected two instruments which, together, insure maximum volume, clarity and distance. First they designed a special type of amplifying transformer which does not distort over the voice and musical range, to 5,000 cycles.

Its 4.25 to 1 ratio works with any vacuum tube made, either dry or storage battery type.

This is the Acme A-2 Audio Frequency Amplifying Transformer. When used in one stage of amplification (consisting of a vacuum tube, the Acme A-2 itself and certain minor apparatus) it

produces strong, clear signals in any head set. When two Acme A-2's are used, an Acme Kleerspeaker or other loud speaking device will give loud, clear, undistorted music.

### *Builds up incoming waves*

Then they perfected a second instrument which gives any set greater range. It builds up the strength of the incoming radio waves before they are acted on by the detector. So signals from far distant stations (which have never before been of sufficient strength to cause the detector to act) can now be secured—and with the aid of Acme A-2's turned into loud, clear undistorted concerts. This second instrument is the Acme Radio Frequency Amplifying Transformer, and is made in three types, R-2, R-3 and R-4, for more than one stage of radio frequency amplification.

### *Send for booklet*

In order to secure the best results with Acme Transformers, which are sold in all radio stores send for “Amplification without Distortion,” which not only explains how to secure the best results with your own set, but also has wiring diagrams helpful in building a set. Amplification and distortion are clearly explained, and methods of remedying poor results are described. The book also explains how to get Audio and Radio Amplification on the same vacuum tube—the “REFLEX” System. Send ten cents for your copy. Acme Apparatus Company, Dept. 21, Cambridge, Mass., U. S. A.



The Acme A-2 Audio Transformer (shown) and Acme R-2, R-3, and R-4 radio frequency transformers sell for \$5 each. For prices on special transformers for any type of business, send specifications to factory.

# ACME

*for*  
**amplification**

ACME APPARATUS COMPANY, Dept. 21,  
Cambridge, Mass., U. S. A.

Gentlemen:—Enclosed find ten cents (U. S. stamps) (U. S. Coin) for “Amplification without Distortion.”

Name .....  
Street .....  
City ..... State .....

# Let an Experienced Newspaper Man Show You How to Break Into the Newspaper Field

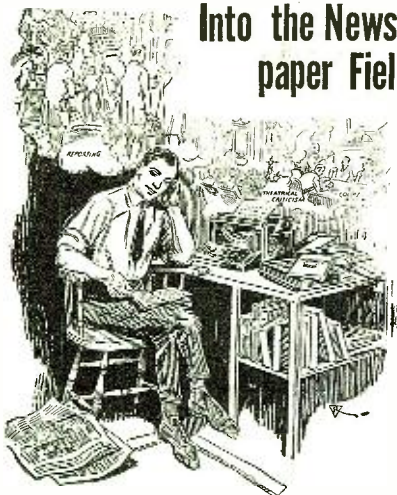

NEWSPAPER work offers countless opportunities for the young man or the young woman who really wants to amount to something. The history of Journalism shows innumerable instances where bright young Reporters have been graduated from newspaper staffs to high places in the industrial and political world. Ex-President Harding was an old newspaper man. Thomas W. Lamont, one of the senior partners of J. P. Morgan & Company, was a reporter on the New York Tribune. Senator Walter E. Edge of New Jersey was, and is, an editor; so is ex-Senator James K. Vardeman of Mississippi. Augustus Thomas, America's foremost playwright, was a reporter on the St. Louis Post Dispatch. Arthur Hopkins and Brock Pemberton, theatrical producers, were newspapermen. Arthur Woods, ex-police commissioner of New York, was a reporter. Newspaper work, in itself, is a field that offers unlimited opportunities—and it often leads to better things.

## FASCINATING WORK

Salaries of \$40 to \$125 a week

There isn't any profession that offers the thrill that Journalism does and there is always room for a live, wide-awake young fellow in this exciting field. Regular Reporters earn from \$40 to \$125 a week. Good deskmen on a daily paper are paid from \$60 to \$100 a week. A "Star" Reporter can command his own salary.

## Part Time If You Prefer

Hundreds of ambitious men and women make extra money by corresponding for newspapers or writing for magazines in their spare time. Many of the most successful reporters of today started in this way. If you have the ability to write, there is always a market for your efforts.

## We Will Teach You Journalism At Home

Henry J. Brockmeyer, Assistant City Editor of the New York Evening Post, will give you a thorough training in Journalism in six short easy lessons. Mr. Brockmeyer is well qualified to teach you. He has trained hundreds of men and women, many of whom have, under his guidance, developed into front rank reporters or feature writers.

Mr. Brockmeyer's course in Practical Journalism will teach you what it would take months of actual newspaper work to learn. The course is complete, authoritative, easy to understand. In it Mr. Brockmeyer has incorporated everything that his long experience of over thirty years in the newspaper field has taught him. It shows not only the way a newspaper is run, giving a detailed explanation of the reportorial and administrative staffs, with the duties of each, but it trains the student in every phase of Journalism, instructing him how to develop a "nose for news", how to write, how to prepare his copy and edit it for publication and drills into him the development of style, with countless references and actual examples.

The complete course comprises six comprehensive lessons just brimful of everything a reporter or correspondent must learn. And it's all interesting reading—more fascinating than any novel. You won't want to stop studying once you start.

## Five Days Trial

To actually prove to you the merits of the course we will send it to you on five days' trial. If at the end of that time you do not feel that you have received more than your ten dollars' worth (the price of the complete course is only \$10) you may return it to us at our expense, and your money will be immediately refunded. We won't even ask you for an explanation—we guarantee to refund your money in full within twenty-four hours after receiving the lessons back.

Just pin a check, money order or ten dollar bill to the coupon below and mail it to us. Then take five days after the course arrives to decide whether you want to keep it or not. You, alone, will be the judge. We know that you will find the course worth many times its price.

THE PRESS GUILD, Inc., 66-R-W. B'way, N. Y.

THE PRESS GUILD, Inc., 66-R-West Broadway, New York City.

Enclosed find \$10 for which you are to ship me at once, prepaid, Henry J. Brockmeyer's complete course in Practical Journalism with the distinct understanding that if I return the course in five days my full \$10 will be refunded and no questions asked.

(Name) .....  
 (Address) .....  
 (City) ..... (State) .....

# Vacuum Tubes for Amateurs

(Continued from page 555)

tained in short time by operating at high temperatures, or it may be obtained in long time by operating at low temperatures. At the same time we must obtain a certain electron emission to produce results required of the tube. Obviously it is desirable for the life to be as great as possible. The reduction of filament diameter is proportional to the evaporation rate as in Fig. 4. An operating temperature may be chosen to give this reduction in any desired time, and it is necessary to designate a temperature which will give a reasonable life, about 2000 hours. That constant filament temperature which will reduce the filament diameter by 10 percent in 2000 hours is called the SAFE TEMPERATURE. It is the temperature at which tube filaments should

be operated to secure maximum life and maximum operating efficiency. The safe temperature will naturally depend upon the size of the filament, for the evaporation depends upon this. In Fig. 5 are plotted the safe operating temperatures for different sizes of tungsten filaments, and it will be seen that the larger the diameter of the wire the higher is the safe operating temperature. In the same figure are plotted the filament energy consumption and the emission at the safe temperature for various sizes of wire.

## VARIATION OF FILAMENT LIFE WITH TEMPERATURE

The great importance of constantly working filaments at their rated safe temperatures will be evident from the following instructive figures. The safe temperature

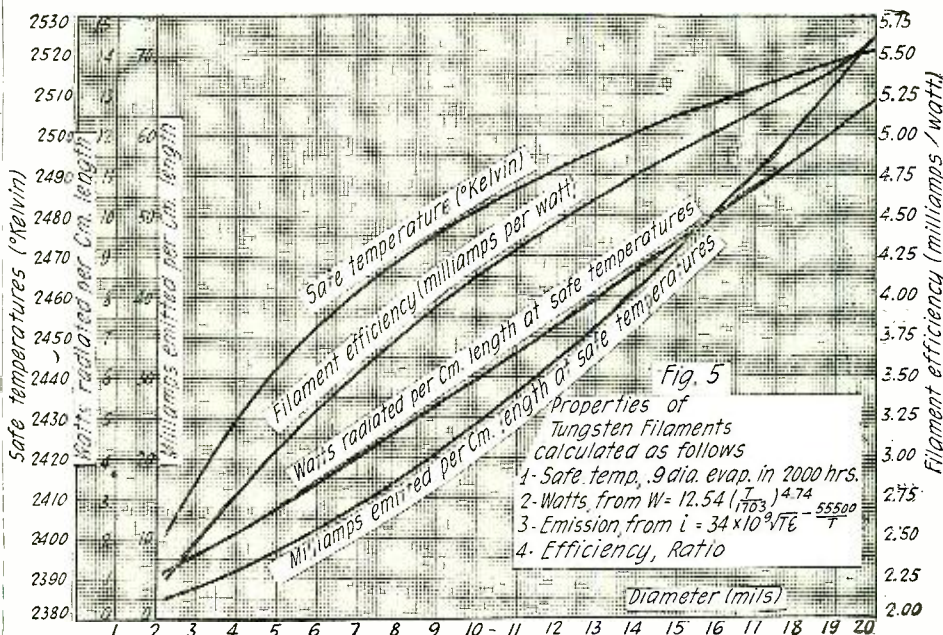

Such Curves Permit One at a Glance to See the Efficiency of a Filament Such as is Used in a V.T.

be operated to secure maximum life and maximum operating efficiency.

The safe temperature will naturally depend upon the size of the filament, for the evaporation depends upon this. In Fig. 5 are plotted the safe operating temperatures for different sizes of tungsten filaments, and it will be seen that the larger the diameter of the wire the higher is the safe operating temperature. In the same figure are plotted the filament energy consumption and the emission at the safe temperature for various sizes of wire.

## FILAMENT EFFICIENCY

The efficiency of any device is defined as the ratio of the work it does to that which is put into it. In the case of the vacuum tube filament it has a certain definite function to perform, namely, to emit electrons. For any given purpose it has to emit a certain number of electrons. Thus it has to emit more for transmitter tubes than for receiver tubes. The less energy required in the filament to produce the required electron emission the greater is the filament emission efficiency. This is defined as the ratio of the electron emission to the energy expended in the filament to produce it. In Fig. 5 is also plotted the curve for the filament efficiency of tungsten wires at the safe temperature. The larger sizes of tungsten wire have a greater filament effi-

ciency than the smaller. In this respect oxide coated platinum filaments are far superior to tungsten filaments, their filament efficiency being very much higher. The oxide coated platinum filaments require very much lower temperatures to produce a given electron emission than tungsten. This explains why the oxide coated filaments are worked at such low red heats whereas the tungsten has to be heated to whiteness. The oxide coated filaments, therefore, have a much longer life.

In other words, since the filament evaporates three times as fast at this slightly higher temperature it will last only one third as long as it would at the safe temperature.

It is important to realize what this means. A 2 per cent increase in current in the filament, which may be hardly noticeable on the ammeter, produces only a 1 per cent rise in filament temperature, which is sufficient to reduce the life of the tube from 2000 hours to 666 hours. The life of a tube decreases remarkably rapidly with increase in temperature. Fig. 6 illustrates this fact clearly. It shows the life of a 10-mil. tungsten filament at different temperatures. At 2480 degrees its life is 2000 hours, and at 2500 degrees, it is 1450 hours. The very sharp slope of the curve shows how fast the life falls for small temperature rises.

In order to secure our maximum 2000-

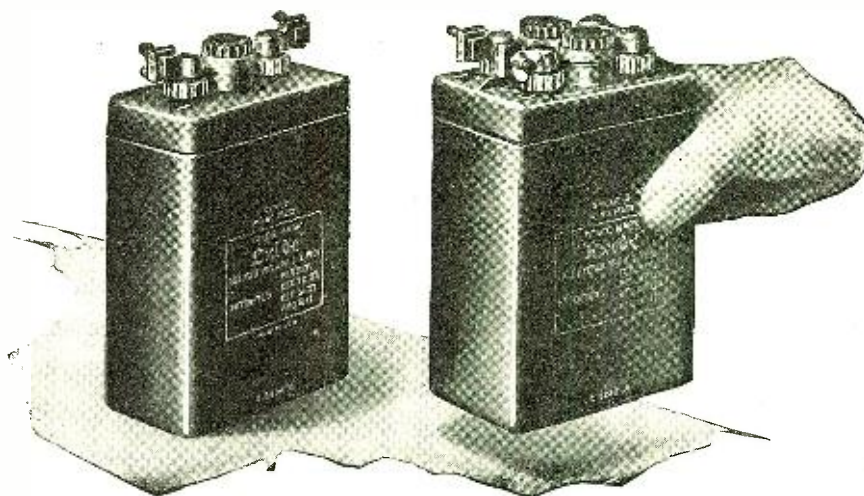

# Midgets in size—but giants in power

**I**MAGINE a radio storage battery so light that you can lift it on the palm of your hand, but powerful enough to supply all the current you need for long-distance receiving—and then some!

The new two- and four-volt Exide A Batteries for low-voltage tubes weigh only five and six pounds each. And they are wizards of efficiency—right in step with the latest developments in radio receiving.

These sturdy little batteries are neat and compact. They were specially designed for WD-11 and UV-199 vacuum tubes, but can be used with any low-voltage tube. The two-volt Exide A Battery consists of a single cell. It will heat the filament of a quarter-ampere tube for approximately 96 hours. The four-volt A Battery, having two cells, will light the filament of a 60 milli-ampere tube for 200 hours.

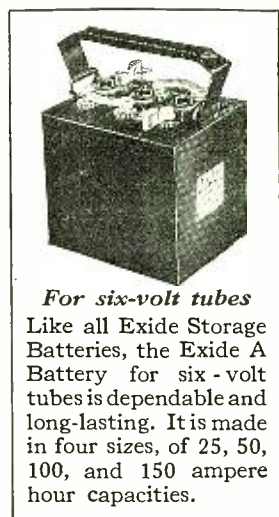

*For six-volt tubes*

Like all Exide Storage Batteries, the Exide A Battery for six-volt tubes is dependable and long-lasting. It is made in four sizes, of 25, 50, 100, and 150 ampere hour capacities.

### *Service you will appreciate*

Exide Radio Batteries are carefully constructed on sound engineering principles. They give the kind of service every radio fan would like to get from his storage battery.

As you know, any variation of current in the plate circuit produces weird sounds in your phones. With an Exide B Battery

Exide B Battery supplies steady, noiseless current. It permits the niceties of adjustment that make radio receiving an unalloyed pleasure.

The Exide A Battery for six-volt tubes has extra-heavy plates, assuring constant potential and uniform current over a long period of discharge. Like all Exide Batteries, it embodies the finest materials available.

### *In marine and commercial wireless*

On sea and on land the Exide plays an important role in the industrial life of the nation. In marine wireless Exide Batteries provide an indispensable store of emergency current. A majority of all government and commercial wireless plants are equipped with Exides.

Exide Radio Batteries are sold by radio dealers and Exide Service Stations everywhere. Ask your dealer for booklets describing in detail the complete line of Exide Radio Batteries. Or write direct to us.

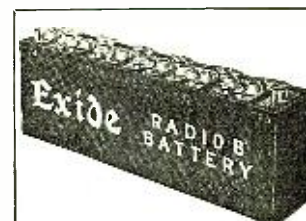

*Exide B Batteries*

give noiseless, full-powered service over a long period of discharge. Designed throughout to prevent electrical leakage. Capacity, 3 ampere hours.

# Exide

## RADIO BATTERIES

THE ELECTRIC STORAGE BATTERY COMPANY, PHILADELPHIA

*Oldest and largest manufacturers in the world of storage batteries for every purpose*

Service Stations Everywhere

Branches in Seventeen Cities

**Quick, Positive Connections**

**UNION RADIO  
TIP JACKS**

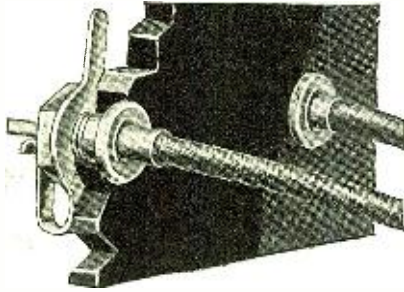

**Cost Only 25c a Pair**

That they give you quick, positive temporary connections is only one of the many big advantages of Union Radio Tip Jacks. Just what you want when you build your own set or experiment with different circuits and hook-ups.

They can be attached to all standard thicknesses of panels. The bushing is 1/4" in diameter and fits a 17/64" hole. Will grip all wires from 24 B & S gauge up to antenna wire, battery leads, loading coils and vacuum tube lugs.

No parts to chip, lose or deteriorate. All parts heavily nicked.

**Other Guaranteed Parts**

Dial adjusters for minute variations in capacities of variable condensers. Price 60c.

Variable Condensers. Famous for performance. Without dials, 3 Plate—\$1.00; 13 Plate—\$2.00; 23 Plate—\$2.30.

Tube sockets of molded condensite highly polished. Phosphor Bronze contact springs. Reinforced bayonet slot prevents breakage. Accommodates all standard tubes. Price 75c.

Should your favorite Radio Store not carry Union Radio Tip Jacks and Guaranteed Parts send your order direct to us, also write for your copy of "The Union Radio Catalog "C."

**Retailers and Wholesalers**

Samples of our guaranteed, reasonably priced "Quality Products" sent on request. Our terms and trade discounts are liberal. Write for our proposition.

UNION RADIO CORPORATION  
200 MT. PLEASANT AVENUE, NEWARK, N. J.  
NEW YORK OFFICE, 116 WEST 32nd STREET.

hour life it is necessary to keep the filament at constant safe temperature throughout its life. The importance of the above analysis arises from the fact that in practical operation we have no direct measure of the filament temperature, but must rely upon indirect indications of meters, such as ammeters, voltmeters and wattmeters. Since the filament is continuously evaporating the temperature conditions are variable. It is necessary to operate the filament at conditions which will keep it nearly constant in temperature. We have only three modes of controlling this, namely: (1) to operate the filament at constant current, (2) to operate the filament at constant voltage, and (3) to operate the filament at constant power. Each of these methods produces different results.

As the filament is used it constantly evaporates, and its diameter decreases, therefore its resistance must increase. If the current is kept constant the  $iR$  watts increase. This power increase results in a higher temperature according to Fig. 3, the evaporation increases still more at this higher temperature. This cycle keeps up with the result that its effects are cumulative and life decreases very rapidly. If the voltage is kept constant the filament energy consumption,  $V^2/R$ , decreases (for  $V^2$  is constant and  $R$  increases due to evaporation), thus the temperature would tend to decrease. When the power is held constant we have to consider the joint effects of voltage and current. This entire problem is subject to analysis and the curve in Fig. 7 shows the results. Here the variation of filament temperature is plotted as a function of the product of current and different powers of voltage, as  $iV^0$  (constant current),  $iV^1$  (constant power),  $iV^2$ ,  $iV^3$ , and so on. From this curve it is seen that for  $iV^0$  constant, which is constant current

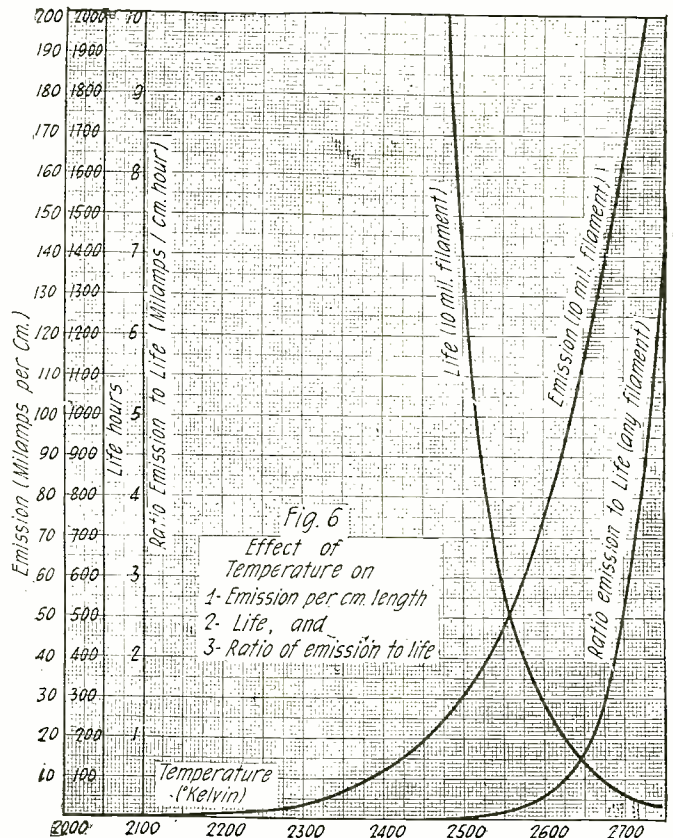

The Life of a Vacuum Tube Decreases Very Rapidly for Only a Small Increase in Temperature as May Be Seen in These Curves.

since  $V^0$  is unity, the temperature rises enormously, hence life is decreased. For  $iV$  constant, which is constant power, the temperature rise is only about 3 per cent, but as we saw by the above analysis that a 1 per cent rise in temperature reduces tube life markedly, this is not a desirable method of operation either, although it is much better than constant current. For constant voltage, which is not shown on this curve, the analysis shows that a reduction of temperature results (this reduction was qualitatively shown at the beginning of this paragraph), the reduction being about 2 per cent. As far as tube life goes the best method of operation is to work with filament terminal voltage constant. Of course this slight reduction in temperature will result in diminished electron emission hence reduced output from tube. In the long run this will be found more desirable than very low life. The analysis of Fig. 7 shows that the filament is held at constant temperature if the product of  $iV^3$  is held constant. But since there are no meters reading such a product, this method of operation is out of the question.

This discussion should be of considerable help, as many amateurs are doubtful as to the best method of working tubes. There is no question but that constant voltage is most suitable.

**CONTROL OF EMISSION**

When a body is charged to an electric potential  $V$ , an electric field of force exists around that body, and is most intense near it, but falls off in intensity as the distance from it increases. This field acts on other charged bodies in it. If they are charged with the same sign of potential they are repelled; if of opposite sign they are attracted. Thus we saw that the electrons emitted from a hot filament in the field of a positively charged plate are attracted to the plate producing a current. If the plate were negatively charged the electric field produced by it would repel the electrons, hence no current would flow.

**APPLICATION TO RECTIFIER**

This action of the electric field on charged

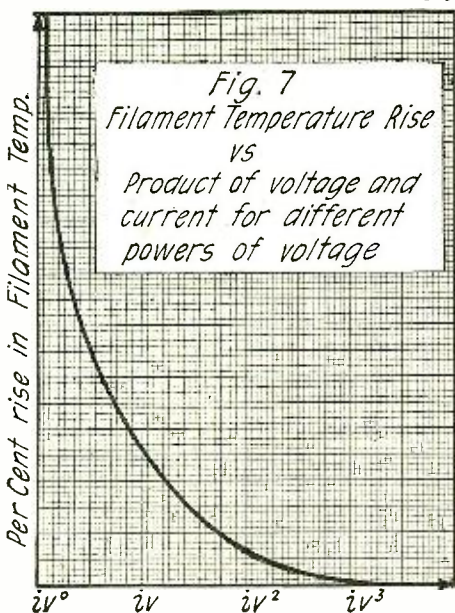

Curve of a Filament Operated at Constant Power.





**Reliable RADIO Goods**

**Distributors for Radio Corporation of America**

- Grebe
- Magnavox
- Brandes
- Murdock
- Nath. Baldwin
- Burgess
- Se-Ar-De
- Acme
- Remler
- Dubilier
- Gould
- Signal
- Cutler-Hammer
- Frost

and other manufacturers of high standing.

We carry a comprehensive stock of the latest receiving sets, parts and supplies of the leading manufacturers, and ship from stock promptly.

**SEND FOR THESE**

- UV-199 Tubes—Genuine 3-volt 06 ampere dry battery tubes made by Radio Corporation of America. Most wonderful tube made. Detector or Amplifier .....\$6.50
- Adapted for UV199 Tube to fit it to standard socket ..... 0.50
- Univernier—A geared dial for close tuning. Mention size of condenser or variometer shaft. Complete with dial ..... 1.25
- Howard 25-Ohm Rheostat—Suitable for the new UV-201-A tubes ..... 1.00
- Cutler-Hammer 25-Ohm Resistance—A variable resistance which attaches to any rheostat to fit it for dry battery tubes ..... 0.25
- Cutler-Hammer "A" Battery Switch—Requires only one hole in panel.... 0.70
- Barkeley-Lightning Arrester Switch—A combination of ground switch and lightning arrester ..... 3.50
- Rubber Ear Muffs—Fit any American make of phones. Made by B. F. Goodrich Co. ....per pair 0.80
- Magnavox M-1—Requires no battery. Loud Speaker of permanent magnet type .....35.00
- General Electric Loud Speaker—Needs no battery. Gives clear and undistorted signals .....36.50

**FREE Illustrated, CATALOG sent on request.**

**Dealers**

Buy reliable equipment from a house of established reputation. Send for catalog of tested and approved apparatus and our discount sheet.

**JULIUS ANDRAE & SONS Co.**  
117 Michigan St., Milwaukee, Wis.

**ANDRAE** In Business Since 1864

bodies is the basis of the rectifier. If the plate is alternately charged by a positive and negative potential the electric field will vary in sign. Hence the electrons emitted from the filament will be attracted and repelled alternately. During the period they are attracted (plate positive) an electron current will flow to the plate. During the period they are repelled (plate negative) no current will flow. If the above alternation of plate voltage were due to an alternating current voltage, an electron current would flow during the positive half cycle, but no current would flow during the negative half cycle. In other words, we have here a device which permits current to flow through it in only one direction, namely from plate to filament. We have thus converted an alternating current into a direct current, since only the positive half of the A. C. cycle gets through; this device may be applied in practice as a rectifier of alternating currents. Not only will it rectify commercial A. C., but if a damped radio frequency wave is applied to its terminals, plate and filament, it will rectify this wave in a similar manner since it is also an alternating current. In other words it will behave as a radio frequency wave detector, its rectifying action being similar to that of a crystal. Practical applications of this principle are made in the design of high voltage rectifiers as the Kenetron, and two element detectors such as the Fleming valve and many of the so-called "Diode" tubes now being sold.

**POTENTIAL GRADIENT**

It was stated above that the intensity of the electric field due to the plate was most intense near the plate and fell off as the distance from the plate increased. In Fig. 9 we have straight filament and plate. The

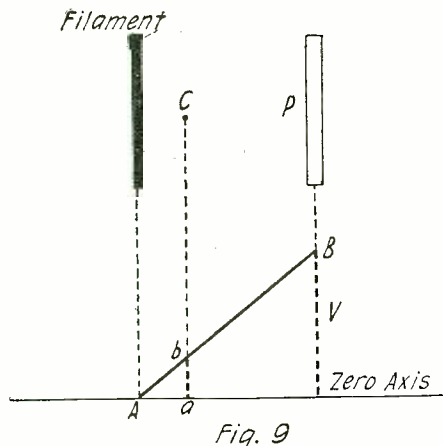

Potential Gradient Between Filament and Plate

plate is charged to a potential V, the filament is assumed at zero potential. The variation in field intensity may be considered from the point of view of the potential gradient or slope of potential. Thus, at the filament the voltage is assumed to be zero, whereas at the plate it is V. As we move from plate to filament the potential decreases uniformly as indicated by the sloping line AB. At any point between the filament and plate, as at C, the intensity of the electric field is measured by the potential gradient, in this case the measure would be ab. Thus a voltage V applied to plate P produces an electric field between filament and plate which may be measured by this potential gradient. This gradient shows that it requires V volts at P to produce an equivalent effect of ab volts at C. If, therefore, we could apply ab volts at C the effect would be the same as that produced by the much larger V volts at P. Now the voltage V on plate P attracts electrons which are emitted by the filament. This same control may be exerted at C by the much smaller voltage ab. Furthermore it may be

**KLAUS RADIO SERVICE**  
**Makes Money for Dealers**

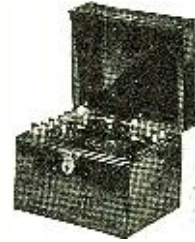

**Get Free Bulletin**

Klaus Radio Dealers receive expert service in radio problems and in radio merchandising. Our dealers *make more money*. We want a dealer in every city and town. Some territory is still open. Write for our trade discount lists and the "Klaus Radio Bulletin."

**KLAUS RADIO & ELECTRIC CO.**  
Authorized Distributors  
Dept. 200 EUREKA, ILL.

**DURATEK**

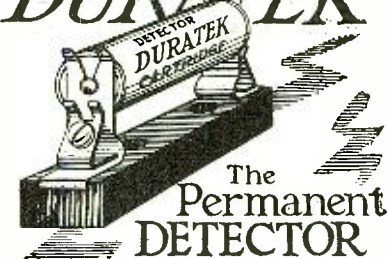

**The Permanent DETECTOR**

(Patent Pending)

**FOR THAT REFLEX!**

Requires no adjustment and works surely, clearly and permanently, in any radio circuit where a Crystal Detector has been used. Ideal for use in connection with REFLEX circuits and other type of amplification. Absolutely guaranteed against imperfection or faulty operation.

FOR PANEL MOUNTING \$1.25  
MOUNTED \$2.00

At your dealer or direct from us.  
Write for informative circular

**The Erisman Laboratories**  
Washington Hgts Bldg. Dept. K, 168 St. & Mitchel Sq.  
NEW YORK

**Marvel - Capacity - Switch**

Receives long waves in the parallel position; short waves in the series position; and waves of medium length by eliminating the condenser entirely.

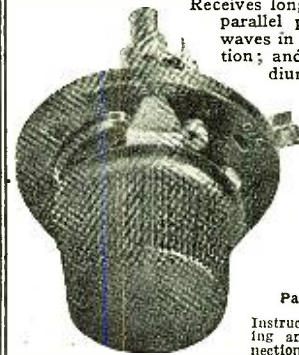

**THREE-WAYS**

Series, Parallel, Direct-Ground  
Patents Pending

Instructions for mounting and for wire connections given with each instrument.

Dial-mounted  
Strictly of Anti-Capacity Type.

List Price \$1.25

Attractive discounts for dealers and jobbers.

**MARVEL-SWITCH CO.**  
28 WEST 25th STREET NEW YORK

# Vacuum Tubes Do Triple Duty With Erla Synchronizing Transformers



Perfect synchronization of received and reflexed r. f. currents make Erla radio transformers indispensable in reflex work. List, \$5

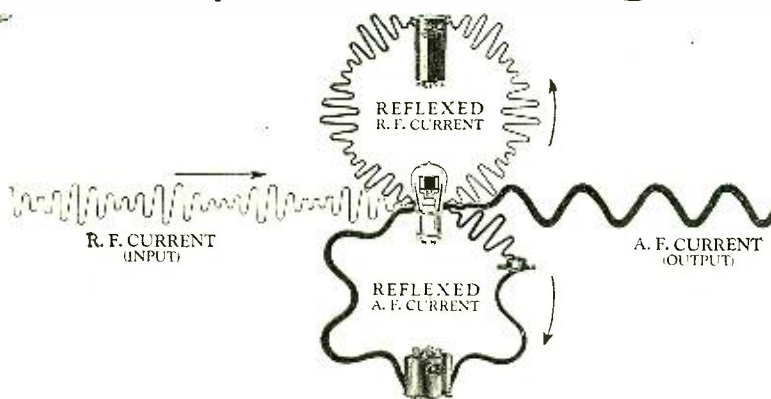

Rectified radio, frequency and reflexed audio frequency currents are accurately synchronized by Erla audio transformers. List price, \$5

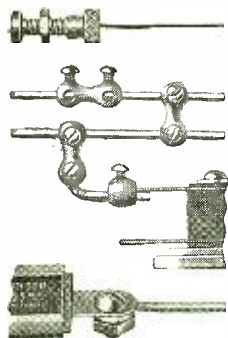

Difficult, dangerous use of soldering irons is eliminated by Erla solderless connections, saving time, temper and money. List, 5c ea.



Providing utmost sensitiveness with perfect stability, the Erla fixed crystal rectifier is uniquely adapted for reflex work. List, \$1



Erla tested capacity condensers are unequalled in rigid, unvarying accuracy, so vital to success in reflex work. Eleven sizes, 35c to \$1 ea.

JOBBERS—Write for our liberal terms and discounts

For the first time, the full efficiency of vacuum tubes is completely utilized and brought under control.

In Erla reflex circuits, tubes do triple duty, providing simultaneous amplification of radio frequency, reflexed radio frequency and reflexed audio frequency currents. Yet, so precise is the manipulation of this complex current flow, that the tremendous gains resulting are achieved without a single deterrent flaw.

Not only do Erla reflex circuits demonstrate decisive superiority in range and volume, but they are also unequalled in selectivity, purity of reproduction, and ease of control.

Even the single-tube circuit provides far-flung loud speaker range, while the three-tube circuit surpasses costliest multi-stage amplifiers in transcontinental loud speaker reception. And the two-tube circuit is but a step behind.

Essential to the operation of these circuits, and the secret of their success, are Erla synchronizing radio and audio transformers. Providing perfect synchronization of received and reflexed currents having the same phase characteristics, they assure tremendously magnified amplification without trace of instability or distortion.

Complete working diagrams and descriptions of perfected Erla reflex circuits are set forth in Erla Bulletin No. 14, obtainable gratis from leading radio dealers. Or write us direct, giving your dealer's name.

## Electrical Research Laboratories

Dept. C

2515 Michigan Avenue, Chicago



Erla bezels greatly enhance the finest cabinet assembly. Telescoping rim, in bright nickel or dull enamel, fits any 3/4" to 1" panel. List, 20c



Exquisite beauty is added to surpassing strength in Erla sockets, with triple-nickeled metal parts on a polished Radion base. \$1 ea.



Manufactured with jeweler's precision, Erla phone plugs, handling two sets of phones at a time, are unequalled in quality and value. List, 75c

# ERLA

TRADE MARK REGISTERED

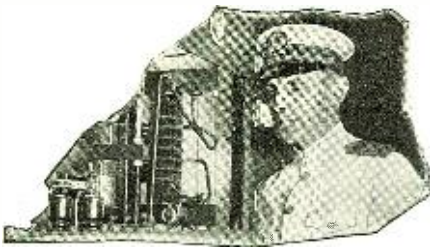

Mr. F. E. Black, Chief Radio Officer, S. S. America—a former student of the Radio Institute of America.

# Men Are Needed for Positions in Radio

You may know nothing about radio today, and yet in a few months be holding a position as radio operator—perhaps traveling to places you have always dreamed of seeing. Earning good pay at the same time. And started on a career that holds big future opportunities.

## Study at Home in Spare Time

Since 1909, we have been training the men who now hold the big jobs in radio. But there are not enough trained men today to keep up with the demand. We have therefore prepared a Home Study Course that starts with the beginnings of electricity, and goes right through the most recent commercial practice. This course prepares you for your first-class operator's license.

## There Are Positions for Every Trained Man

This Institute is conducted by the Radio Corporation of America, the greatest radio organization in the world. In choosing men for ship and shore positions, the Radio Corporation gives first preference, always, to graduates of the Radio Institute. Learn more about the course and the opportunities, by sending for our booklet.

### Advanced Radio Course

Great popular demand by the advanced student, experienced amateur and wireless operator has led to the opening of an **ADVANCED HOME STUDY RADIO COURSE**, specializing in C. W., I. C. W., telephone and radio measurements. Investigate!

### Radio Institute of America

(Formerly Marconi Institute)  
Established 1909

324 Broadway, New York City

Indicate by a cross X the course you are interested in:

Radio Institute of America,  
328 Broadway, New York.  
Please send me full information about radio opportunities today, and your  
 COMPLETE RADIO COURSE  
 ADVANCED RADIO COURSE

Name.....  
Address.....

necessary to reduce the voltage on the plate from V to 0 to reduce the electron flow from filament to the plate. However by the introduction of a small negative voltage ab at C the positive field at C due to voltage V may be more than neutralized, hence the electrons will be repelled back to the filament. In other words, by means of very small potentials at a point nearer the filament we may produce the same effects as those produced by much larger potentials at P.

### APPLICATION TO AMPLIFIER, OSCILLATOR, MODULATOR

The above action is made use of by the insertion between filament and plate of a wire grid or mesh. This grid permits the electrons from the filament to flow through it to the plate, at the same time the small voltages applied to the grid control the

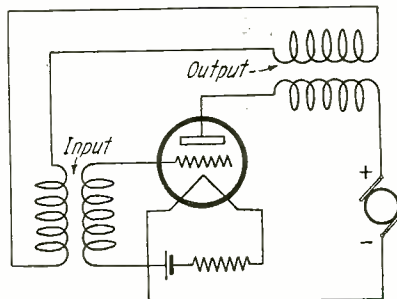

Fig. 10

By Feeding Part of the Amplified Output Back Into the Input We May Obtain Oscillations

flow of electrons. Thus, a small voltage such as that in a receiving antenna is applied to the grid and may produce the same effect on the electron flow as a much larger voltage applied to the plate. This effect is utilized in the plate circuit since the electrons flow through the grid to the plate. Since a small voltage at the grid produces a large effect at the plate the device acts as an amplifier. Any amplifier is inherently an oscillator. Suppose a small voltage is applied to the grid as in Fig. 10, then an amplified output will appear at the plate, since the device amplifies. Instead of utilizing the original source of voltage for the input to the grid suppose we take a small amount of power from the output circuit and feed it into the grid. This will be amplified again. If we keep on feeding the grid from the larger output, this cycle may be kept up indefinitely as long as the filament and plate are supplied with power. Thus the device will oscillate. It may also be used to detect radio frequency waves and modulate them in accordance with speech. Each of these functions will be taken up individually at a later date.

### SPECIAL LICENSES FOR BROADCASTING DEVELOPMENT

In an effort to encourage the scientific development of broadcasting and apparatus for that purpose, the Department of Commerce has created a new form of special license known as the "Broadcasting Development Class." Licenses in this class will be issued to station owners having transmitting and receiving sets of their own design and manufacture, provided in duplicate where failure is likely to occur. These stations are to be used for the improvement of broadcasting and many special requirements are demanded by the Commerce Department, which will furnish detailed information upon application.

### 4RF

The call 4RF has been issued to W. H. Trogdon, 201 Centennial Avenue, High Point, N. C. Would appreciate cards from anyone who hears me on C.W. or phone.

## USE A C H SHARP TUNER DIALS

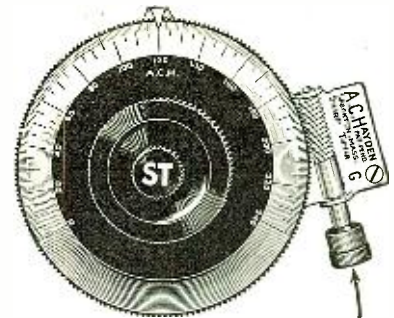

Why the A.C.H. is different

3 in. DIAL

156-10-1

4 in. DIAL

215-10-1

Rough tuning with dial or one thousandth of an inch in either direction.

### Money Back Guarantee

Price ACH 3" Dial complete..... \$2.50  
Price ACH 4" Dial complete..... 5.00  
Regular fitting 5/16" hole, 3/4" and 3/16". Bushings, 5c. each extra. 10c for all.

### LONG DISTANCE A C H DETECTOR SET UNWIRED

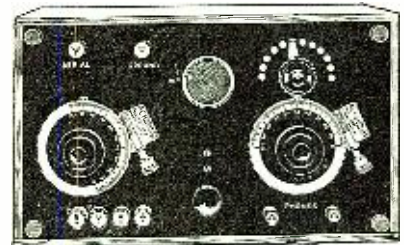

PRICE \$20.00 Including 2-3" ACH Dials  
WRITE FOR 3 WAYS TO PURCHASE

## A. C. HAYDEN RADIO & RESEARCH CO.

Brockton, Mass., U. S. A.

Mail Orders sent prepaid in U. S. A.

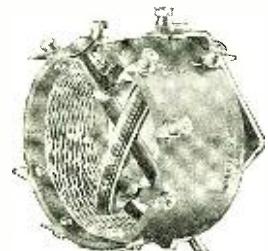

## THE B-T UNIVERSAL TUNING UNIT

There is nothing on the market you can compare with the Bremer-Tully Universal Tuner. It is an entirely new instrument, that gives unequalled selectivity and control on practically all modern circuits.

It replaces coils in Reinartz, Ultra Audion and other regenerative and non-regenerative circuits. In most circuits taps are not required. Also gives remarkable results in Radio Frequency and all Reflex Circuits.

Simple to connect, no soldering; connections made to binding posts, easily changed to any circuit.

Photo diagrams of above, also special Bremer-Tully circuits, in addition to key of windings, furnished. Write today.

**Bremer-Tully Mfg. Co.**  
Canal and Harrison Sts., Chicago, Ill.

## Important Notice Next Month

RASLA SALES CORPORATION

10 East 43rd Street New York City

# The "B" Battery is the Life of Your Radio Set

THIS IS NUMBER ONE OF A SERIES

**T**HE only function of your Radio set is to produce sound-waves—those mechanical disturbances in the air caused by some rapidly vibrating body. So far as the Radio set itself is concerned the actual source of the sound is the "B" Battery. It is not an exaggeration to say that the "B" battery is the "life of your Radio"; for the set itself is simply a device to reproduce sounds, and the sounds all have their origin in the "B" Battery.

The "B" Battery is simply a box full of electrical energy; harnessed for you by experts. Without the Radio wave the flow of energy from the "B" battery is smooth, steady and *silent*. It is the final aim and purpose of all the many parts which go to make up a Radio receiving set, to convert the otherwise steady flow of electrical energy from the "B" Battery, into a rippling, vibrating, throbbing, audible current.

As the sound-waves—whether caused by the human voice in talking or singing, or by musical instruments—are modulated up and down—now high—now low; so does the current from the strongly vital "B" Battery follow the modulations and the variations, so that the original message, in all its delicacy of tone and vibration, comes clear and distinct through your Radio set.

Not a mere adjunct to the pleasure-giving quality of your Radio set is the "B" Battery—instead, it is the vital, life-giving part—the very heart of your Radio set.

Do not slight this vital part—give your Radio set the advantage of the best—use Eveready "B" Batteries.

*Note: This is No. 1 of a series of informative advertisements which will appear in this magazine. They are designed to help Radio users get the most out of their Batteries and Radio sets. If you have any battery problem, write to G. C. Furness, Manager Radio Division, National Carbon Co., Inc., Long Island City, N. Y.*



## The New Metal Case Eveready "B" Battery (No. 766)

*"The Life of Your Radio"*

The same popular 22½ volt Eveready "B" Battery in a new, handsome, durable, waterproof, metal container. Eveready quality throughout. At all dealers, \$3.00.

The "B" Battery is the vital part of any radio receiving set. Eveready Batteries—especially made for Radio—serve better, last longer and give better results.

*Manufactured and guaranteed by*

**NATIONAL CARBON COMPANY, Inc.**

Long Island City, N. Y.

# EVEREADY

## Radio Batteries

*—they last longer*

# RED-HEAD

—a triumph in radio receiver design

We guarantee that "Red-Heads" have every one of these desirable features:

- Extreme Sensitiveness
- Beautiful Tone
- Fine Appearance
- Mechanical Strength

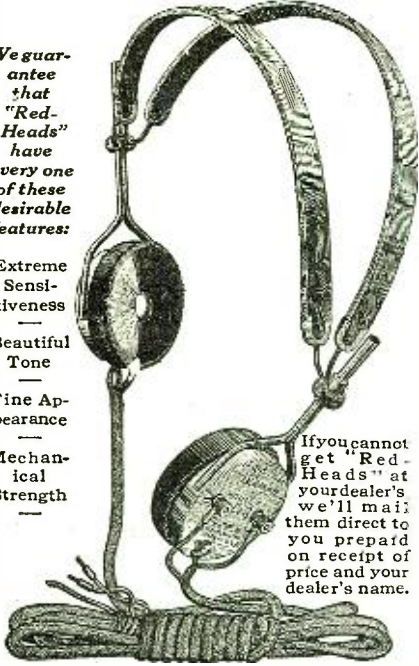

If you cannot get "Red-Heads" at your dealer's we'll mail them direct to you prepaid on receipt of price and your dealer's name.

HERE'S what we say about "Red-Heads"—they're extraordinary radio receivers. We believe they're the best receivers on the market today. Superlatives are easy to say and hard to back up. Here's how we back up ours. We guarantee that you'll like "Red-Heads." You take no risk in buying them. We'll refund your money plus postage if you don't agree with us after trial. "Red-Heads" are the lowest priced, high-grade, aluminum-backed receivers on the market. Nine years of receiver experience are behind their quality.

### What One User Says

The Newman-Stern Co.,  
Gentlemen:  
In 1915 I purchased a pair of your "Red-Head" phones. This pair of phones was one of the first you put out. They are still in good condition and, I believe, beat most of the other phones on the market.

Very truly yours,  
D. J. SAXTON,

Waupun, Wis., July 26, 1923

And "Red-Heads" are better today than they ever were.

**READY NOW!**  
*The New 1924 Model F—3000 Ohms*

The new standard "Red-Heads" have ELEVEN improved features—new this year. Beautiful and graceful in appearance; light in weight; aluminum case; the famous brown-red ear caps; military headband; high-grade cord; exquisitely sensitive and fine toned. 3000 OHMS PER PAIR.

At your dealer's or prepaid on receipt of price. **\$6.50** PAIR Complete

**THE NEW "RED-HEAD" JR.**  
2000 Ohms

Makes its bow to the public this year in response to a demand for an extra fine 2000 Ohm phone. A remarkable production with the same workmanship and guarantee as on our standard Model F. Complete with headband and cord.

At your dealer's or prepaid on receipt of price. **\$5.00** PAIR Complete

Since 1915 Pioneers in Radio—year after year striving to achieve one purpose—better radio receivers.

**THE GUARANTEE**  
Money back if after 7 days trial you're not satisfied that "Red-Heads" are the BEST receivers on the market at the price.  
**The NEWMAN-STERN Co.**  
Dept. RN, E. 12th St., Cleveland, O.

## Correspondence from Readers

(Continued from page 564)

all stopped reading his advertisements, and buying his goods, he would naturally have to stop advertising and the publication would have to go out of existence.

On the other hand, why should we object to direct advertising by Radio. I have been told by several people that they study the advertising sections of magazines more than they do the reading matter. Advertising is valuable to everyone who is buying anything and we all buy more or less. It helps us to know where we can get the best value for our money. I never heard of anyone expecting to get paid for attending an auto show which is 100% advertising.

Someone has got to pay for broadcasting. At the present time it is impossible for the consumer to pay directly for it. Why not let the advertiser pay for it? I think it is safe to say that a direct advertisement by radio, in the form of a talk, one I mean that would be understood as an advertisement, giving full names of the products being talked about, would be as valuable to the advertiser as a large advertisement in a good magazine, therefore he would doubtless be willing to pay the same price for it. Let us assume that this advertiser be allowed five minutes and paid perhaps \$1000.00 for this privilege. One of these talks in an evening would easily pay for the best of talent and also for maintaining a good broadcasting station, and I think that if it was understood that this advertisement was paying for the rest of the entertainment, as it is understood that the advertisements are paying for the magazines, that few people would object to it, and we would be able to have better talent than some that we now get, and probably better Broadcasting stations. This might be carried a step further and Advertising companies formed, for the purpose of selling five or ten minutes each evening, furnishing perhaps two hours of good entertainment and making a fair profit for its stock holders. They would have a great incentive in furnishing the best so that the most people would listen to them and the advertisers would get the best results and be willing to pay the most money, which is just what the best magazines and papers are doing today.

This I believe would solve the problem of maintaining the broadcasting stations that there has been so much talk about lately.

CHARLES W. EDDY,  
Providence, R. I.

### LOOK FOR THE SILVER LINING

Editor, RADIO NEWS:  
I have been a reader of RADIO NEWS for a good many months and L. S. Foster's letter is now the "last straw." I do not wish to throw the hammer, but to say just the way I feel toward such letters. First, RADIO NEWS has published the best hook-ups of any. They all worked for me. I am one of the so-called amateurs, and glad of it. Now about a radio amateur: nearly everyone has a pet in reality or some theory or idea. If any one appears to sneer or doubt this the party resents it. I venture that Mr. Foster is not a mechanic therefore became peeved when his efforts to "build his own" were not up to his expectations. Perhaps he was in this frame of mind when seeking aid from those amateurs who really love the game, and would not stand to have their "pet" flouted. No real

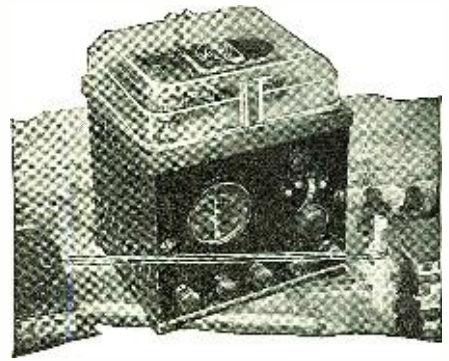

## ONE CHARGER for Every Radio Battery

—And, in fact, the only one which you need. Keeps strong clear signals in your set by keeping the batteries to full capacity.

The Valley Type ABC Battery Charger is made for all storage batteries—2-volt peanut tube batteries, 6-volt A Batteries and 1 to 4 B Batteries. Bakelite panel, glass top—belongs to a radio receiving set.

Frankly, production is limited. Late buyers are going to be disappointed. A lot were last year. Ask to see the Valley Type ABC Charger at any good radio shop.

**VALLEY ELECTRIC CO.**  
3157 S. Kingshighway St. Louis, Mo.

## Valley Battery Charger

# Here It Is!

**HOMMEL'S ENCYCLOPEDIA OF RADIO APPARATUS**  
Price List No. 235-S

**LUDWIG HOMMEL & CO.**  
530-534 FERNANDO ST. PITTSBURGH, PENNA.

**Send for it NOW**

**AMSTERDAM SERVICE EXCHANGE**  
**AMSTERDAM**  
**O H I O**  
"WORLD'S PURCHASING AGENT"

# Radio Catalogue Free—

**Write us  
a post card—**

**Address Dept. 2-R**

and we will send you free this 52 page catalogue of radio sets and parts. It also contains explanation of radio terms, map and list of broadcasting stations and much radio information, including an explanation of successful hook-ups and circuits.

You will be amazed at the low prices Ward's quote. A complete tube set having a range of 500 miles and more, including tubes, head set, batteries, and antenna equipment, as low as \$23.50.

This catalogue contains everything for the expert and amateur. Complete sets and every improved part for building sets, all the most up-to-date devices—at the lowest possible prices.

## Headquarters for Radio

Montgomery Ward & Co. is headquarters for Radio, selling everything direct by mail without the usual "Radio-profits." Why pay higher prices? Ward quality is the best and the prices will often save you one-third. Everything sold under our Fifty Year Old Guarantee,—Your Money Back if You Are Not Satisfied. Write today for your copy of this complete 52-page Radio Book.

**Write to our house nearest you. Address Dept. 2-R**

**Chicago    Kansas City    St. Paul    Portland, Ore.    Ft. Worth**

# Montgomery Ward & Co.

**The Oldest Mail Order House is Today the Most Progressive**



# FRESHMAN RESISTANCE LEAKS

The largest and most Complete line in the World

Our new construction of all types Variable Resistance Leaks produces a product which we can now guarantee as being scientifically correct, mechanically perfect and built for unusual durability.



Every tube and every circuit requires a different leak resistance. You do not know what value is necessary until your circuit is tested. Freshman Variable Resistance Leaks offer an unbroken range of 180 degrees from zero to five megohms.

Base Mounting Type with either .00025 or .0005 Freshman Condenser ..... **\$1.00**  
Without Condenser ..... 75c.



## PANEL MOUNTING FRESHMAN VARIABLE RESISTANCE LEAKS

will enable you to get stations you have never heard before. Can be mounted on any panel in a few seconds. When mounted only the knob shows on the panel. The latest and most essential part of an efficient tube set.

With either .00025 or .0005 Freshman Condenser ..... **\$1.00**  
Without Condenser ..... 75c.



## FRESHMAN "FIX-O" FIXED RESISTANCE LEAK COMBINATION IN ONE

Freshman Condenser .00025 } Price Complete **65c.**  
Leak Mounting  
Freshman Resistance Leak  
Safe-T Handle



## FRESHMAN FIXED RESISTANCE LEAK WITH SAFE-T HANDLE

The only Resistance Leak using no carbon, graphite or lamp black. Guaranteed to remain permanently constant.

Furnished in any value of Resistance from 1/4 Megohm up..... **30c.**



## FRESHMAN NOISELESS TESTED MICA CONDENSER AND LEAK MOUNTING

The Freshman Condenser is so designed that constant equal pressure is exerted over the entire area of the condenser plates and the mounting is part of the condenser itself, which makes this new product the only True and Perfect Leak Mounting on the market.

Combination Condenser .00025 and Leak Mounting... **40c**

At your dealers'—otherwise send purchase price and you will be supplied without further charge.

Also ask your dealer for our free diagrams of the Neutrodyne, Kaufman, and Flewelling Circuits.

**Chas. Freshman Co. Inc.**  
Radio Condenser Products

106 SEVENTH AVE. NEW YORK

dyed-in-the-wool amateur would refuse to spread the "gospel of radio" if approached in the manner of real good fellowship. Try this Mr. Foster and you will always find the glad hand and a smile. RADIO NEWS for me first, last and all the time.  
A. L. GRUBB, Edgemont, S. D.

### IN ANSWER TO MR. FOSTER

Editor, RADIO NEWS:

Referring to Mr. Foster's letter in your September issue I cannot agree with the writer in his first grievance. I have found the Radio amateur in the majority of cases very courteous and willing to give assistance. I have had quite a bit of experience in the Radio game, both installing and building Radio Sets, and it gives me real pleasure at all times to help any of the boys who manifest an interest in Radio. However, I fully agree with Mr. Foster in regard to the Radio dealer, especially the jobber or wholesale dealer as I buy only from them and I have had a variegated experience with this bunch and I have yet to find one who is on the square until he is forced to it and what I mean by this applies to some of the very best (so-called) and reliable dealers in the country. One dealer in particular I was forced to place an account against him in the hands of an attorney for collection before I could get my money back for goods that was returned to him on account of it not being what I had ordered. The game seems to be to unload something on you that you don't want or cannot use regardless of the trouble that it may cause you and these boys are not entirely without ignorance. It is appalling how little some of them know about radio material and in fact anything else that pertains to business. On one occasion I was forced to return a bunch of dials (four times) trying to get 3/16" shaft holes and had to give it up. These dealers are a detriment to the Radio public and the sooner such people can be eliminated the better it will be for all concerned. They seem to have only one idea, to skin you good and hard and let you go and look for another sucker. What we need are reliable dealers and a standard line of goods and competent advice to purchasers who desire it. The Radio enthusiast who starts out now is up against a proposition if he is not versed in what he needs and then he will have a hard time getting what he wants.

L. T. ETHRIDGE, Glennora, La.

### FROM A DEALER AND AMATEUR

Editor, RADIO NEWS:

After reading about five miles of gosh darned argument in RADIO NEWS I feel that the amateurs, broadcast listeners, and manufacturers, and dealers seem to be on the "war path" rather than intending to be friends.

I myself am an amateur, and also a dealer. Personally I have a mighty hard job agreeing with them all, in fact I don't.

Realizing that there are at least a hundred BCL's to every ham, the latter would have a sweet time explaining all the little details in radio to a BCL who wants to become a "radio expert" in five or ten minutes, and condemns every publication because they (the BCL's) aren't willing to take a little time to learn the few Radio characters used in diagrams. Furthermore they want all for nothing. What they get they either keep or brag about. "Two bits" seems an awful lot to pay for a book containing about ten dollars worth of information, yet they prefer taking up several dollars worth of some kind hearted authorities time, and are very willing to

**FERBEND**  
Wave Trap  
The Original Wave Filter

**Stops Interference!**

Eliminates interfering stations. Improves the selectivity of the set. Eliminates local broadcasting. Selects between conflicting stations. Simplifies tuning. Often increases signal strength. Reduces howling and squealing.

The WAVE TRAP is mounted on a Formica panel in a beautiful mahogany finished cabinet 6x5x6, and is a high grade instrument throughout enhancing the appearance of the most expensive sets.

**850** Ferbend Electric Co.  
CHARGES PREPAID  
25 E. SOUTH WATER ST.  
**CHICAGO**

## RADIO LOG



A GREAT INTEREST WILL BE

**ADDED IF YOU KEEP A RECORD OF IMPORTANT MATTERS BROADCASTED**

This book is printed on a quality Bond paper. Indexed and arranged to record all details. It has a flexible, embossed binding, and its general design is such that will cause it to become a very important addition to your set.

Club Secretaries Write for Quantity Prices. 50 Cents Postpaid. No Stamps Please

## RADIO PRINT

216 CIRCULAR ST. TIFFIN, OHIO

# Build Your Own HAZELTINE NEUTRODYNE

with FREED - EISEMANN Licensed Essential Parts

Complete wiring diagram, instructions, etc. sent in special container with patented essential parts. Three NEUTROFORMER COILS mounted on variable condensers, and DOUBLE NEUTRODON (as illustrated), sent for \$24.00. Ask your dealer to show you these parts, as well as complete assembled five-tube Neutrodyne Set in mahogany cabinet. Model NR-5, \$150.

Or send 25c for Neutrodyne Constructor which shows "How to Make the Neutrodyne"

**FREED-EISEMANN RADIO CORPORATION**  
Dept. E

255 Fourth Avenue New York  
Licensed by I. R. M. Inc. Under Hazeltine Patents



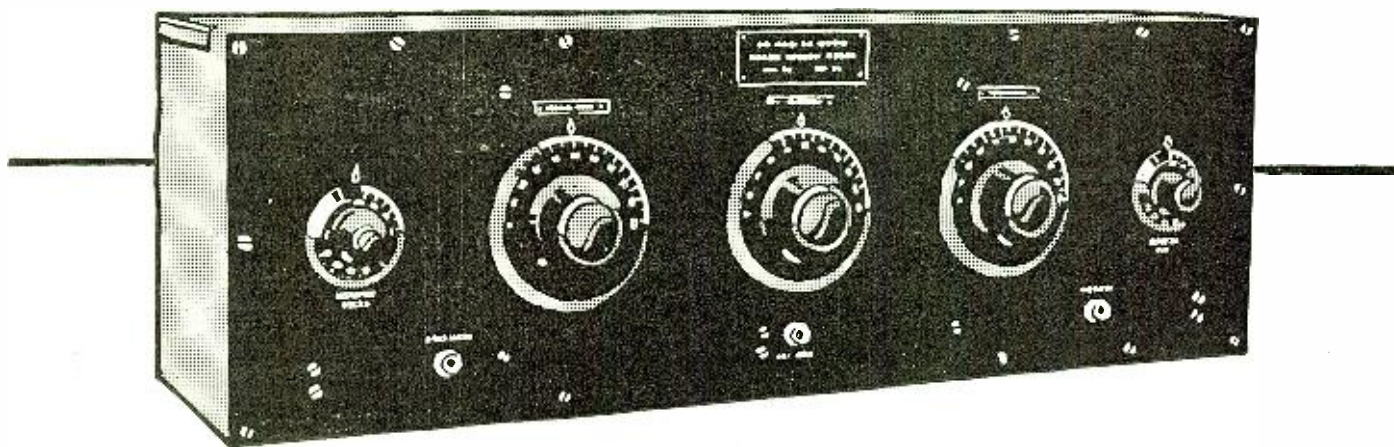

## FORMICA

is used in the new  
**FREED-EISEMANN**  
*N R Neutrodyne\* Receiver*

**T**HE panels of the new Freed-Eisemann Neutrodyne Receiver are Formica. This is natural because Freed-Eisemann have long been consistent users of Formica in all their past radio products.

It is the endorsement of leading radio concerns of this caliber from one end of the country to the other that makes Formica so staple, and desirable a product for the radio dealer to handle. Amateurs know and want it.

Formica panels may be had promptly in *any desired* size. It isn't necessary to take a size that some one else wants to sell.

### THE FORMICA INSULATION COMPANY

4618 Spring Grove Avenue, Cincinnati, Ohio

#### Sales Offices

50 Church St., New York, N. Y.  
 422 First Ave., Pittsburgh, Pa.  
 1042 Granite Bldg., Rochester, N. Y.  
 415 Ohio Bldg., Toledo, Ohio

1210 Arch St., Philadelphia, Pa.  
 1819 Lyndale Ave., S. Minneapolis, Minn.  
 Sheldon Bldg., San Francisco, California  
 Whitney Central Bldg., New Orleans

414 Finance Bldg., Cleveland, Ohio  
 9 S. Clinton St., Chicago, Ill.  
 313 Title Bldg., Baltimore, Md.  
 47 King St., Toronto, Ontario

\*Reg. U. S. Pat. Off.

---

# FORMICA

Made from Anhydrous Redmanol Resins  
**SHEETS TUBES RODS**

---



## A NEW PATHÉ PRODUCT CURTANTENNA

### The Only Variable Loop



Showing Collapsibility and Portability of Curtantenna

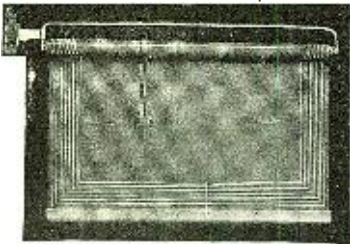

Showing How Curtantenna Can Be Varied In Size

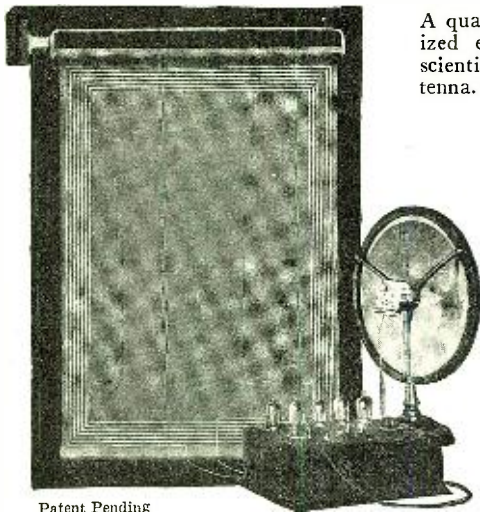

Patent Pending

Showing Curtantenna Fully Extended in Conjunction with Set and Pathe Loud Speaker

A REVOLUTIONARY development in radio aerials for indoor use.

When fully opened is one of the largest and most efficient loops for broadcast reception.

Is instantly collapsible without kinking or tangling the wire.

Ideal for sharp tuning—unsurpassed for distance—reduces static to a minimum. Particularly effective in large cities where several stations are broadcasting at same time. Gives a degree of selectivity hitherto unobtainable.

When closed is as portable as a walking stick.

Comes with wall bracket and swivel or may be attached to any door in house.

Positive in results—very attractive in appearance—easy to handle.

Size can be varied at will.

Over 1500 miles have been covered by users of the CURTANTENNA.

A quarter of a century of highly specialized experience in the manufacture of scientific devices is behind the Curtantenna.

## Price \$8.50

On sale at leading radio stores. If your dealer has neglected to stock the Curtantenna, send remittance direct and shipment will be made, charges prepaid, immediately.

Other Pathé products such as the famous Pathé Loud Speaker, Pathé Dials and Pathé Variometers and Variocouplers have already established themselves as standards among users of the best radio material.

Catalogue of Pathe radio products, together with a detailed wiring diagram of a loop receiving set which covered 1500 miles using a CURTANTENNA, will be mailed on receipt of 4 cents postage. Address Dept. 218.

**PATHÉ PHONOGRAPH & RADIO CORPORATION**  
20 GRAND AVE., BROOKLYN, N. Y.

## TO THE RADIO DEALER.

Let us explain how you can make the sale of our publications a worth while, well paying part of your business. Every one that enters your store is a prospective buyer of RADIO NEWS. RADIO NEWS will sell with little effort on your part.

You may sell our publications on a single copy basis with a fine margin of profit or on a subscription basis with a generous commission allowance.

Write now and prepare for the Fall and Winter trade.

**EXPERIMENTER PUBLISHING CO.,**  
53 Park Place, New York.

"cuss" the latter if they do not know enough to understand him. When they forget their idea of "getting something for nothing" there will be better feeling all around.

Then many of the amateurs are too boastful and try to use technical language that is above them in order that they can "bulldoze" the novice. Many other of these "courteous" hams take delight in unloading their failures on some unsuspecting novice in a way to make a little on the side if possible. Is this the right spirit?

The dealers, I'll admit, all have enough faults, too many to say much about, but, we also have a "helluva" time answering all the public's demands. People in general want radio apparatus for nothing, want it fully guaranteed to do a lot of things that no one with half human intelligence would expect, along with more service than they could get in any other line. With all this, we amateurs and dealers are trying to do the best we can, and rest assured that we are not becoming millionaires.

GILBERT ROBIN.

Gen'l Mgr. Robin Radio Shops.

### AN OPPORTUNITY

Editor, RADIO NEWS:

Here I am again. I thought that I had finished writing letters to you but after reading Mr. Jesse Marsten's article in the September issue I decided to pop off again. Personally I thought his ideas were very good but I believe it will take a little time before his methods can be brought about.

I am boosting the amateurs and have a little idea. Instead of letting some company install and repair equipment and as there are no such companies that I know of, why shouldn't some amateur start such a practice? I installed several sets last spring and had good success with them. Why shouldn't other amateurs do the same? People are willing to pay for repairs and installations and they pay well. I believe if some of these "bugs" would start up service like that it would help clear up this misunderstanding between the amateurs and the BCL's. The BCL's would soon learn that the amateur is his best friend and not his enemy. My big point is to educate the BCL into the mystery of his set. By repair service is one means of doing this. When a man buys a set, nine times out of ten he receives no instructions about the operation of it. By that I mean the tuning and the like. Here is the chance for the amateur to close the breach between the two classes of radio bugs. If you think it worth while you might publish this and maybe someone would answer me on this subject. Awaiting further questions and issues of the RADIO NEWS, I remain.

J. A. WEINGARTNER, JR.

Box 701, U. of Ky.,

Lexington, Ky.

### WORD FROM A HAM

Editor, RADIO NEWS:

You know something about Radio and all its parts. Since you must can you honestly say that Radio is going forward the way you would like it to?

I started when Radio consisted of but code. Today it is a different matter. The stores handling Radio supplies are sure going downhill—also how many people use the new hook-ups published? Not very many, they seem to like to use old ones like the Ultra-Audion with a "newfangled" name stuck on to it and then come over to some poor "Ham" and bawl him out all on account of the said BCL's receiver being on the blink (honestly I have had people come over to my house after hearing some Navy station and blame me for ruining their set). Well anyway the fellow who says that Amateurs will not help him with his set is all wrong or else he has done something to

# Banish Interference—Get Distance!

## It's Easy, When You Know How

The amazing story of Bob Carter, a radio amateur, who became an authority and surprised his friends

By Frank W. Daly



**W**HAT in blazes was the matter with the darned thing anyway? I was mad clean through. I'd been fiddling with my new set for hours and all I was getting was a weak little chorus of six stations and a lot of howls and squawks. I was trying for DX and could not eliminate the interference. Harry Brant was there offering his usual line of stupid suggestions which only made me angrier. "Don't stand there looking at me!" I bawled. "Why don't you do something? Why don't you tell me what's wrong with the thing?"

Harry shrugged his shoulders helplessly. "Sorry, old man, I don't know enough about Radio—you'd better ask Bob Carter, he's the authority around here these days."

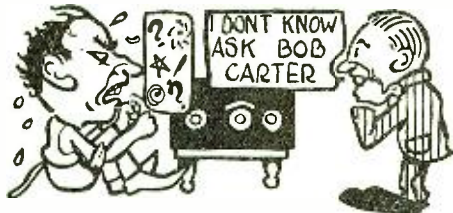

"Bob Carter!" I shouted in derision. "What are you trying to do—kid me? Since when has Bob Carter become a rival of Major Armstrong? Bob Carter! That's a hot one. Say—three weeks ago that boob asked me if a microfarad was a disease germ."

"Just the same, Bob is an expert!" said Harry defiantly.

"Huh!—you've got to show me," I sneered. "Why don't you phone this nine-day-wonder to come over here and see what he can do with this set?"

"All right, I will," said Harry.

Fortunately, my sense of humor came to the rescue just then and I was able to laugh at the picture of utter helplessness I would soon be enjoying when poor old Bob Carter started "fixing" this receiver.

Bob answered Harry's call and said he'd be right over. "—Always glad to be of service." Stupid egotist!

"What's the trouble?" asked Bob, on his arrival a few minutes later.

"Nothing much," I replied non-committally—I didn't want him to have any clues.

"Dandy set!" he commented, surveying my outfit—and I had to admit he sure handled the thing like a seasoned amateur. "There's nothing wrong with it," he said, after a moment, "except—"

With the ease and confidence of an experienced engineer he made some minor adjustment inside the cabinet.

"—Except this!"

To my astonishment WEAF suddenly burst out I

with knife-edge clearness and freedom from interruption.

"Why Bob—" I gasped. I couldn't conceal my admiration. "Gee! You're great! Where did you—? How—? Say—am I crazy or something?"

Bob chuckled—he knew what I was thinking. "Pshaw! There's nothing to it." He protested modestly. "Either of you fellows could do it in half the time it took me. Just think—I can make the dandiest receivers now, and troubleshooting? Easy as falling off a log! But really—there's no credit due me at all. It's easy when you learn Radio the way I did."

I was quite prepared to believe the moon was made of hard-rubber by this time. "Of course we aren't a bit anxious to know how you did it!" I said ironically.



"There's nothing much to tell," said Bob. "You remember I didn't know a thing about Radio, but I was anxious to learn. Still, I didn't feel like wading through miles of mathematics and verbosity to reach my goal. One day—reading a radio magazine—I happened to glance at the ad of the Radio Guild and saw that Kenneth Harkness had written a new kind of home-study book on advanced Radio, a book that assumed you hadn't the slightest knowledge of Radio yet which dealt with the most advanced phases of the subject. This was exactly what I had been waiting for. I mailed the coupon and they shot me the book by return mail.

"Well sir! That very first night I felt myself growing in knowledge—it was wonderful; There was no exhausting fight for understanding because everything was delightfully clear. Each



subject was taken up so smoothly I clean forgot I was studying something that had been considered ponderously scientific. Why—within the first week I was building my own receiver and you ought to see it. Huh! It looks better than most commercial receivers and results, O Boy! Clear across the continent, and stations on almost the same wave-lengths can be tuned apart.

I couldn't get the Radio Guild's address from Bob quick enough. I even used a special-delivery stamp on my letter to the Guild. They rushed me my copy of this astounding book by return mail and eagerly I commenced reading. It was called "Radio Frequency Amplification" and it was surprised at the knowledge Bob Carter

had gained. I was even more dumbfounded at my own success. I tell you there wasn't a question on Radio I couldn't answer instantly and with perfect confidence. I was absolutely sure of myself. And as for building sets—well, I've just taken another order for a six-tube receiver. I shall make over a hundred dollars out of it. Is that reason enough for enthusiasm?

Now the above is a true story. Just think—Bob Carter was below average—yet, he became a real authority. If he could achieve such wonderful results in such a surprisingly short time, and with such ease—think what YOU could do! Yes—you can do better than Bob Carter. It doesn't make a jot of difference whether you've been a radio bug for years or whether you're an absolute beginner. In his new book "Radio Frequency Amplification" Kenneth Harkness will lead you step by step from the elementary principles to the most advanced aspects of modern radio reception. Just a few minutes a day with this book and you will be the authority among your friends. There won't be a thing that'll stump you—not a question you can't answer.

With the aid of this book you will know how to construct the most up-to-date receivers—superior to any of the commercial sets made today. The assembly and wiring of several different types are explained thoroughly and illustrated by scores and scores of diagrams, drawings and action photographs. Could anything be simpler? Yet remember—you will be taught the most advanced and modern developments, you will be told professional engineering secrets of manufacture never before revealed to the amateur radio constructor.

### SPECIAL LOW-PRICE QUICK ACTION OFFER

"Radio Frequency Amplification" with its handsome red binding, its eight meaty lessons on theory and seven closely knit lessons on intensive practice has met with an instantaneous, smashing demand! So we cannot urge you too strongly to send for your copy today before the edition runs out. To induce quick action on your part, the senders of the first five hundred coupons will receive this wonderful new book AND "Super-Regenerative Receivers" by the same author—both books for the astonishingly low price of only \$1.50!

### SEND NO MONEY

Simply fill in and mail the coupon below—when the books arrive pay the postman only \$1.50 plus a few cents postage.



THE RADIO GUILD, Inc.,  
256 West 34th Street, New York, N. Y.

Please rush me my copy of the new book "Radio Frequency Amplification" by Kenneth Harkness. I understand you will send me "Super-Regenerative Receivers" by the same author as a special inducement. When the postman arrives I will pay him only \$1.50 plus a few cents postage. (Outside U. S. \$1.75 cash with order).

Name .....  
Full Address .....

R-N-N

# A NEW FROST-FONE

*with bakelite shells and caps*



No. 172  
3200 Ohms  
**\$6<sup>00</sup>**  
[Genuine Bakelite]

**R**ICHLY beautiful—wonderfully sensitive—highest quality throughout—are these new No. 172 FROST-FONES with genuine maroon bakelite shells and caps. They embody new principles of construction, eliminating lead wires. Have moulded-in terminal block. Shells and caps are highly polished. Easily the most beautiful and finest head-fone on the market.

## FROST-RADIO

now includes the new No. 172 bakelite FROST-FONES, the new Nos. 161 and 171 aluminum shell FROST-FONES and FROST-RADIO Tube Sockets, Rheostats, Potentiometers, Switches and Dials, all of highest quality yet priced right because of tremendous production.

**Order Them From Your Dealer Today**  
Your dealer handles FROST-RADIO and can supply you with these new items. Call and see them today, ordering the parts needed for your set. The FROST-RADIO guarantee is your protection.

# HERBERT H. FROST, Inc.

154 WEST LAKE STREET, CHICAGO, ILLINOIS.  
30 Church Street, New York

*Makers of the famous Frost-Fones*

antagonize the "Ham." One can hardly blame fellows for refusing to help a BCL when the BCL has gone around the neighborhood calling him names or trying to cut down his aerial. What I have stated above are facts.

On the other hand I have worked hours, when a fellow has treated me decently, helping him hook up his set or erect an antenna. Many have asked me what to buy and I helped them to the best of my knowledge and I know that many other amateurs have done the same. And the ones who helped are not bothered with amateur interference and still they hear "DX." I am not trying to boast but any one with the beginning of a brain surely ought to learn in nine years what a fair set consists of.

The whole trouble seems to lie with the dealer who sells sets to make money at the same time and does not think of re-sales and in the city which I live in, there are many such dealers who take advantage of people who know nothing or at the most, very little of Radio.

Every time that I pass such a store I see red and I had to get this off before I did something rash but surely the public will awaken and then—

BEST 73's.  
9ABF.

## It's Great to Be One of 'Em

(Continued from page 527)

Mr. Commagere's early attempts at radio are clearly depicted in the historical photograph which also include his honorable countenance—being at that time but 12 years of age. Mr. Commagere is today in charge of the largest wireless plant owned and operated by the United Fruit Company.

I could go on citing amateurs who have gone right ahead climbing the ladder of success because of their devotion to the art, but space will not even permit me to make mention of only a few of those who reside in my immediate vicinity.

The radio field is expanding rapidly and room is being made every day for new men. This is the great opportunity which lies ahead of the Radio Amateur. He knows that the field is a large one and that it is growing, growing, growing, and that if he properly applies himself and studies, he can make his way to the laboratory bench, the ships, high power radio centrals, or most anything he makes up his mind he wants.

The Amateur of today must necessarily be of assistance to those who are entering the radio game primarily for the interception of broadcast music, news, etc., etc. In the earlier years, before it was possible to commercialize the radiophone, radio was left to the amateur and was looked upon by many as a "mystical agent" of some unknown force. Of course an amateur was considered a young Edison, and most of them were, for much was done by amateurs to advance radio to its present state.

The amateur of today begins his radio career on an entirely different basis—he can install both receiving and transmitting apparatus capable of communicating thousands of miles at a reasonable expenditure of both money and energy. There are numerous good books and magazines treating exclusively the subject of radio and it requires but a very short period of study in order to fully understand the fundamentals. However, in order to master the subject, years of study and practice are essential.

His debut in the Commercial field is generally marked by a position aboard ship as assistant operator where he has an opportunity to grasp some of the knowledge of his Chief.

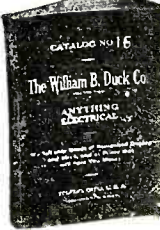

**DUCK'S**

Big 256 Page No. 16 Radio Catalog mailed for 25c. in coin. The largest radio catalog published. Special prices on many radio items. Prompt service, or money refunded. Ever since the year 1909 Duck's catalog has always occupied the foremost position among radio catalogs. All radio books in catalog, except book on page 62 of our own publication, at half price,—actually less than jobber's cost. Duck Bakelite knob and dial, 40c.; Navy Type Transformer \$12.00; Jr. Loose Coupler \$4.00; 3 ft. lengths highest grade spaghetti, 15c.

**NOTE.**—Our new location and internal changes give us admirable facilities to serve you promptly.

**THE WILLIAM B. DUCK CO.**  
Dept. 3, 711-12 ADAMS ST., TOLEDO, OHIO



**Ear-Joy**

\$1.00 Pair

**HEAD PHONE CUSHION**

HUDSON-ROSS

123 WEST MADISON ST., CHICAGO

**WANTED**—Back numbers of Radio News, Dec., 1921, Jan. and Feb., March and April-May, 1922. Experimenter Publishing Co., 53 Park Place, New York City.

On a railroad, mechanical perfection in a switch is a matter of life and death.

In a radio circuit the safe passage of electricity is equally dependent upon the quality of the switches.

Nothing will kill a weak signal quicker than a faulty switch.

Mar-Co Switches can be depended upon to safely direct electrical energy without loss in transit.

Your dealer sells them.

### MARTIN-COPELAND CO.

PROVIDENCE, R. I., U. S. A.

*Branches: New York, Chicago, San Francisco*



Panel Pull Switch  
for Filament  
Battery 90c



Panel Double Pole  
Double Throw Switches  
A and B Battery \$1.25



Panel Inductance Switches  
5 to 19 Point  
Lock Action \$1.00 to \$2.00



Knife Switches  
60c to \$1.50

# "American Beauty"

## Electric Soldering Iron



The Best Iron Made

For Soldering all connections, parts, etc. Ready for use by attaching to any electric light socket. The cost of operation is insignificant.

Many thousands in use by amateurs, engineers, manufacturers, telephone companies and many others.

For radio, telephone and all light work our latest Model No. 3138 is ideal; also two larger sizes for doing heavier work.

For twenty-eight years our name and trade mark have been a guarantee of quality and dependability.

**AMERICAN ELECTRICAL HEATER COMPANY**  
DETROIT, U. S. A.

Oldest and largest exclusive makers. Established 1894

### BROWNLIE'S CRYSTAL

A Natural Mineral Detector for Reflex or Crystal Sets. Sensitive over the Entire Surface.

Indorsed and Used by Leading Manufacturers of Radio Apparatus.

No Fishing for Contacts. All Points Work. Nothing Like It.

Stands Up Under Severe Plate Voltage

**MOUNTED AND GUARANTEED 50c.**

This is the Best Crystal ever Produced in our 14 Years of Crystal Making

Order from Your Dealer or Sent Direct.

**ROLAND BROWNLIE, Manuf'r**  
22-24 Saunders Street Medford, Mass.

### Rainbow Multi-Plug & Cable



Put this type on your new set it is small and may be mounted anywhere with cord and plug \$4.00 Type P.M.

Put this type on seven binding posts of your present set. With cord and plug \$5.00 Type B.P.



Put your Batteries on shelf in basement and run this 8 ft. cable through floor to set.

5A and B. Battery wires in cable. Antenna and ground are separate leads from cap. Guaranteed not to impair efficiency of set. For sale by all Jobbers and Dealers. Fully covered by patents applied for. Manufactured by **HOWARD B. JONES** Chicago, Ill. 608 S. Canal St.

Aboard ship there is a lot of time to study and that time should be made to account for itself. A correspondence course in Electrical Engineering or any other subject can easily be taken care of. Sooner or later he is transferred to a land station, either coastal or high power (trans-oceanic) and from that position has the opportunity of working himself to the head of the entire organization. Too many prefer to remain aboard ship for a greater portion of their lives, not realizing in a broad way just what this field offers them in the way of a better livelihood.

There are, of course, numerous amateurs who make Radio their hobby; many of these are very serious about it and while engaged in other fields have fairly well mastered the subject. Likewise, we have a great number of broadcast listeners who will eventually join our great rank of amateurs; probably on the same basis, with no desire to become actively engaged in the commercial field.

The amateur who is vitally interested in popularizing AMATEUR RADIO is going to do everything in his power to sell his idea of fairness to the Broadcast Listeners and not antagonize or criticize them. In numbers, they fairly well push us off the map, and that is something to think about. Let all of us make up our minds to pitch in and assist as much as possible, our new friends, the BCL's. This can be accomplished in numerous ways.

1. By keeping our transmitters quiet between the hours of 8 and 10:30 P.M.
2. Answering, in a courteous way, all their seemingly foolish questions.
3. Investigate, if called upon, trouble in their receiving equipments.
4. Improve our transmitters so that they do not interfere after the clock has struck 10:30 P.M. and it is permissible to transmit.
5. Invite the BCL to our club meetings so that he can get better acquainted with your aims.
6. If you think his trouble is due to his inability to tune, give him a few lessons in tuning.

### New Radio Patents

(Continued from page 561)

same time transformed and amplified. The changes in the intensity of this alternating current may then be observed by well known means, such as an ordinary telephone. The sound of the local alternating current source may then be heard corresponding to the signal received.

In accordance with the present invention, a

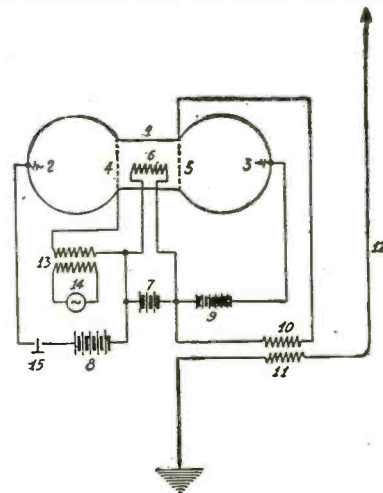

particularly advantageous arrangement consists in that the cathode relay is a tube having two anodes and two amplifying grids, whereby one grid is operated by the incoming high frequency, and the other by the alternating current. The drawing represents an exemplification of such an arrangement.

Insure your copy reaching you each month. Subscribe to Radio News—\$2.50 a year. Experimenter Publishing Co., 53 Park Place, N. Y. C.

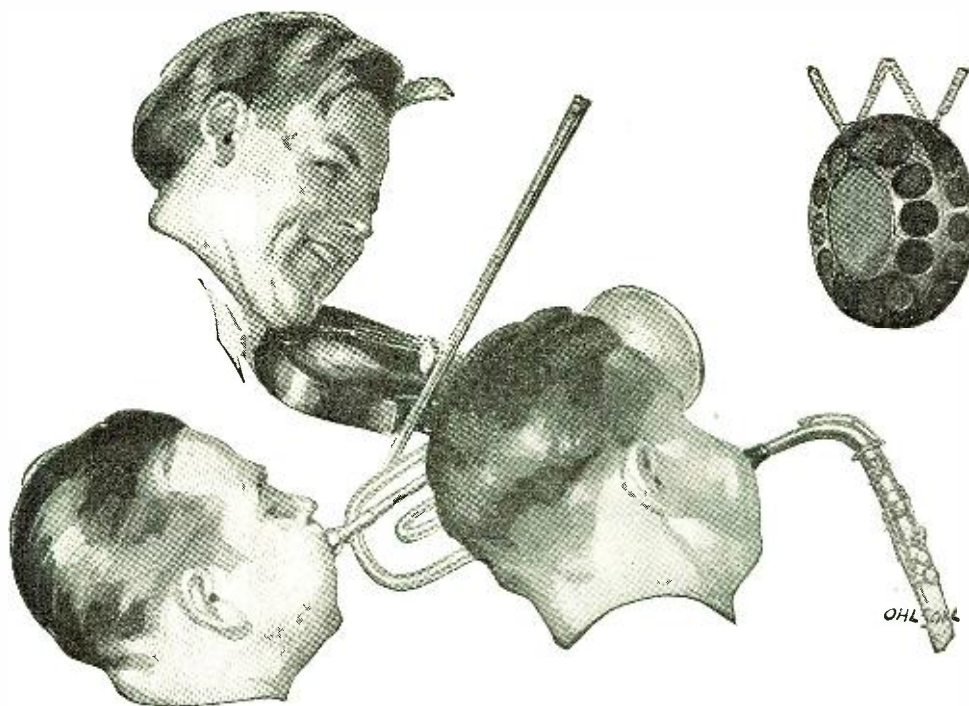

# Broadcasting Experts Agree

Talk to the radio engineers in the 51 broadcasting stations listed at the right — if you want to know why Willard Rechargeable B Batteries will improve your receiving set.

They use them to make their broadcasting more clear and distinct — and you will get the same results by using them with your set.

*They cut out noises* due to electrical leakage, internal action or too low voltage.

*They hold their voltage* for months without recharging and can be kept right up to full efficiency.

*They reduce expense* because they don't have to be replaced — just recharged at long intervals.

*Always brand new and ready for use* — Because they are shipped fully charged and bone dry. Don't deteriorate in stock. Ready for service instantly.

Willard A and B Rechargeable Radio Batteries are sold by Willard Service Stations and Radio Dealers everywhere.

Ask your dealer for the free book, "Better Results from Radio," or write to Willard Storage Battery Co., Cleveland, O.

## These 51 Broadcasting Stations Use Them

- |  |                                    |
|--|------------------------------------|
| WJAX and WHK<br>Cleveland, O.                | WDAE and WMAQ<br>Tampa, Florida    |
| WWJ and WCX<br>Detroit, Mich.                | WDAP<br>Chicago, Ill.              |
| WDAF and WHD<br>Kansas City, Mo.             | KLZ & AA-3<br>Denver, Colo.        |
| KSD<br>St. Louis, Mo.                        | WJH and WCAP<br>Washington, D. C.  |
| WSB and WGM<br>Atlanta, Ga.                  | WWI<br>Dearborn, Mich.             |
| WBAP<br>Ft. Worth, Texas                     | WHAM and WABA<br>Rochester, N. Y.  |
| WDAO and WFAA<br>Dallas, Texas               | WDAL<br>Jacksonville, Fla.         |
| WAAW, WOAW, and<br>WIAK<br>Omaha, Neb.       | WQAM<br>Miami, Fla.                |
| WEV and WCAK<br>Houston, Texas               | WMC<br>Memphis, Tenn.              |
| WCAG<br>New Orleans, La.                     | WOAI<br>San Antonio, Texas         |
| WOC<br>Davenport, Ia.                        | KZN & KDYL<br>Salt Lake City, Utah |
| WHA<br>Madison, Wisc.                        | KFCK<br>Colo. Springs, Colo.       |
| WGF<br>Des Moines, Ia.                       | WSY<br>Birmingham, Ala.            |
| WBAB<br>Minneapolis, Minn.                   | WLW and WSAI<br>Cincinnati, Ohio   |
| WHAZ<br>Troy, N. Y.                          | KGW<br>Portland, Ore.              |
| WJAR, WTAG, and<br>WEAN<br>Providence, R. I. | WNAR<br>Butler, Mo.                |
|  | KFI<br>Los Angeles, Calif.         |
|  | CFCA<br>Toronto, Ont.              |
|  | WGAR<br>Shreveport, La.            |

**A**

Good A Batteries are as important as good B Batteries. There are several types of Willard A Batteries at a range of prices, including the Willard All-Rubber A Battery, with rubber case and Threaded Rubber Insulation. Five sizes, 20 to 125 a. h.



# Willard Rechargeable Batteries for Radio



**B**

Willard Rechargeable B Batteries are made in 24 volt or 48 volt units, each type in two capacities, 2500 and 4500 m. a. h. Glass jars enable you to see the condition of your battery at all times and help prevent electrical leakage.



# The Right Way to keep Your "A" Battery fully charged

THIS thing of having your acid battery stuck under a table and hooking onto it a portable charger when poor reception warns you that it is time to do so, is *all wrong*.

If Radio means anything in your home and social life, it is worth attending to properly—in an orderly manner.

Your A battery should be permanently installed in basement or closet, and a

## Leich Non-Tune Rectifier Connected to it Properly

Then every night, just as regularly as you lock doors and windows, fix the furnace or wind your watch, you should push the switch that starts the Rectifier on its job of recharging the battery.

Its rate of charge (2 amperes) and its non-tune self-protecting features prevent any reverse discharge of battery, should current be interrupted.

Then, when you arise in the morning, disconnecting the Rectifier will become just as much a matter of *habit* as dressing, shaving, or hunting up the morning paper.

A battery thus systematically recharged will last longer, and give you more uniformly efficient service.

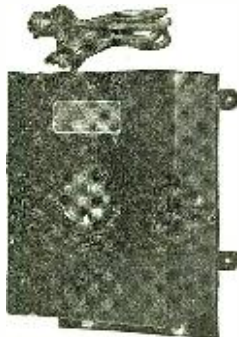

No. 16 Non-Tune Radio Rectifier. Price \$19.00

### HEADPHONE PLUG



L'-Radio Two Phone Series Plug No. 61

Price \$1.00



Leich Comfortable Headphone 1-B-2000 Ohm

\$6.00

Send for the Rectifier and Radio Bulletin 101-F

LEICH ELECTRIC CO. GENOA, ILL.

1 is a cathode relay having two anodes 2, 3 and two auxiliary anodes (amplifying grids) 4 and 5. 6 is a glowing cathode, which is heated by the battery 7. 8 is a battery provided between anode 2 and cathode 6, whereas the battery 9 is provided between cathode 6 and anode 3. Preferably, the voltage of battery 9 is higher than that of battery 8. By means of coil 10 connected with coil 11 and antenna 12, the received high frequency oscillations may be conducted and the tube 1, whereby the resistance for path 6, 5 and 3, will be increased. The electrons flowing towards anode 3 are partially reflected and find a lower resistance in the path 6, 4, 2. At 4 these electrons or ions are affected by the local alternating current of audible frequency which flows from machine 14 through transformer 13, and the amplification is effected in the well known manner. In view of the fact that all vibrations result in a flow of electrons, the received signals may be heard in telephone 15, and have always the tone of the auxiliary frequency of the machine 14. Obviously, it is not necessary directly to connect the telephone 15, with the line, but the connection may be effected also through a transformer.

The continuous tone provided by machine 14, which under certain circumstances may interfere with the intelligibility of the signals, may be eliminated by means of well known compensating connections.

### APPARATUS FOR THE RECEIPT OF WIRELESS IMPULSES

(Patent No. 1,456,867. Issued to Frank Conrad, of Pittsburgh, Pa., May 29, 1923)

This invention relates to apparatus for the receipt of wireless impulses and it has for its object to provide apparatus of the character designated that shall enable one to distantly control relays or other forms of electrical apparatus by means of wireless impulses and, at the same time, to substantially prevent the operation of such apparatus by other than the impulses intended therefor.

Fig. 1 of the accompanying drawing is a diagrammatic view of a system embodying the invention, being shown for the wireless control of a distant relay; Fig. 2 is a diagrammatic view of a modified form of relay that may be used in the system of Fig. 1.

It is frequently desirable to control apparatus at a distance by wireless impulses, as, for example, in the wireless control of torpedoes. In

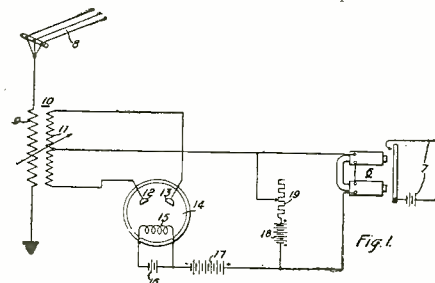

the past, difficulty has been encountered in obtaining a clear and distinct receipt of the transmitted impulses, particularly under adverse circumstances, as where hostile forces are filling the ether with impulses of various wave-lengths and group frequencies for the specific purpose of preventing the wireless control of torpedoes and similar apparatus.

Very effective control of relays or similar apparatus may be secured by providing a hot-cathode tube in the electrical connection to the relay to be controlled and by continuously supplying to said tube an electromotive force slightly below its critical voltage. The incoming impulses are then superimposed upon the electromotive force in the form of transient voltage increments, the resultant voltage being sufficient to pass, above the critical voltage of the tube, permitting the passage of relatively large amounts of cur-

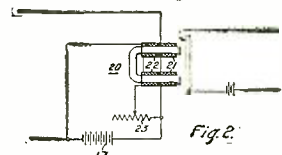

rent therethrough and to the relay to be controlled.

With a system of this character, it will be obvious that there is a tendency to pass a small amount of current through the relay at all times but by shunting the relay with an auxiliary source of electromotive force, the potential conditions of the circuit may be so adjusted that no current flow whatsoever takes place through the relay except when impulses are being received upon the antenna.

In order to render an impulse-receiving system of this character highly selective, it is desirable to dynamically interlink the relay with the antenna through two local circuits, one of which is tuned to resonate to the radio frequency and the other of which is tuned to resonate to the spark or group frequency.

Under these conditions, it is substantially im-

### LOUD SPEAKING CRYSTAL SET

At Last



You can add a loud speaker to any crystal set by using the STEINMETZ Amplifier costing only \$8.50. Guaranteed to operate on any kind of crystal set regardless of what type it is, or we will refund your money.

By using your crystal set with this amplifier music is brought in as clear as a bell and can be heard all over the room. Amplifier uses dry cell tube. Write for our complete catalog and also information on a highly efficient detector and two-stage amplifier at \$22.50.

STEINMETZ WIRELESS MFG. CO. Manufacturers and Engineers 5705 Penn Ave. Pittsburgh, Pa.

### RADIO CABINETS

Made to Order. Write for prices.

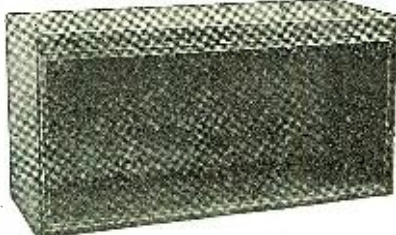

YOUNG MFG. CO., Beloit, Wis.

WANTED—Back numbers of Radio News, Dec., 1921, Jan. and Feb., March and April-May, 1922. Experimenter Publishing Co., 53 Park Place, New York City.



## MAGNAVOX Products

EVERY condition in the art of radio reproduction is most successfully met by Magnavox apparatus.

### Reproducers

R2 with 18 inch horn . . . \$60.00

R3 with 14 inch horn . . . \$35.00

M1 with 14 inch horn; for dry battery sets . \$35.00

### Combination Sets

A1-R consists of Magnavox Reproducer with 14 inch horn and 1-stage Amplifier . . . \$59.00

A2-R same with 2-stage Amplifier . . . \$85.00

### Power Amplifiers

A1-One-stage . . . 27.50

AC-2-C-Two-stage 55.00

AC-3-C-Three-stage 75.00

Radio users will be sent new 32-page Magnavox Radio Catalogue on request.



The new Magnavox Combination Sets A2-R [2-stage] and A1-R [1-stage] insure the utmost in convenient, perfect home radio reproduction.

A special device permits instant control of volume to suit the size of room, character of program, etc.

## Current Events by Magnavox Radio

TODAY, an education comes to stand for growth, the schoolroom is no longer the student's world, but the world is the student's schoolroom—and we are all students.

A Magnavox in the home means a liberal education and daily entertainment for old and young.

For the requirements of those who own dry battery receiving sets, the new Magnavox

Reproducer M1 (semi-dynamic type) is supreme in its class. Where storage battery sets are used, the new Magnavox Combination Sets (as illustrated) give the utmost in appearance, adaptability and efficiency.

Magnavox Products are for sale by Registered Magnavox Dealers Everywhere

THE MAGNAVOX COMPANY, Oakland, Calif.

New York Office, 370 Seventh Avenue  
Perkins Electric Co., Ltd., Canadian Distributors

# MAGNAVOX PRODUCTS

There is a Magnavox for every receiving set

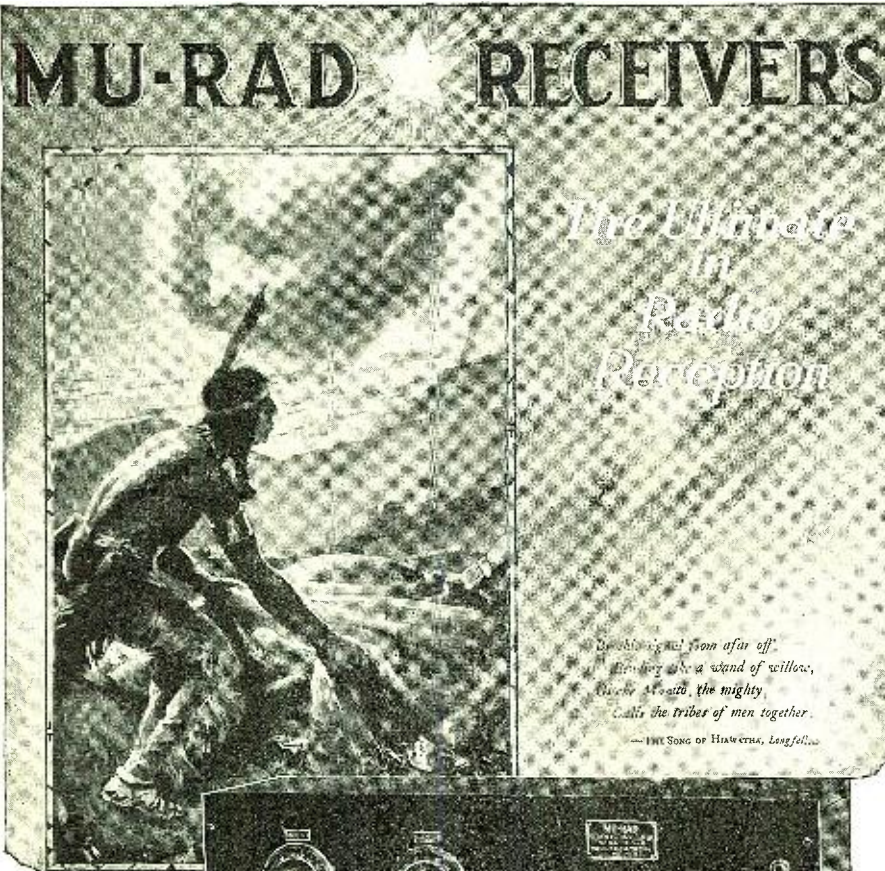

The New  
Star in  
the Radio  
World



**GIFTS FROM THE GREAT SPIRIT**" said Iron Hawk, the famous Sioux chief, of the Indians' means of communication. The final perfection of this great gift to mankind is radio. The new science attains its *ultimate* in MU-RAD RECEIVERS. The MU-RAD owner lives in close touch with a vast radius of 4300 miles and more. Time is eliminated. Distance is only geographical. Reception conservatively guaranteed—1000 miles, using only a 2 foot loop aerial.

WRITE FOR LITERATURE

**MU-RAD LABORATORIES, INC.**  
801 FIFTH AVE. ASBURY PARK, NEW JERSEY

The Ultimate  
in  
Radio  
Reception

"Double signal from afar off"  
"They are a band of willow,  
"Such a voice, the mighty,  
"Calls the tribes of men together."  
— THE SONG OF HAWKES, Longfellow

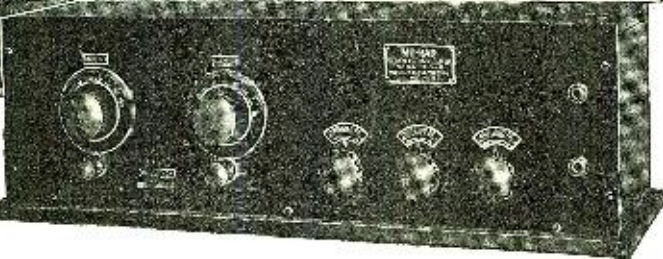

**IT HAS HAPPENED TO ALL OF YOU IN A FRACTION OF A SECOND!**

WHEN the filament burns out, at least \$5.00 goes with it to put the set in operation again.

WHY not save nearly one-half the cost of a new tube by sending us your burned out or broken tube to be repaired?

WE REPAIR EVERY TYPE of tungsten wire filament receiving tube. All our tubes are TESTED and GUARANTEED to function as well as when new.

All tubes returned P.P., C.O.D.

**HARVARD RADIO LABORATORIES**  
BOSTON P. O. BOX 1781 MASS.

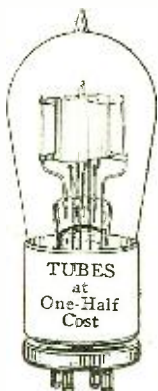

TUBES  
at  
One-Half  
Cost

possible for the enemy to deflect the approaching torpedo by sending out impulses from his own station, as it is necessary not only that he employ the same wave-length or radio frequency but that he simultaneously employ the same spark or group frequency and that the spark or group frequency impulses be substantially in synchronism with the impulses from the station controlling the torpedo.

**What Uncle Sam Is Doing for the Amateur**

(Continued from page 525)

American Radio Relay League. Thus in the event of an emergency and in case of a disruption of the commercial communication systems, the amateur stations would handle the traffic for both Government departments and private individuals between all parts of the United States by radio. While in this instance, the radio amateur would be helping the Government, it further indicates the unity of interests of the two forces and establishes the reality of the title of this article "What Uncle Same is Doing for the Amateur."

**My Moduloscope**

(Continued from page 549)

Picture No. 5 has the secondary of a 1/4-K.W. 5000-volt Thordarson transformer placed in series with the positive lead of the supply from the rectifier in addition to the 2-mfd. condenser.

Picture No. 6 has the above, plus two more 1-mfd. condensers on the other side of the choke in the supply from the rectifier.

Picture No. 7 shows result of taking pictures with not enough time exposure.

As the light ring continues to close its dark gaps the modulation of the carrier wave is being modified to the point where it becomes D.C. current at the plate of the tube and pure D.C. C.W. in the antenna. This is a feature very much desired at this time under the new regulations governing wave-lengths and at so small an expense that it cannot be considered left out in the equipment of our amateur transmitters. Since its development I have found it possible to connect the moduloscope directly to the antenna connection of the trans-

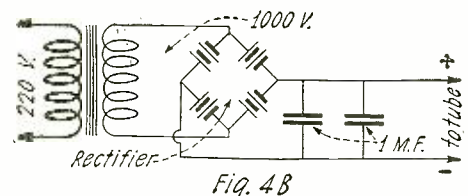
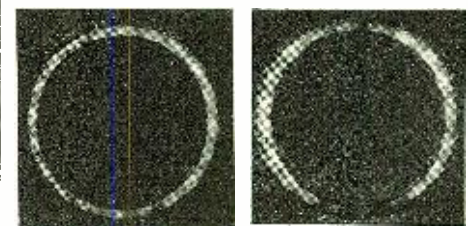
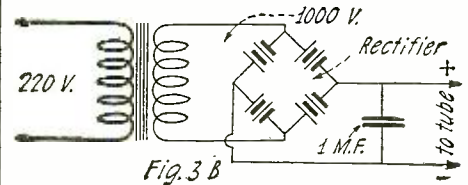

By Shunting First One, Then Two Large Capacity Condensers Across the High Tension Leads, the Effective Filtration of the A.C. is Increased. No Actual Breaks Are Apparent in the Moduloscope Photos.

# SUPER-HETERODYNE

## The World's Best Radio Receiver

BY PERFORMANCE

### ADVANTAGES NO OTHER RECEIVER CAN EQUAL

- 1. UNIFORM EFFICIENCY** over the entire wavelength range of 160 to 850 meters. This means that all stations, Radio-telephone Broadcasting, Amateur and Commercial within this wavelength range, will be received with maximum intensity. This very desirable feature is not obtainable by any other practical method using Radio Frequency amplification.
- 2. SELECTIVITY** by this system, greatly exceeds that obtained in all other methods of reception. Using the Model "C" with a loop in the Suburbs of New York, WOR 15 miles distance, operating on 405 meters, can be completely eliminated, and PWX 1300 miles distance operating on 400, can be received on a loud speaker. This holds true on an average cool night. There is no telegraphic interference from 200 meter amateur stations or 600 meter ship stations.
- 3. SIMPLICITY** to change from one station to another, there are only two dials to vary. The two dials can be calibrated for all the various stations, as there is only one best position for each station.
- 4. AMPLIFICATION** is much greater than obtainable in any other standard receiver. Total is as follows: 1st the Heterodyne Amplification in the 1st Detector; 2nd, the Regenerative Amplification in the 1st Detector; 3rd the 3 stages of Tuned Regenerative Radio Frequency Amplification; working at a low advantageous frequency; 4th, the second Detector action, and 5th, the two stages of low ratio distortionless audio frequency amplification.
- 5. RECEIVING RANGE** other factors correct, the receiving range is in proportion to the effective radio frequency amplification applied. As this receiver has much greater effective radio frequency amplification than all others, the range is proportionally greater.

Complete Constructional Blue Prints Consisting of Two Sheets 50x21" and Two Sheets 27x21" and Two Sheets 30141-145. \$2.00 Postpaid.

Designers of the Highest Class Radio Apparatus in the World

# Experimenters Information Service

531 West 46th Street

New York City



"THE ROLLS-ROYCE OF RECEPTION"



### MODEL "C" SUPER-HETERODYNE

Wavelength Range 160 to 850 meters. Tubes, 2 Detectors, Oscillator, 3 Tuned Radio Freq. Amplifiers, 2 Audio Amplifiers.

The Super-Heterodyne is the most efficient method of short wave radio frequency amplification known. It is used extensively by the Commercial radio companies and various governments, when it is necessary to receive over extremely long distances, without interference from near-by stations. The remarkable results are due to the Super-Heterodyne action, which is briefly as follows: the incoming signal, which may be any wave from 160 to 850, is changed thru the use of a local oscillator, to a wavelength of 10,000 meters. At this wavelength an exact duplicate of the original signal is amplified at radio frequency with the very highest efficiency possible, rectified and amplified at audio frequency.

During this change a very high degree of selectivity is secured, due to the amplifier, which is designed to pass nothing but 10,000 meters. Accordingly while there may be ten or more signals in the loop, only one will be received at a time, the one that the oscillator heterodynes thru the amplifier.

# RADAK R4

## Complete Regenerative Receiver

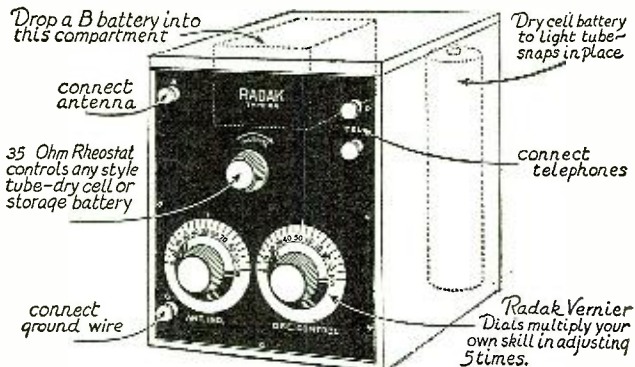

Licensed under Armstrong U. S. Patent 1,113,149

PRICE \$25.00

A newly designed and thoroughly tested circuit of superior capability, solid mahogany cabinet, genuine Formica panel, remarkable Radak Vernier dials, all batteries inside the cabinet with overall size of but 6 x 8 x 10 inches.

Where else will you find these earmarks of quality in a set selling for \$25.00? The new Radak "Governing Capacity" controls regeneration with surprising ease. Radak R4 is a self-contained set designed for use on dry cells and operating over a range of wave-lengths of 225 to 550 meters. Wherever you are, or wherever you go, you can take this set with you. Merely slip in a flashlight battery, a small "B" battery and a 3-volt vacuum tube, connect to a wire hung out the window, thrown over the limb of a tree or even laid on the roof if no antenna is available, and programs from considerable and often surprising distances may be received in a few minutes from the time you start. While easily carried to your summer home, camp, or on your vacation, the R4 is in no sense a portable or makeshift outfit, but its high quality of finish and workmanship will grace the most refined surroundings.

R4 Set complete, as illustrated and described, without accessories .....\$25.00

A4 RADAK 2 STAGE AMPLIFIER EXACTLY MATCHES THE ABOVE SET.....\$25.00

From the R4 at \$25.00 to the C64 five tube radio frequency set at \$220.00 THE BASIS OF RADAK SUPREMACY lies in the fact that Radak sets are an engineered entity not a mere assembly of parts. Complete bulletin of all models sent on request.

Manufactured by

**CLAPP-EASTHAM COMPANY**

107 MAIN STREET, CAMBRIDGE, MASS.

New York, N. Y.  
395 Broadway

Cleveland, Ohio  
Caxton Bldg.

San Francisco, Cal.  
709 Mission St.

## TO THE RADIO DEALER.

Let us explain how you can make the sale of our publications a worth while, well paying part of your business. Every one that enters your store is a prospective buyer of RADIO NEWS. RADIO NEWS will sell with little effort on your part.

You may sell our publications on a single copy basis with a fine margin of profit or on a subscription basis with a generous commission allowance.

Write now and prepare for the Fall and Winter trade.

**EXPERIMENTER PUBLISHING CO.,**  
53 Park Place, New York.

mitting set without disturbing the transmission going on at the time.

### MAKING THE MODULOSCOPE

Procure a cardboard mailing tube, any diameter between 2", 3½" and 12" long. Wind this full with a single layer of No. 24 B & S gauge and carefully boil the whole in new, clean paraffin to force out any moisture. Be careful not to raise the paraffin to such a temperature that it emits smoke. Let the tube cook and place on a wooden block base. Finish the top off with a half sphere of wood, which should be dry or boiled in wax. Place a terminal at each end of the winding, connect 3" of No. 14 wire to the top end and solder a 2" piece of No. 24 to the end of the No. 14 wire. Bend it into a short hook with a complete small circle at its end to prevent corona discharge. Then take a piece of No. 24 wire 5" long and bend into the shape of a figure "8" with a loop at its center which will fit over the No. 24 at the end of the No. 14 wire. Carefully balance the figure "8" wire until you can spin it freely and have it come to rest at no given point. Con-

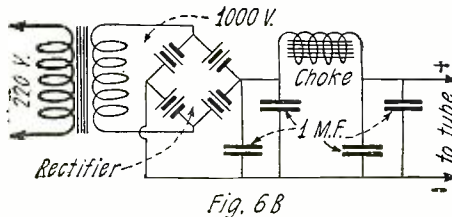
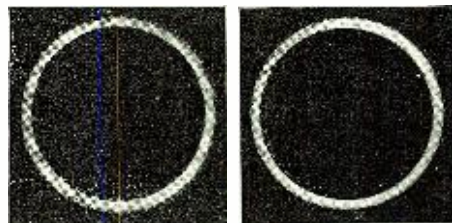
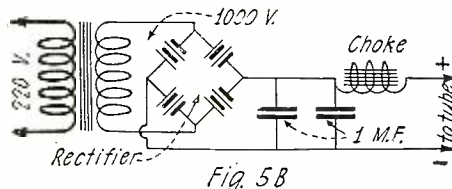

The Addition of a Choke as in Fig. 5B Improves the Filtration. With Two More Shunt Capacities on the Other Side of the Choke as in Fig. 6B a Pure Current is Obtained with No Visual Ripples or Irregularities.

nect the lower terminal to the antenna terminal of your transmitter (you may have to retune the transmitter a trifle), press the key and take note of the carrier wave modulation. Aside from its evident usefulness as

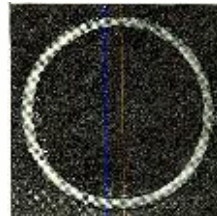

The Result of a Moduloscope Photo Not Having Had Enough Time Exposure

a moduloscope it will entertain you for hours at a time, particularly in the evening with the lights out, when it presents quite a spectacle.

If the presentation of the article has been to your liking, I will write next about a way and means to make use of the moduloscope as a transmitter without the use of an outdoor antenna. In the meantime, I will converse with a good many of you via the air and hope that Amateur Radio and its operators will continue to play the important and useful part in the work they are at present performing.

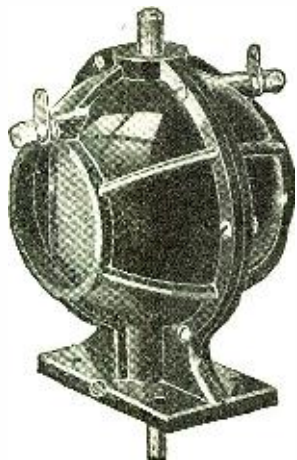

VARIOMETERS

Highest electrical efficiency. Made in 2 sizes of moulded brown bakelite, split bronze bearings. R 675—overall height—4 3/8". Diameter of hemispherical shell 3 3/4". Thickness over shell 3 3/4". Weight 10 oz. Wound for wave lengths approx. 150 to 500 meters. R 100—overall height 6 1/2". Diameter of hemispherical shell 5 1/4". Diameter of Rotor ball 4". Weight 1 lb. 5 oz. Wound for 150 to 700 meters approx. wave length receiving range.

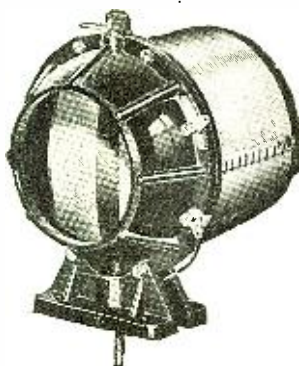

VARIOCOUPERS

None finer. Made in 2 sizes of moulded brown bakelite, split bronze bearings. Winding tapped at 15 points for very close tuning. R 650 Overall height 4 3/8". Dia. of hemispherical shell 3 3/8". Overall length 4 1/2". Weight 12 oz. Wound for approx. 150 to 500 meters. R 125 overall height 6 1/2". Dia. of hemispherical shell 5 1/4". Length overall—5 1/2". Weight 1 lb. 11 oz. Wound for 150 to 700 meters approx. wave length receiving range.

# “Okeh!—its made by Gilfillan”

The experienced radio fan needs no greater assurance of satisfactory service than the statement—“It’s a Gilfillan unit.”

Check up on sets built of Gilfillan Radio Parts, and you’ll find them giving the utmost satisfaction.

No matter what the part is, if it’s a *Gilfillan* you’re getting the *best*—and at a very reasonable price.

You’ll do well to inspect Gilfillan Radio Parts before making any selections. If your dealer does not handle Gilfillan, write for name of nearest dealer and descriptive parts folder.

*Every genuine Gilfillan Radio Part carries this mark—it’s your SEAL OF SERVICE—look for it.*



## G I L F I L L A N M A K E S

Variocouplers (2 sizes)	Audio Frequency Transformers	Tube Sockets	Vernier Air Condensers
Variometers (2 sizes)	Potentiometers	Tube Socket Adapters	Filament Rheostats
Condensers (2 sizes)	Primary Inductance Switches	Detector Amplifier Units	Vernier Rheostats
Air Condensers (3 sizes)	Panel Switches	Detector Units	Moulded Knobs, etc.

## GILFILLAN BROS., Inc.

1925 McGee St.,  
Kansas City, Mo.

1815 W. 16th St.,  
Los Angeles, Cal.

225 W. 57th St.,  
New York, N. Y.

Licenseses of General Bakelite Co.

# They Guide Uncle Sam



Dr. J. H. Dellinger, Chief

The two chiefs of the Radio Laboratory U. S. BUREAU OF STANDARDS



L. E. Whittemore, Alternate Chief

In the great radio laboratories of Uncle Sam's Bureau of Standards, are two engineers who guide and look after the public's interests in matters pertaining to radio. These men (Dr. Dellinger and Mr. Whittemore) are two of the foremost radio experts in the world. Suppose you had the opportunity to have these eminent radio experts guide you, too; to point out to you step by step what to do; and answer your questions when you are puzzled—would you not exercise that power to your advantage?

## Would you like to have them guide you too?

Just such an opportunity is yours in the LEFAX (perpetual) RADIO HANDBOOK, of which these two men are the authors. Virtually, it is an encyclopedia of radio information. It is the most thorough and complete book on the radio science—written in language everyone can understand. Owing to having been conceived by the two chiefs of the U. S. Bureau of Standards Radio Department, this work to-day is the guiding light in the field of radio litera-

ture—to it you can go for practically every kind of information; there you will find it stripped of technicalities, complete, non-sensational, authoritative. L. A. Warren, E.E., of Chicago, writes "My radio library contains over 70 volumes—almost everything published on radio during the past twelve years—and I have found your book the best, most useful, general all-round work so far."

## Lefax always tells the whole story about radio Never grows old

There is one reason above all, why the LEFAX (perpetual) RADIO HANDBOOK should be the infallible guide for you—no matter what new developments in radio transpire in the future, the LEFAX RADIO HANDBOOK will take them in. However startling and revolutionary the changes, LEFAX RADIO HANDBOOK will keep abreast of them, and tell you

the whole story about radio—to-morrow, in 1924, in 1927 and thereafter. LEFAX RADIO HANDBOOK is loose-leaf and every month you get additional pages that keep it up-to-date. These additional pages are the most reliable source of supplementary reference in the field of radio literature. The material that is contained in them has gone through a process of tests, and examinations, and analysis, that defies all rumors, sensationalism and theories. There is no repetition of the same matter in re-hashed form. The material published in this supplementary service is reliable—absolutely fit to supplement the most authoritative RADIO HANDBOOK.

### Service Enlarged Now

This service has just been enlarged. 48 additional pages on "hook-ups" new discoveries, etc., are sent to each purchaser of the LEFAX (perpetual) RADIO HANDBOOK—each month. No charge at all is made for this additional service for the first year. Price is \$5.00 complete with one year's service of additional pages every month for one year.

For sale at all good radio dealers and stationers everywhere.

LEFAX, INC., 147 S. 9th St., Phila., Pa

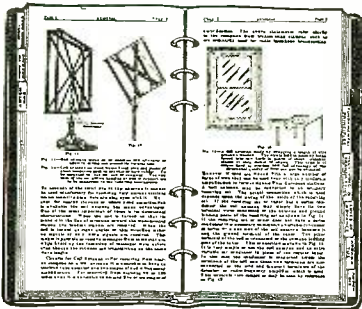

## The Amateur's Huge Gain from Broadcasting

(Continued from page 541.)

bunch of buzzes was coming from Virginia, and they said, "how wonderful" but they really meant the "h—you say!" Now, when Uncle Al comes to town and you tune in the championship fight returns from the ringside, round by round, he takes on a glad aspect as though he could see some practical value in the thing. And after all, old man, you know as well as I do that the real joy which comes from any possession is sharing it with others, and broadcasting has made this possible.

### IMPROVED APPARATUS

Years ago, when the head-chopping business was dull, they used an axe, but later the French Revolution stimulated the business tremendously and the guillotine was designed to take care of the increased business in an efficient manner and with less haggling and hacking than characterized the business theretofore. Manufacturers were loth to bring out new apparatus when business was dull and their shelves were loaded with obsolete equipment. Broadcasting opened a tremendous market, revived competition, quickly consumed the junk on the shelves, and paved the way for the many phenomenal advances in design of apparatus.

### MAKING SIDE MONEY FOR THE STATION'S UPKEEP

Not all amateurs were burdened with ready cash and it was sometimes a problem to obtain a few dollars for some addition to the station. How many amateurs assembled their old parts into receivers, sold them to broadcast listeners and then invested the receipts in a bunch of brand new stuff? Not to mention the many who engaged in the business, the majority of amateurs seized the opportunity to improve their equipment.

At the same time the amateur had not only more cash, but he eventually found better apparatus on the market at reduced prices. Of course there was the initial upheaval when junk mounted skywards and ordinary stuff sold at a premium over the counter. But today manufacturing facilities have reached the demand and even exceeded it, prices are lower and there is every prospect of reasonable prices in the future.

### PHENOMENAL ADVANCE IN RADIO

Every amateur is fundamentally an experimenter. In the years that preceded the broadcast upheaval many of these ingenious brethren had devised circuits of their own, little pet hook-ups that they had found efficient. Suddenly there was a demand for all this experience, for these pet circuits, for the knowledge obtained in experimenting with them. It suddenly became a matter of vital national interest.

For example, there had been trans-Continental relays, trans-Atlantic tests, etc., going on year after year. The amateur forged ahead slowly but surely, but no one really exhibited any interest in him or his works. How different it was with Godley and his test!

Through broadcasting and broadcast receiving, the great American public took an active interest in radio and in a short time Godley and his success were as well known in American homes as base-ball players, and better known than the Vice-president. It is a safe gamble that more Americans can name the inventor of the regenerative circuit than can name the Secretary of War. Before broadcasting, there were not a hundred thousand people in the United States who cared whether the energy was fed back into the grid circuit or the

# LEARN THE CODE AT HOME

"Just Listen—The Omnigraph will do the teaching"

with the

## OMNIGRAPH

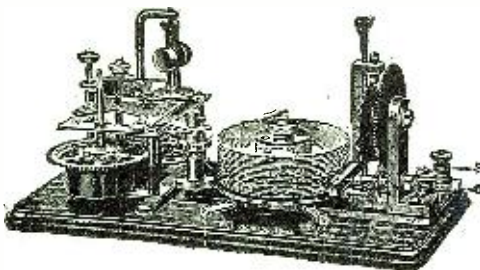

THE OMNIGRAPH Automatic Transmitter will teach you both the Wireless and Morse Codes—right in your own home—quickly, easily and inexpensively. Connected with Buzzer, Buzzer and Phone or to Sounder, it will send you unlimited messages, at any speed, from 5 to 50 words a minute.

THE OMNIGRAPH is not an experiment. For more than 15 years, it has been sold all over the world with a money back guarantee. The OMNIGRAPH is used by several Depts. of the U. S. Govt.

—in fact, the Dept. of Commerce, uses the OMNIGRAPH to test all applicants applying for a Radio license. The OMNIGRAPH has been successfully adopted by the leading Universities, Colleges and Radio Schools.

Send for FREE Catalog describing three models, \$14 to \$30. DO IT TODAY.

The Omnigraph Mfg. Co., 20 Hudson St., New York City

If you own a Radio Phone set and don't know the code—you are missing most of the fun

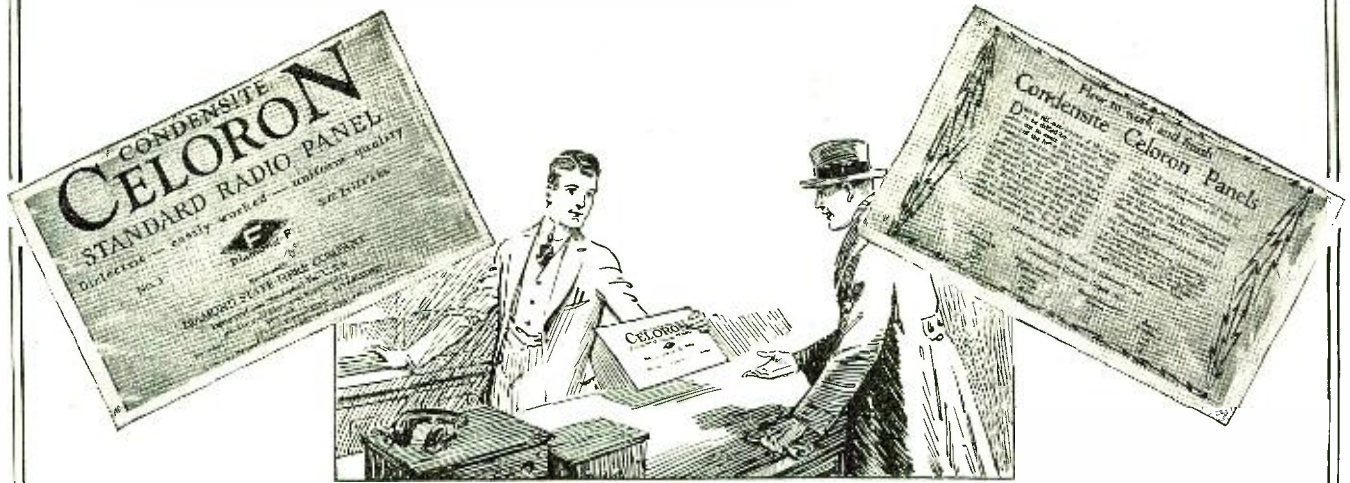

## Ask any radio expert

THE first duty of a radio panel is to give satisfactory insulation, as any radio expert will tell you. The wise fan selects his panel with special care and insists on having one that supplies the proper insulation resistance.

Celoron Radio Panels provide satisfactory insulation under all conditions. They have high dielectric strength and great surface and volume resistivity, and do not warp or crack when exposed to moisture.

### *Cut in standard sizes*

For your convenience, Celoron Radio Panels come ready cut in eight standard sizes. Your dealer will hand you the size you want, and you can begin to build your set at once.

Celoron panels are easy to saw, mill, and tap, and will engrave evenly without feathering. Each panel is wrapped separately in glassine paper.

Select from the following standard sizes the panel that suits your needs:

1—6 x 7 x $\frac{1}{8}$	5—7 x 18 x $\frac{3}{16}$
2—7 x 9 x $\frac{1}{8}$	6—7 x 21 x $\frac{3}{16}$
3—7 x 12 x $\frac{1}{8}$	7—7 x 24 x $\frac{3}{16}$
4—7 x 14 x $\frac{3}{16}$	8—12 x 18 x $\frac{3}{16}$

If your dealer cannot supply you, ask him to order, or write direct to us. Indicate by number the size you need. We also furnish Celoron in full-sized sheets and in tubes, and can cut panels in special sizes if desired.

### *This booklet free*

Write for a copy of our booklet, "Tuning in on a New World," which contains a list of the leading broadcasting stations in the United States and Canada, an explanation of symbols used in radio diagrams, and several efficient radio hook-ups. It will be sent to you free on request.

*To radio dealers: Send for special dealer price list showing standard assortments*

## Diamond State Fibre Company

BRIDGEPORT (near Philadelphia) PENNSYLVANIA

BRANCH FACTORIES AND WAREHOUSES  
BOSTON CHICAGO SAN FRANCISCO

Offices in Principal Cities

In Canada: Diamond State Fibre Company of Canada, Limited, 245 Carlaw Ave., Toronto

CONDENSITE  
**CELORON**  
STANDARD RADIO PANEL

# Branston D. L. Honeycomb Coils and Mountings

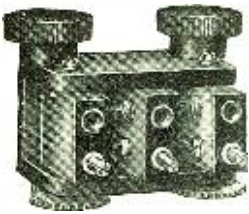

**R61. Three Coil Geared Mounting. Front Panel Type. \$5.30**  
Substantial gears give vernier adjustment. Very neat appearance. Made of Genuine Bakelite, complete with flexible leads.



**R62. Three Coil Bevel Geared Type. Back Panel Mounting. \$6.00**  
Bevel gears provide very smooth operation and vernier adjustment. Made of Genuine Bakelite, complete with flexible leads. Arrow knobs show position of coils.



**R73. Three Coil Bakelite Mounting. \$4.50**  
Neatest three coil mounting on the market. Made of Genuine Bakelite and complete with flexible leads.

Study these mountings carefully. Our new No. R61 3-coil front panel mounting and No. R62 rear panel mounting are equipped with strong brass nickel plated gears, insuring smooth vernier adjustment with no chance of stripping gears. Back geared type is equipped with arrow knobs that shows position of coils. Mountings are substantially constructed of genuine Bakelite and are equipped with flexible leads.

Branston D.L. Honeycomb coils are accepted as standard in regards to superior construction and electrical units of measurement. Your dealer can purchase Branston Coils and Mountings from his distributor. Invest on the Genuine.

Send 2c in stamps for Series 1 "Hook-Up" circular showing five good Honeycomb Coil Hook-Ups and Catalog of famous Branston Radio Apparatus. Write today. Give us name of your radio dealer. If he can't supply you, write

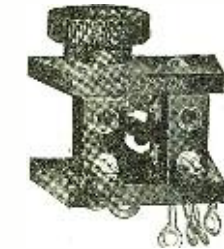

**R71. Two-coil Mounting. \$3.25**  
Very neat and capable of smooth operation. Only two mounting screws required. Complete with flexible leads.



**R77. Bakelite Coil Mounting. 50c**  
instead of screws for mounting.



**R68. Single Movable Bakelite Plug with extension angle brackets and flexible leads. 90c.**

**R69. Same as No. R68 only stationary. 90c.**



Add Miles and Smiles with

**CHAS. A. BRANSTON, Inc.**  
817 MAIN STREET, BUFFALO, N. Y.  
In Canada—Chas. A. Branston, Ltd., Toronto, Ont.

Branston Standard Radio Parts

garbage can. Tonight a million folks will be listening in on regenerative receivers.

### AMATEURS AS INVENTORS

Thus an enormous market was opened up. There was a time when nobody thought enough of Armstrong's circuit to pay the cost of taking out a patent. The situation has changed marvelously. Where there was once a shack frequented by a few operators, the public has now a well-worn path. Many, many amateurs have profited enormously by the broadcasting craze. Mr. Ham can now stand in front of his shack with his chest pushed out while the photographers "shoot" him for the many radio periodicals that flood the mails. He has become an inventor and ranks with the inventor of the cotton gin and other kinds. The public reads again and again the accounts of how he did it.

### WHEN THE AIR WAS FREE

Once there was a time when Mr. Amateur could open up and make the ether fairly reverberate with his terrific spark and no one cared, except Uncle Sam. The type of receiver was of no great consequence. The wave was as broad as a barn door and if you were nearby you could hear him by sticking your head out the window. Ambitious amateurs employed selective receivers and modern transmitters, but they were not essential to communication, therefore, no interest. Jamming the ether has made us selective. Modern transmitters and selective receivers are now essential to communication and the future will bring still greater progress. There is no place now for a transmitter that sprays the universe.

### LISTENING IN

The average amateur may not care three whoops in purgatory for all the canned music that was ever broadcast from Cannville. He may not care any more for the Symphony Orchestra than he does for a shower bath while wearing a paper shirt, and market quotations and educational lectures may move him to tears, but he does get in on the base ball returns and the elections. And what amateur does not enjoy listening to, "the challenger handed the champion a wallop on the chin that shook the arena and followed with another to the same place. The champion was slightly dazed but took the offensive. The champion rushed the challenger to the ropes with three uppercuts that forced the referee to swallow his chewing gum, etc., etc."? Surely there are times when any amateur enjoys broadcasting.

### HAS THE AMATEUR PROFITED?

The broadcasting craze has furnished funds for continued advancement; it has opened a great field for the amateur experimenter with rich rewards; it honors him, where only a few fellow amateurs had known of his exploits and accomplishments; many amateurs have advanced to world prominence. The field is wide open, for, where there are a million people complaining of interference, there is a market for a million receivers that will prevent that interference; and every broadcast listener is a potential operator and some early morning you will pick a new note whistling through the ether and find that Mr. Broadcast Listener is calling you on his new C.W. transmitter.

### SOME JOB

Secretary Hoover says he doesn't care who controls radio, and is willing to turn it over to the Interstate Commerce Commission if Congress so decides, but he does insist that some regulations be enacted into law and that someone be put in charge to relieve the interference, handle licenses, and assign the waves.

## THE FRANSDEN TUNER AND VARIOCOUPLER

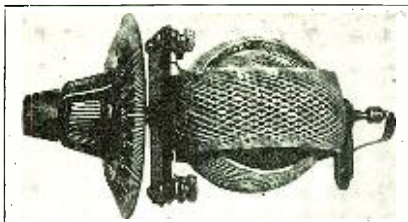

**AT LAST THE PERFECT TUNER for Broadcast Reception.**

The most efficient and selective tuner made. For single circuit with tickler or variocoupler with loose coupled primary and secondary circuits.

Perfect and continuous variation of the inductance of the antenna circuit without SWITCHTAPS and without a VARIABLE CONDENSER in the antenna circuit. Complete for panel mounting, postpaid, \$7.50.

**RADIO RESEARCH LABORATORIES**  
ATASCADERO, CALIFORNIA

**"COPPERWELD"**  
THE IDEAL RADIO ANTENNA

COPPERWELD IS 50% STRONGER than Copper, can be strung taut, stays up when other wires stretch and break, and gives 100% electrical efficiency.

COPPER GLAD STEEL COMPANY  
BRADDOCK P. O. HANKIN, PA.  
Directions for Antenna construction on reverse side of carton





### *The thrill of great distance*

For 12 years, Tuska-built radio receivers have been famous for long range reception, and have made records that are unsurpassed.

F. R. Alger, of Prince Albert, Saskatchewan, Canada, says, "I am sending a list of 67 stations, a total distance of 78,200 miles away. You will realize that all stations are far removed from us; most of them have to come over 1000 miles. The Tuska is remarkable for simplicity of tuning. It has been a source of great satisfaction."

#### Tuska Popular No. 225

3-bulb Regenerative Receiving Set. Piano finish mahogany cabinet. Amplifier switch. Concealed binding posts. Armstrong circuit, licensed under Patent No. 1,113,149. Price \$75, without bulbs, batteries or loud speaker.

Ask for special circular No. 11-E, describing this set.

*You needn't know  
a thing about radio*

NIGHT after night, year after year, a Tuska Radio will bring fine entertainment into your home, at a trifling expense for operating.

You need not depend upon good-natured friends with radio experience to help put a Tuska in your home. Surprise them all by doing it yourself. It is easy to install your own "listening post" and pick up your choice of the concerts that fill the air.

At pleasure you can tune out any program and tune in another

more to your liking. The same Tuska that fills your rooms with clear, unmarred music and distinct speeches will also pick up broadcasting from stations 2000 or more miles away.

Some of the most experienced radio inventors and engineers in this country designed and built the Tuska. It is right, forever, and needs no tinkering. Have no fear that it will soon become obsolete. A Tuska set bought to-day will be serviceable for years to come.

THE C. D. TUSKA CO., Hartford, Conn.



# TUSKA RADIO



## REGENERATIVE RECEIVER No. 102



THREE TUBE RECEIVER, NO. 102  
(Licensed under Armstrong U. S. Patent No. 1,113,119)

Chelsea Regenerative Receiver No. 102 is a supersensitive instrument operating on wave lengths of from 100 to over 600 meters. It combines great range and selectivity.

A Regenerative Circuit with two stages of audio frequency amplification is used. Most efficient adjustments are made possible by the use of vernier controls incorporated in the variocoupler and tuning condenser. All binding posts are enclosed in the cabinet eliminating all visible wiring. All insulating material is genuine bakelite, moulded in the Chelsea factory. The cabinet is solid mahogany, beautifully finished with space for batteries. Price \$95.00. Write for Booklet A.

## CHELSEA PARTS

The National Chelsea Radio Corporation offers a complete line of parts. These are identical with those responsible for the marvelous results obtained by Chelsea Receivers. For complete description and prices write for Booklet "B."

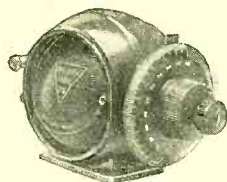

Variometer

The Chelsea Vernier Variometer is the last word in variometer design. It covers an extreme range from (100 to 600 meters) with the closest tuning. Genuine bakelite especially moulded by Chelsea is used throughout. It has no sliding contacts. Furnished complete with dial and vernier.

Variometer No. 80, \$8.00

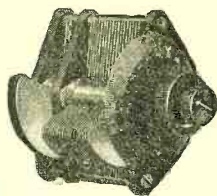

Variable Condensers

The Chelsea Variable Condensers contain only genuine bakelite insulating material. Rotors and Stators are die cast into solid units with perfect alignment of the plates. Spiral connections to rotors. Furnished with from 3 to 45 plates. With or without vernier. Capacities from .00025 to .001 M. F.

Prices from \$2.50 to \$6.75

Write to Dept. 7 for Booklets—"A" for complete receiving sets and "B" for Parts.



## The Great Radio Message from Mars

(Continued from page 540.)

Thank ye, sir!"

"And for that reason, Mr. Casey, sir," I said, when I handed him the cigar, "it is held by some that Professor Duff in fact heard a message from the moon Daimos, and not from Mars itself. Now, let us consider the facts! Professor Duff had gone far in radio experimentation—"

"He went too far when he took the axe and exterminated his wife and his parents and his mother-in-law," said Mr. Casey. "I'm no radio nut, but I say he went too far!"

"An incident; a mere incident," I said. "No doubt they annoyed him. Perhaps he was working on his set and they called him to dinner. That always annoys a radio enthusiast. In such cases the radio enthusiast sometimes kills, and sometimes he merely wishes to kill. But what Professor Duff did to his family is a mere incident."

"It was an incident for them, all right!" said Mr. Casey. "It was worse than an incident; it was an accident."

"Yes," I said, "no doubt—"

"Ye ought t' laugh," Mr. Casey said. "That was a joke I was makin'. I says t' you 'It was worse than an incident; it was an accident.' He dented them with th' axe, d' ye see? An axe-i-dent. You should laugh."

"Oh, yes; ha-ha!" I said hastily. "But to get back to the important matter. Professor Duff would sit for hours working with his radio set, either listening in or changing its make-up. Often he would sit for ninety-two hours at a time, laboring with true scientific eagerness, for he held the theory that if he could make the proper adjustments he could hear from the spirit world. He particularly wanted to hear from his uncle Silurius Duff, who departed this life when he happened to try to drive a ten-ton truck through a freight car loaded with dynamite. Professor Duff came of a highly religious and temperate family, and it was his boast that no one in the family had ever tasted liquor, but the coroner's jury brought in the verdict on his uncle Silurius 'Killed by a car of dynamite while trying to drive a ten-ton truck through it while intoxicated.' Naturally Professor Duff wished to talk to his departed uncle and ask him whether he had indeed taken to drink or merely had something go wrong with his steering gear."

"A man can't trust none of them bootleggers these days," said Mr. Casey sadly. "They say it is good stuff and when you taste it, it ain't nothing but carbolic acid or prune juice."

"Exactly!" I said. "And so, Mr. Casey, sir, Professor Duff tried every experiment possible in order to hear from his uncle Silurius, and he finally decided that success rested in finding a proper substitute for the ordinary crystal. He tried every variety of crystal. He tried salt crystals and ammonia crystals and sugar crystals. He tried every known crystal but, unfortunately, every failure made him more and more morose. He yelped bitterly when his wife brought him food. He swore and raged when his mother-in-law breathed, for she had asthma and he often thought the noise she made was static. He even became angry with his dear old mother when she said she thought the crystal he was trying to invent was a little strong."

"For you know, Mr. Casey, sir," I continued, "Professor Duff attempted to create a new crystal to be known as the 'Uncle Silurius Duff Crystal.' No doubt he was on the right road. He was seeking a crystal (Continued on page 601.)"

SEND FOR YOUR FREE COPY

## TESTED HOOK-UPS

SUBMITTED BY USERS OF OUR



WONDERFUL TRANSMITTER

BUTTON FOR LOUD SPEAKERS

Price \$1.00  
POSTPAID  
with instructions

AMPLIFICATION AND EXPERIMENTS

K. ELECTRIC CO.

15 PARK ROW

NEW YORK

## United Y. M. C. A. Radio Schools

The largest radio school chain in the Country.

Interesting Work Good Pay

If you are red blooded and like adventure, study radio. Complete laboratories fitted with the very latest apparatus. All instructors experienced radio men. Dormitories, Restaurants and Swimming Pool for use of students. Complete radio training in the shortest possible time. Send today to the nearest school for full information.

New York City  
158 East 86th Street  
Seattle, Wash.

Central Branch Y. M. C. A.  
Los Angeles, Cal.  
Los Angeles, Y. M. C. A.



# A Triumph in Radio

## The Single Tube Radio Frequency Receiver

### Performs the Function of 2-Tubes

Only One Control  
All Wave Lengths

Entirely new circuit. One tube performs the double function of radio frequency amplifier and detector.

Simplicity and Economy. One simple tuning control gives selectivity equal to sets costing hundreds of dollars.



**\$10<sup>00</sup>** Without Tube

Including Two Interchangeable Inductance Coils for Wave Lengths ranging from 200 to 600 Meters

#### "A WONDER"

Dear Sirs:  
When your Monodyne sample arrived, to be entirely frank, we did not believe it capable of doing very much on long distance work. After carefully testing the set, we feel that we owe you an apology.  
The National Monodyne naturally percolated all over the place; we heard Davenport, Chicago, Dallas, Texas, and Atlanta, Ga. The next night we took it to the home of Mr. Metzger, President of the Western Radio Company here, and we heard another string of stations, using the WD-12 tube with two 22½ "B" batteries.  
Your Monodyne is certainly a wonder.  
We are enclosing our initial order, which kindly rush at the earliest moment.  
The Radio-Electric Shop, Inc.  
225 East Tenth Street,  
Kansas City, Mo.

# NATIONAL MONODYNE

PAT. TRADE MARK PDG.

## TUBE SET

### MODEL GT-1

#### 1000 MILES ON THE MONODYNE

Gentlemen: Having purchased your Monodyne set I was more than pleased over the results obtained from it. I think it is one of the best one-tube sets on the market today.  
I have heard the following long distance stations—WD&F Kansas City, WDAP Chicago, WSB Atlanta, WOO Philadelphia, WGY Schenectady, WOC Davenport, and a Canadian station whose call letter I could not obtain.  
Using hook-up No. 4 gives very selective tuning and volume. Your set cannot be praised too highly.  
WILLIAM BROWN  
65 East 117th St., N. Y. C.

The **MONODYNE** CIRCUIT is one of the most radical advances in radio engineering since the advent of the Armstrong Circuit. Parts heretofore considered essential are omitted and one simple tuning control gives a selectivity equal, if not superior, to that of sets costing hundreds of dollars. A child can operate it.

#### SIMPLICITY

The **NATIONAL MONODYNE** uses but one dry cell tube, preferably the WD-12 or any other standard dry cell tube, such as the UV-199 or C-299 types. Local broadcasting comes in astonishingly loud and clear, without distortion.  
The tube socket is of a new design and most practical because it holds the tube with a positive grip on all four prongs for a depth of more than one-quarter of an inch.  
The **NATIONAL MONODYNE AIRPHONE** will find especial favor with experimenters because of its adaptability in many different hook-ups, a thing not possible with any other low priced outfit.

#### LONG DISTANCE

In our New York laboratory tests, we repeatedly heard stations KYW at Chicago, WOC at Davenport, Iowa, and many others, quite loud and clear. This without resorting to any mode of amplification.  
The **NATIONAL MONODYNE** is the most practical tube set made, and is complete in all details. It is only 6½ inches long, 4¾ inches wide, and 2¾ inches high of durable, compact and rugged construction. The entire casing is moulded from hard rubber composition.  
The **NATIONAL MONODYNE** has a receiving capacity and range of about 1500 miles. 75-foot aerial is recommended for best results.

**No more Hunting for stations. You know in advance at what point of the scale your favorite station is located—only the highest priced sets accomplish this.**

Dealers, Jobbers and Distributors—Send for Samples and Prices

#### SEND NO MONEY

National Airphone Corporation, R. N. 11  
18 Hudson Street, New York City, N. Y.  
Gentlemen:  
Please send me prepaid One (1) **NATIONAL MONODYNE** tube set, Model GT-1, for which I will pay the postman \$10.00.  
NAME .....  
STREET AND NO. ....  
CITY ..... STATE .....

**NATIONAL AIRPHONE CORPORATION**  
18 HUDSON ST. NEW YORK

# NATIONAL Interference Eliminator

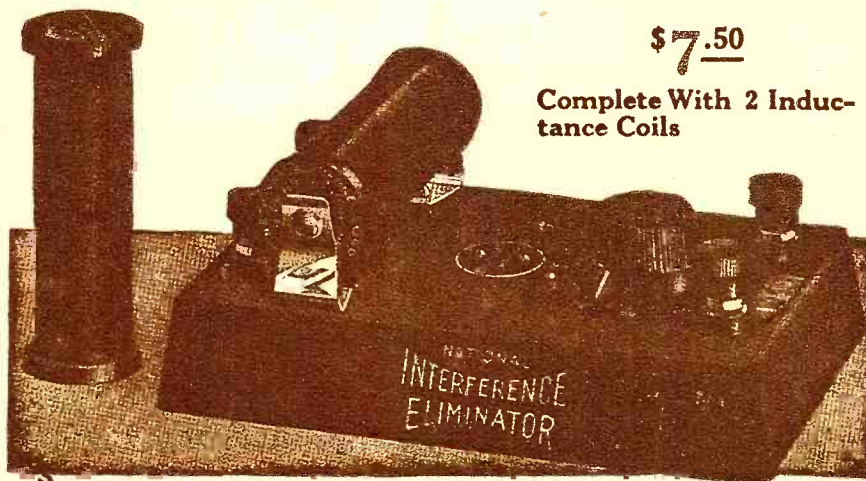

**\$7.50**

Complete With 2 Induc-  
tance Coils

Adds selectiv-  
ity to your  
set.

Tunes out side  
waves or har-  
monics of pow-  
erful broadcast-  
ing stations.

Will make  
your set tune  
sharper.

Two coils go with  
instrument, one  
for short and  
another for long  
wave lengths.

The National Interference Eliminator can be used with all radio outfits no matter what make, tube or crystal. Will bring in stations you never heard before. Nothing else required with set as illustrated. Just connect it with two short wires to your outfit.

**A NATIONAL STANDARD INSTRUMENT OF MERIT AND RELIABILITY**

Eliminates Broadcasting and Code-Signal Interference

Can be used to increase or shorten Wave Lengths

**AN ABSOLUTE NECESSITY TO CLEAR RECEPTION**

## NATIONAL AIRPHONE "GOLD-GRAIN" DETECTORS

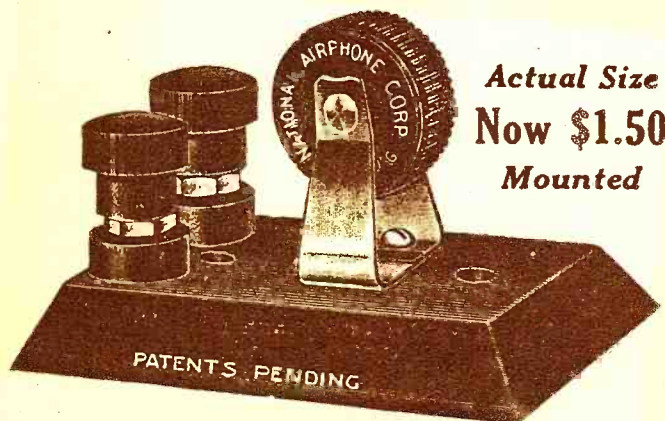

Actual Size  
Now **\$1.50**  
Mounted

After you have fussed with catwhiskers, springs, balls and adjustment handles, and after you have almost become a nervous wreck, hunting for "the elusive sensitive spot"—you will welcome with open arms our 100 per cent. **GOLD-GRAIN DETECTOR.**

This Detector is foolproof; has no catwhiskers; no springs, no balls, no adjusting handles; no fussing. The detector is entirely enclosed in hard rubber composition cartridge, but it is **NOT** a fixed detector.

A special crystal is used, while contact elements are made of pure gold. There is always a multiplicity of contacts. The Detector is sealed hermetically. The contact with the crystal is always perfect.

This detector has been pronounced by experts as the greatest detector in existence. It reproduces voice, and music in natural color of tone, without distortion. You will be surprised at the wonderful results and satisfaction obtained with the "GOLD-GRAIN" Detector.

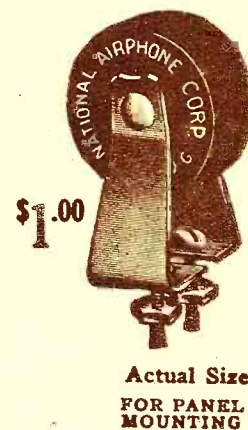

**Most Practical for Reflex and Crystal Sets**

Dealers, Jobbers and Distributors—Send for Samples and Prices

# NATIONAL AIRPHONE CORPORATION

20 HUDSON ST.

NEW YORK

**SEND NO MONEY**

National Airphone Corporation  
20 Hudson Street, New York City, N. Y.

R. N. 11

Gentlemen:

Please send me prepaid the articles crossed, for which I will pay postman upon delivery the advertised price.

One  National Monodyne  
One  Interference Eliminator  
One  Panel Detector

NAME .....

STREET .....

CITY ..... STATE .....

# This ONE-TUBE Set Runs A Loud Talker

Build It With Consrad Pattern No. 8



## How to Make an Autoplex Receiver

The "Autoplex Receiver" is the long expected one-tube set that will work a loud speaker. This circuit was invented by M. L. Muhleman of the Radio News Staff and is bound to become popular because it will operate wherever placed and requires but a ground connection. Every station within its range is amplified sufficiently for a loud speaker. Tuning is very simple, there being but two controls. It is inexpensive as to parts and easy to construct. Any tubes from the "peanuts" up to the "big ones" can be used. This receiver knows no such thing as "critical filament adjustment." It will receive the high powered trans-Atlantic stations without any changes in the circuit; a twist of the dials and the broadcast stations come in.

The complete plans for the construction of this set are contained in a three-colored, heavy manila packet, 9x12 inches and consist of full sized blue print for wiring and drilling and also a four-page instruction pamphlet giving complete details even as to tuning. Price complete..... **50c.**

## Other Popular Patterns of the Consrad Line

### How to Make a Neutrodyne Receiver—50c.

This pattern gives the complete assembly, wiring, adjusting and tuning of a five-tube Neutrodyne receiver. This type of receiving outfit was brought out after extensive experimenting and is noted for its very efficient radio frequency amplification. All the disadvantages of ordinary radio receivers, such as distortion and re-radiation are eliminated. The circuit is also noted for keeping the tubes from oscillating. Put up in heavy manila packet, 9x12, cover in three colors, full size blue prints for drilling and wiring and four-page instruction pamphlet.



### How to Make a Reinartz Receiver

The original Reinartz Receiver is the most popular type of set in existence today. It gained its popularity through its simplicity of operation and capability of long-distance reception. Full directions for building this receiver are given in this folder. The construction of the coil—the most difficult part—is made easy with the concise instructions we furnish. The connections of the set are shown plainly, so that the novice will have no trouble in following them.

**50c.**

### 14 Radio Formulae and Diagrams

With this packet of radio knowledge you need never worry about schematic wiring diagrams, measurements and radio tables. All formulae and diagrams are printed on heavy paper in black and blue; and contained in two-color printed envelope, 9x12 inches.

**50c.**

### How to Make a Cockaday Receiver

The Cockaday four-circuit tuner is one of the latest advancements in radio. Its main advantage lies in the fact that the set can be adjusted to the highest point of regeneration, and tuning accomplished over a wide band of wave-lengths without the necessity for readjusting the regeneration control. The set described in our folder was designed and built at our own shop. All dimensions, size of wire, number of turns, etc., are given, leaving nothing to the imagination.

**50c.**

### All About Aerials and their Construction

These blue prints were made after practical erection of each aerial, and point out how simple it is to erect not only the proper aerial for your particular need, but how to erect this aerial in the most practical manner and at the least expense. Consists of 12 blue prints 8½x11 inches and one four-page instruction pamphlet 8½x11 inches.

**50c.**

### How to Make a Reflex Receiver

The plans for the reflex receiver were gotten out only after considerable research work by our engineers. Most people have trouble with reflex receivers. It takes an expert to build one that will work satisfactorily. The trouble lies in the values of condensers, etc., in the circuits. If they are incorrect, the set is a dismal failure. The constructional details of a reflex receiver, contained in this folder, are the results of their successful efforts.

**50c.**

### 20 Radiophone Diagrams and Hook-Ups

These diagrams show how to get the best possible efficiency from the instruments you make or purchase. They cover hook-ups from the simplest to the most complicated, in a way that any amateur can understand and follow without difficulty. Printed on heavy paper, 8½x11½ inches, and together with KEY CHART OF SYMBOLS and pamphlet "How to Read Diagrams", are contained in a heavy two-color envelope.

**50c.**

For other patterns we publish see page 658 of this issue

If your dealer cannot supply you, order from us, giving his name and address

**The Consrad Co.**  
INC.  
Formerly The Consolidated Radio Call Book Co.

**233 Fulton Street, New York City**  
Publishers of Consolidated Patterns and Sales Agents  
for E. I. Co. Books

(Continued from page 596)

that would bring his uncle Silurius through clearly from the spirit world, and for that reason he sought a material that would be so to speak, in rapport with his uncle Silurius Duff. He remembered that his uncle Silurius, while on earth, was fonder of limburger cheese than of anything else. So Professor Duff, with keen scientific acumen, attempted to make a limburger cheese crystal. First he boiled the limburger cheese in garlic—

"If I was his folks," said Mr. Casey, "I would have took the axe to him before he had a chance to use it on me. The time t' use an axe is when a man starts in to boil th' limburger cheese, let alone the garlic. Not that, in the old days, a thin slice of limburger cheese, lib'rally smeared with mustard, bechoon two cuts of moisty rye bread, didn't go good with a glass of beer. Limburger cheese has its uses. Yes, sir! But boilin' it to make crystals of ain't one of them. No, sir!"

"You are right, Mr. Casey, sir," I said. "And although Professor Duff has never acknowledged it in writing, I am sure you are right. He had no success whateve in crystalizing the limburger cheese after it had been boiled. It would not form itself into crystals. It formed ropes and slabs of limburger linoleum and soup, but it would not form crystals. It formed odors so strong that the roof flopped up and down and the foundations of the house palpitated, but it would not crystalize. And it was then, when all seemed darkest, that Professor Duff heard of the meteorite that had fallen near Pesquaguntic, Maine. He immediately decided to try a crystal from that meteorite. With a flash of inspiration he knew that it would be different from an ordinary crystal."

"Like different Haig & Haig you get from different bootleggers these days, as I'm told," said Mr. Casey. "One is like unto cold tea and the next is nothin' but jagged lightning with the edges filed sharp. The one has no effect that wouldn't permit you to sit amongst nice ladies and knit a pink wool sweater, but a jolt of the other makes a man want to climb a tree and bite a grizzly bear on the neck."

"Truly!" I agreed. "And Mr. Casey, sir, it was while Mr. Duff was awaiting the crystal from the meteorite that fell at Pesquaguntic, Maine, that he decided the meteorite must have come from Mars. His mental process in arriving at this conclusion was sound. 'Mars' he said to himself, 'has long been wanting to get into communication with the Earth, but until the invention of radio this has been impossible. Now it is possible. But,' he argued, 'the Martians have doubted that Earth has a proper crystal to use in receiving Martian communications. Therefore, the first thing the Martians would attempt would be to send the earth some of the Martian crystals. Mars, wishing to do this, would undoubtedly rig up a large cannon, load a lot of crystal into it, and fire it at the Earth. That is what this meteorite undoubtedly is. So, when I have the crystal taken from the meteorite, I shall be able to communicate with Mars.'"

"But, hold on now!" said Mr. Casey. "I'm not knowin' much about these radio sets, mind you, but wasn't someone after telling me that them crystal sets don't get messages from very far off?"

"Mr. Casey, sir, you are right," I said, "but you must remember that Mars is only 48,600,000 miles from the Earth."

"Sure!" Mr. Casey agreed. "I was almost forgettin' that."

"Which is not far for a crystal set," I said, "if constructed by a man who knows how to build a set properly."

"Of course not," said Mr. Casey. "What's forty-eight million miles more or less anyhow? Does your crystal set listen in that far, sir?"

# No Matter What Your Vocation

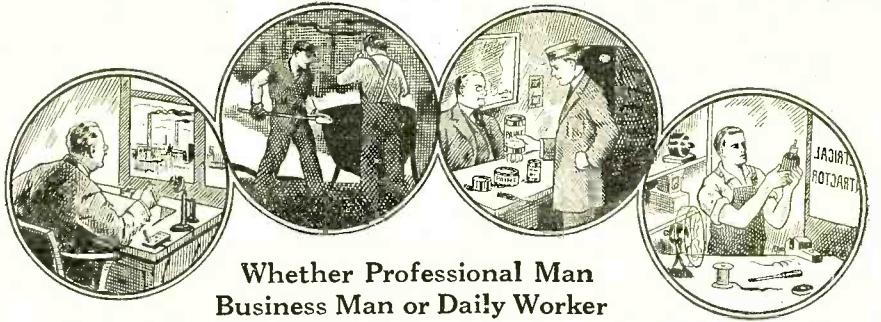

Whether Professional Man  
Business Man or Daily Worker

## A Thorough Training In CHEMISTRY Will Help You To Get Ahead

**T**O be successful today is to know Chemistry! Every line of business, every branch of industry depends upon Chemistry in some form. You may not realize it, but your own proficiency in whatever work you are doing would be increased by a knowledge of Chemistry. In many lines such knowledge is absolutely essential. In others it is a guarantee of promotion and more money.

The keen competition that exists in every commercial activity today requires that a man know all there is to know about his vocation. If you have something to sell—no matter what—Chemistry enters into its make-up. The salesman who knows the chemical composition of his article can talk about it more intelligently than the one who lacks this information, and his sales are proportionately larger. In the building trades Chemistry is of prime importance. The mason, electrician or painter who knows something about Chemistry can do better work and command more money than the one who does not. Through Chemistry a shop-keeper learns how to attract the most trade, and even in clerical positions one can capitalize his chemical skill.

Chemistry should be as much a part of your mental equipment as the ability to calculate or to write correct English. The world is paying a thousandfold more for ideas than for actual labor. The big rewards go to the man who can show how to turn out a little better product at a little lower cost. And Chemistry will give you the ideas that will save money for yourself or your firm in the very fundamentals of your business. There is nothing remarkable about this; it is going on every day. If you have not heard of it before, it is because the general public has been slow to recognize the tremendous value of chemical training. People have been content to leave Chemistry in the hands of a few trained chemists who could not possibly develop the subject to anywhere near its greatest extent.

Now we are on the eve of a great awakening. Our heritage from the World War has been an intense development of the chemical industries in the United States and a tremendous interest in all the applications of Chemistry. People are taking up the subject merely for the good it will do them in their own line of business.

It is no longer necessary to enter college in order to learn this fascinating science. Our Home Study Course trains you just as thoroughly, and with the same assurance of success, as those who took the longer way. And our methods are so simple that we can teach you no matter how little previous education you may have had. Many of our graduates now hold responsible positions or have materially increased their incomes from private enterprises as a result of taking our course. Hundreds of letters from students testifying to the benefits they have derived from our training are here for your inspection.

Remember that you do not need to study Chemistry with the idea of actually practicing as a chemist, although a great many of our students are taking our course with this object in view. If you want to know more about what Chemistry will do for you, if you want to know what our home study course offers, sign and mail the coupon today for FREE BOOK "Opportunities for Chemists."

### Chemical Institute of New York, Inc.

Home Extension Division 11

66-R West Broadway, New York City

### DR. T. O'CONOR SLOANE Will Teach You Chemistry In Your Own Home

The Chemical Institute of New York, of which Dr. T. O'Conor Sloane is Educational Director, was founded to fill the need of ambitious, far-sighted men who realize and recognize the splendid future Chemistry offers them, but who cannot spare either the time or the money to attend college. Dr. Sloane, a foremost authority on Chemistry, will teach you and will give you individual help you may require. He will personally go over your papers, correct them, point out your faults, teaching you in a practical and interesting way. No special education required other than the ability to read and write English. One student has characterized our lessons as "The course that takes the mystery out of Chemistry."

### Read What One of Our Recent Graduates Reports

"I thought I would let you know of my success. I finished your course about two months ago and now have a fine position as chemist at the DuPont Dye Works. I am getting along fine with my work and like it very much. It was through your course alone that I have been so successful. It is wonderful and I hope you have great success with it."

(Name and Address on request).

### Easy Monthly Payments

You do not have to have even the small price of the course to start. You can pay for it in small monthly payments—so small that you won't feel them. The cost is very moderate, and includes everything, even the Laboratory Equipment—there are no extras to buy with our course. Our plan of monthly payments places a chemical education within the reach of everyone.

### Laboratory Equipment Given To Every Student Without Additional Charge

We give to every student without additional charge his chemical equipment, including forty-two pieces of laboratory apparatus and supplies, and seventeen different chemicals and reagents. These comprise the apparatus and chemicals used for the experimental work of the course.

### Special 30-Day Offer

For a short period we are making a special offer that will be worth your while to take advantage of. Write for particulars, using the coupon below or simply a postal card. This will not obligate you in the least. Do not wait until to-morrow. Send the coupon now while you think of it.

### Sign and Mail the Coupon for FREE BOOK

CHEMICAL INSTITUTE OF NEW YORK, Inc.  
Home Extension Division 11,  
66-R—West Broadway, New York City.

Please send me at once without any obligation on my part, your Free Book "Opportunities for Chemists," and full particulars about the Laboratory Equipment furnished to every student. Also please tell me about your plan of payment and your special 30 day offer.

NAME .....

ADDRESS .....

CITY .....

STATE .....

RN. 11-23

# WALNART

**PERFORMS**  
**100%**

## Radio Confidence and Walnart Products

The feeling of security, the knowledge that the part is working right, gives the radio fan a new delight—for no matter what may occur, he has learned that "Walnart" perform 100%.

You too can have this feeling of security if you equip your set with Walnart Parts. They cost no more than the other kind—and pay you over and over again in their continued 100% performance.



**Vernier Adjuster**



**Variable Condensers  
(Plain and Vernier)**



**Tube Socket**



**Variable Grid Resistance**

Send for catalog of  
*Walnart Trouble  
Proof Radio Parts.*

Variable Condensers  
(Plain and Vernier)  
Variable  
Grid Resistance  
Inductance Switch  
Tube Sockets  
(Standard and  
UV199)  
Vernier Adjusters



**Inductance Switch**

**WALNART ELECTRIC MFG. CO.** Dept. 603  
1249 W. Van Buren St.  
Chicago, Ill.

"Mr. Casey, sir," I said solemnly, "I give you my word that on June 17, 1923, I was listening in on my crystal set—one I made with my own hands, using only a cigar box and three dollars worth of material—when I distinctly heard a sound that I can best describe by saying 'Piff! piff!' For a few minutes I thought it was merely static, but a little consideration told me that no static had ever said 'Piff! piff!' in that tone of voice. Immediately I knew I was hearing a sun spot piff-piffing. And, Mr. Casey, the sun is 92,900,000 miles from the Earth. I need say no more regarding the capabilities of a well constructed crystal set."

"And, to talk plain t' ye," said Mr. Casey, "you'd better not."

"So, Mr. Casey, sir," I said, "I only need remind you of what you already know: Mr. Duff secured a crystal from the Pesquaguntic meteorite, put it in his set, and immediately heard from Mars."

"And went and dented his whole family with the axe," said Mr. Casey.

"Ah!" I said. "But that was necessary. He explained all that to the coroner. The members of his family were so full of negative animal magnetism that it spilled out of their ears, flowing through the house and short-circuiting the Martian ether waves. Professor Duff quite plainly informed the coroner that he had not meant to kill his family—that they died was entirely an accident. He merely wished to knock small holes in the tops of their heads, so that the negative animal magnetism—instead of flowing downward from their ears—would spout directly upward from the new holes in their heads and pass harmlessly into the upper atmosphere. You will recall, I am sure, Mr. Casey, sir, that after he had made the holes in the tops of their heads by tapping them there with the axe, he took them into the front yard and seated them back to back. He did that because his aerial was in the back yard. He did not want the negative animal magnetism to spout up against his aerial. It was, I admit, unfortunate that his family could not stand a simple jolt on the head. That was their fault, not his. The family of a true radio enthusiast should be so built as to stand more than that when the radio enthusiast is enthusing normally."

"Is that so! Is that so, now!" said Mr. Casey in a tone I did not quite like. "And I suppose you would tap your own wife on the head with an axe if you got a notion she was a nuisance to your radio fooling?"

"No," I said promptly. "No, Mr. Casey, sir! I would not. I have given the matter deep consideration and if I ever wish to communicate with Mars—as I expect to shortly—and my family oozes negative animal magnetism from their ears, I shall not puncture their heads with an axe. I have a far better plan. I shall bore holes in the tops of their heads with an augur."

"I see! I see!" said Mr. Casey in a tone I thought distinctly foxy. "So that's the general idea, is it? And what was it you said you'd be wanting to ask this Duff guy, now?"

"A very simple question, Mr. Casey, sir," I said. "Up to the present time Professor Duff has not told the world what message he received from Mars. I want to hear from his own lips what that message was. I want to ask him to confide to me, in absolute secrecy if need be, the message he heard on that wonderful day. If possible, I want him to allow me to repeat the message to the members of the Upper Flushing Scientific and Annual Clambake Association, so that we may make the investigations we desire to make to learn positively whether the message was from Mars itself or from the moon Daimos. Or, possibly, from the moon Phobos."

"And how will you know that?" asked Mr. Casey.

## ONE THOUSAND AGENTS WANTED

WE want one thousand agents to sell subscriptions to RADIO NEWS, SCIENCE AND INVENTION and PRACTICAL ELECTRICS. We will pay a generous commission for this work and help you in every way. Our three publications are leaders in their fields, ready sellers and this is an offer well worth your while. A few spare hours a day will bring you a handsome return. Write regarding our proposition at once and be the first one to get started in your vicinity.

**Experimenter Publishing Co.**  
HERBERT H. FOSTER, Sales Manager

53 Park Place New York





# A Wonderful Radio Bargain

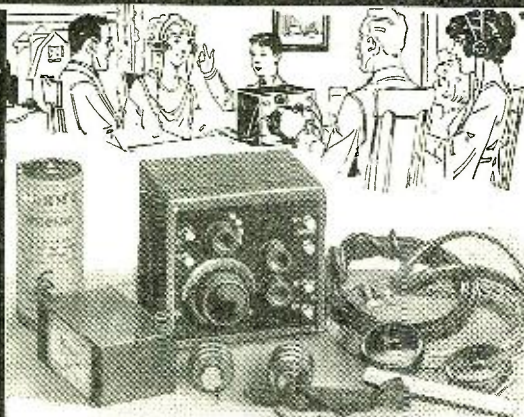

**Receiving  
Radius  
600 Miles**

**\$23<sup>25</sup>**

## Armstrong Regenerative Set

Licensed under the Armstrong Patent No. 1113148 for amateur experimental and scientific use only.

**H**ERE is a money saving Radio Outfit that will bring the news of the world—concerts, lectures and stock reports—into your home. Would ordinarily cost \$35.00 to \$40.00. Sold complete with head set, tube, batteries, aerial and ground wires, for **only \$23.25!** Connections simple and plainly marked. Easy to tune. Long receiving radius. Order NOW! Shipping weight, 12 pounds.

57RN9366 ..... \$23.25

SEND FOR

### Our New Radio Catalog

Everything for radio at lowest prices, including other complete sets. Many new hookups, complete list of broadcasting stations. Contains "How to Build an Aerial." Invaluable to expert and amateur. Mailed free. Ask for Radio Catalog No. 82R05.

**Send for this  
FREE Catalog**  
**Sears, Roebuck  
and Co. Chicago - Philadelphia**  
THE LARGEST MAIL ORDER HOUSE IN THE WORLD



## A "B" BATTERY Built for Radio By Radio Experts

The Improved Re-chargeable "B" Battery  
Insures Noiseless Radio Circuits

With the SIDBENEL Re-chargeable "B" Battery you can count on four or six months' service on one charge alone. Recharging costs you only a few cents and with ordinary care the battery will last 5 YEARS in normal service. That is one of the many reasons why

### Sidbenel Storage "B" Batteries

are universally recognized as "Perfect for Radio Work."

Its many SPECIAL NEW FEATURES include:

Hard Rubber Container  
Separate sealed cover for each cell

Extra large plates  
Brings signals in very loud.

### SPECIAL PATENTED PLATES ARE USED

They will give an immediate discharge of FIFTEEN AMPERE and a voltage of twenty-two and one-half variable from two volts up. Should it become partly discharged at any time, just connect it to your charger, lamp-socket or lighting generator, and within a few hours your SIDBENEL STORAGE "B" BATTERY will be recharged to its full capacity, costing you less than one-half a cent, and saving you the price of a new battery. Each time the battery becomes discharged you simply recharge it.

Variable Type 201D Assembled	Knocked Down	
1 unit 22½ volts.....	\$ 5.00	\$ 4.00
2 units 45 volts.....	9.80	7.75
4 units 90 volts.....	18.00	14.75
5 units 115 volts.....	22.50	17.75
A. C. Rectifier.....	1.50	.85

Complete illustrated directions for charging from your lamp socket or from your generator and how to assemble come with each battery.

Send for complete catalog of parts

Trade in your old Sidbenel with \$2.00 for new type.

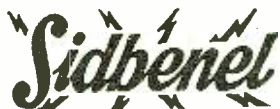

**RADIO EQUIPMENT MANUFACTURING COMPANY**  
25 Mt. EDEN AVE., NEW YORK CITY

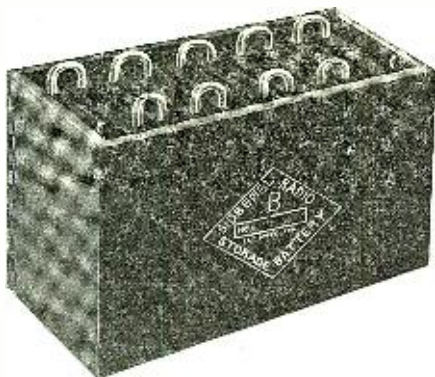

"By the words of the message, undoubtedly, Mr. Casey, sir," I said. "By the manner in which Professor Duff has so closely guarded the message, giving it out to no one, not even to the Sunday newspapers, I am convinced it was a message of the utmost importance. No doubt it is a message that, when revealed, will change the whole future history of the world. It may, and doubtless will, change our forms of government, give us a new religion, give us an insight into the spirit world, and make of all men real super-men. By the phrasing of that message he received we may be able to judge whether it came from Mars or from the moon Phobos. It may be slightly different in dialect—"

"Well, go on, then, and ask him," said Mr. Casey. "He's in the nice little room down yonder, with 675 above the door. But don't be long. And don't rile him."

I walked down a corridor which had rooms on either side, all neatly barred to prevent persons from annoying those inside, and I found Professor Duff. He came to the door and grinned at me through the bars, and I told him frankly what I wished. I explained the greatness of the Upper Flushing Scientific and Annual Clambake Association.

"Professor Duff, sir," I said, "as a delegate from that Association I am empowered to beg you to confide to us the message you received by radio from Mars. If possible we want your permission to give it to a waiting world. Until now you have kept it secret. It is time you let the millions of eager inhabitants share the message with you. In the name of Science, and for the good of the world, will you tell me what the message was?"

For a full minute Professor Duff looked me in the eye. Then he said:

"Yes, I can trust you. You will repeat the message ungarbled and untwisted. I will tell you what it was."

I trembled in every limb. I was frightfully excited, but I tried to be calm.

"What, sir," I asked, "was that world-epoch message you received from Mars?"

"It was," said Professor Duff, "this: 'Yes, we have no bananas.'"

And then he climbed hastily up the bars of his door and uttered low twittering sounds, like a squirrel.

## The Amateur To the Rescue of the BCL

(Continued from page 531.)

quency amplifiers sufficient to give any reasonable distance and volume. A fine high frequency synchronous spark transmitter was also among their possessions.

The instruction that they gave could not be beat outside of a regular school. Theory from the most elementary to the most advanced was expounded by several competent instructors, and helped along by the members themselves. There were code instruction tables that could be worked at all speeds, and beginners were soon graduated into the experienced class.

A separate room was fitted up as a workshop, in which tools and materials were supplied for building and repairing all sorts of apparatus. A very nominal charge above the regular dues was made to those members who wished to use the shop, in this way making it self supporting. A very complete library of radio and electrical books completed the list of the club's belongings.

About a year ago the members thought they would like to extend their sphere of usefulness, and include the broadcast lis-

# Send For This Handy Book Today

*Contains  
Description and  
Illustrations of all  
Radio Parts*



*Explains  
Functioning of the  
Apparatus in the  
Different Circuits*

## *This Pocket Size Edition Gives:*

Variable Condenser Capacities—Variometer construction—Illustrations and description of radio symbols. Q Why rheostats should have greater contact surface. Q Advantages of light weight receivers. Q Why Bakelite is the best insulation for radio. Q New and ingenious inductance switch and knob—Defines radio terms—Explains importance of good aerial and ground. Q But—most of all—It shows the beginner, why the highest class apparatus is the most economical and satisfactory—54 pages of interesting information and illustrations.

HIS BOOK IS FREE



**Write for it today. Address Radio Dept. A.**

**KELLOGG SWITCHBOARD & SUPPLY COMPANY**

1066 W. Adams St. · Chicago, Illinois

Columbus, Ohio

Kansas City, Mo.

Portland, Ore.

San Francisco, Cal.

# It's the Contact that counts



Adapter No. 429 for 199 Tubes, 75c



De Luxe No. 400 Price 75c



Small-space, No. 401 35c. 3 for \$1.00

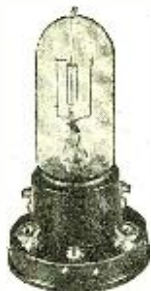

Na-ald W.D.11 No. 411 Price 75c

A CAREFUL examination will show that each contact in Na-ald sockets and adapters is of a wiping nature on a broad surface, and so designed that strong tension is permanent, no matter how often the bulbs may be removed or how much the connecting prongs in the tubes vary.

Na-ald sockets are moulded of Bakelite, with uniform cross-section and cure, and other engineering features incorporated to avoid plate to grid losses and to insure that each tube develops its fullest efficiency.

The new Na-ald dials combine rare beauty of design with highest efficiency in use. These dials are moulded from genuine Condensite in such a way that absorption losses are reduced to a minimum. Knobs are so shaped that fingers do not conceal clear numerals and graduation on the bevel of Na-ald dials.

Na-ald Circuit Booklet packed with each Na-ald product

Write for "Why a Bakelite Socket?" and other descriptive literature

## Alden Manufacturing Company

Manufacturers of sockets and dials for every radio requirement  
Dept. K. 52 Willow Street  
SPRINGFIELD, MASS.  
Cable Address, Aldenco



Na-ald Special Socket No. 499 for U.V.199 Tubes, Price 50c

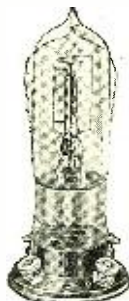

Two-in-One Socket for W.D.11 and 200 Tubes No. 450, Price 50c



No. 3783-3/16" insert 3784-1/4" insert. 378" Dial. Price 75c. 2 and 3" Dials 35c. 3 for \$1.00

teners. At first this idea aroused the ire of the more staid and stable of the members, but finally it was put through to the great satisfaction of all concerned. Within several weeks after the first announcement of the new policy, about 40 BCL's enrolled, and this number gradually crept to 60. Now these members, at a special rate of dues, increased the club's treasury by \$312 a year—a tidy sum.

These fellows did not attend the regular meetings, but had special meetings arranged for them, at which instruction and advice particularly suited to them was given. Some of them brought their sets and had them looked over and their troubles sought out. Others brought their new ideas and circuits and laid them on the floor, where they were discussed and their merits and demerits thrashed out. Larger quarters were not necessary because most of the new members enrolled chiefly for the service that they could receive, rather than for the weekly association, and therefore only about one-half of the membership was at any one time present.

These newcomers were also allowed the privileges of the library and of the workshop; this latter was charged for at the regular fee. If, on account of inexperience, or for any other reason, they could do their own shop work, one of the other members would do the work for them at a slight extra charge. When put on top of the dues, these fees brought the additional money taken in in a year's time, to over \$500

In addition to this, suitable receiving apparatus and a loud speaker were provided on certain nights and between special hours, for the use of those who wanted to get certain stations and did not have the facilities. Quite frequently an open house was arranged, at which the members could take their friends, and have them listen to a special concert, to a prominent speaker, or to the baseball or fight returns.

To sum it all up, the idea helped to bring about a better understanding between the BCL and the amateur. With a better knowledge of his apparatus, the BCL was able to cut out most of the interference which he formerly laid to the amateur, and he became more capable of choosing his circuits and sets, and to more easily find out the trouble when things went wrong. And the amateur became more tolerant and began to respect the rights of his friends, and furthermore began to glory in his increased power and prosperity.

## The Amateur Traffic Problem

(Continued from page 536)

value and importance the traffic that IS handled carries!

A station may handle 350 messages in one month but in 90 per cent of the cases 337 of these will be, "Please QSL card," the entire total of which does not equal the importance of one short message tracing a lost shipment or similar intelligent communication. Right down in your radio hearts YOU know it too—every one of you who really takes the game seriously! Then why, oh why, do you admit the fact and then sneak out to your little shack and brazenly take and forward a dozen more of the rubber-stamp atrocities? It's a downright reflection on your operating ability, for it takes no skill at all to copy a message when all you need pay any attention to is the address and signature; you can guess the text, and on messages of the objectional kind the address and signature merely comprise two groups of call letters. Any cargo grade operator can handle that traffic.



## Add-A-Unit Line

The ideal way of building a Radio Set—least labor, no "fussing"—least cost—and your set is flexible to meet all new conditions, hookups and discoveries as they arise.

Each unit is complete, with its own Bakelite panel, dials, knobs, contact points and wiring. No shopping around for all these parts. Yet you have the excitement of testing out all the new hookups, by making new combinations of these standardized units.

RPM units include:

Variometers mounted and unmounted, variocouplers mounted and unmounted, Coupled Circuit Tuners mounted and unmounted, Detector Units, Audio Frequency Amplifying Units, Radio Frequency Amplifying Units, and a new type mounted or unmounted Variable Condenser—capacity from zero to .0006237 M. F. RPM instruments are all moulded Bakelite. Mounted units come with uniform engraved panels. They are backed by an absolute guarantee of workmanship. Their splendid performance has made every user a proud booster for the RPM Unit Line. Send for our circular of these units and suggested hookups.

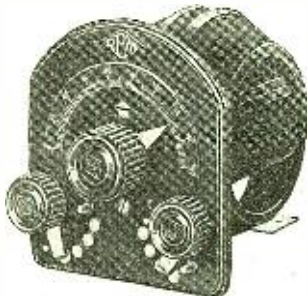
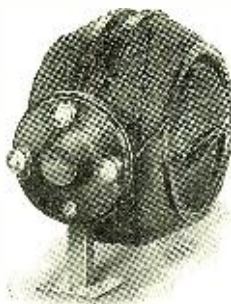

Radio Products Mfg. Co.  
667 West 14<sup>th</sup> St. Chicago, Ill.

## ☸ RADIO ☸

Complete Stock—Both Sets and Parts—  
All Makes  
**ROSE RADIO SUPPLY**  
129 Camp Street New Orleans, La.  
Send 10c for latest catalog

"MASTER" Radio Products  
Manufactured by Radio Division of  
**UNION CONSTRUCTION COMPANY**  
Oakland, California  
Choice Jobbing Territory Still Open.  
Write for particulars

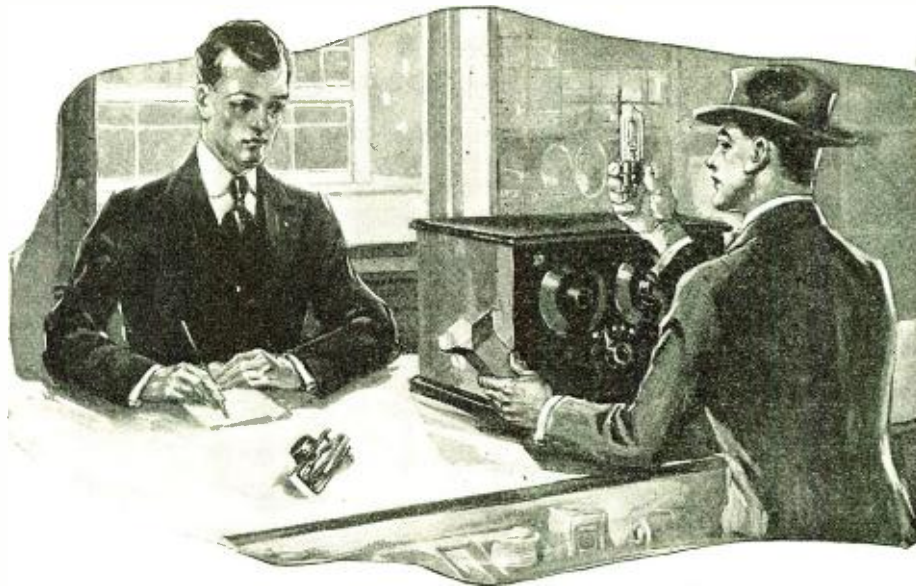

## Every Tube You Buy Should Have the Protection of C-H Control

*There Is a Specialized Rheostat by the Master Builder for Every Requirement*

The Cutler-Hammer engineers, world-famed specialists in electrical control, provided in their now famous C-H Radio Rheostats a new standard in accuracy of design and quality of workmanship among radio instruments.

Outstanding, was their originality of construction. Built almost entirely of non-warping metal—finished in beautiful satin nickel and ebony black—furnished with adjustable, spring contact fingers, comfortable knobs of genuine Thermoplax, and nickeled pointer, these rheostats were quickly recognized as worthy of the trade-mark they carried.

And as the science progressed and new tubes were introduced the C-H engineers evolved new models anticipating every requirement. Today there are four specialized C-H Rheostats (the 4-ohm vernier, the 4-ohm plain, the 30-ohm and the 125-ohm) to control any tube you desire. Each has been designed for the service it must render, and can only be wired to give the voltage needed for the tube it protects. For satisfaction in radio, demand the mark of the master builder on your control instruments.

**THE CUTLER-HAMMER MFG. CO.**

*Member Radio Section, Associated Manufacturers of Electrical Supplies*

MILWAUKEE, WISCONSIN

*One Half Million C-H Radio Rheostats Now in Use*



**"Built by Rheostat Builders"**



**C-H 4-Ohm Radio Rheostat**  
Perfect control for the one ampere, six-volt tubes, or WD 11 (dry cell) type. With vernier, for detector tube control.

Type 11601-H1 . . . . . \$1.50  
Plain type for amplifier tube control.  
Type 11601-H2 . . . . . \$1.00

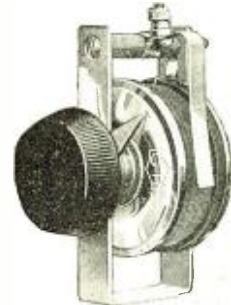

**C-H 30-Ohm Radio Rheostat**  
Precise control of the one-quarter ampere, six-volt (UV 201-A and C 301-A) tubes or the UV 199 type on 4.5-volt source.

Type 11601-H9 . . . . . \$1.50

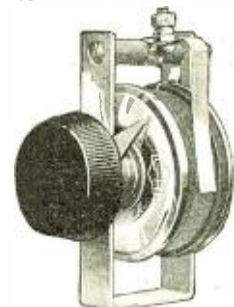

**C-H 125-Ohm Radio Rheostat**  
For control of the current-saving UV 199 tubes on a current source of six volts. Use your storage cell with the new tubes—it will need re-charging only at long intervals.

Type 11601-H . . . . . \$1.50



**C-H Variable Resistance Unit**  
Adds to your five-ohm rheostat just the resistance required to control the 1/4 amp. 6-volt "A" type tubes or the UV 199 type. Saves the cost of new rheostats and the trouble of re-drilling your panel. Fully adjustable for change in battery potential.

Type 11601-H12 . 25c

# CUTLER-HAMMER

# The Perfected Radio Plug

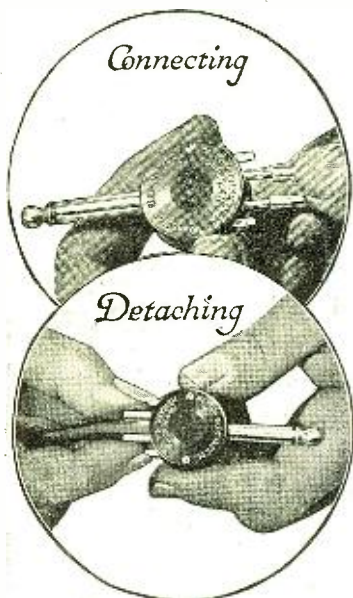

## A Splendid Specimen of Weston Workmanship

So simple, quick and convenient that every owner of a Radio Set will soon be using nothing else.

Illustration shows how terminals attach by merely shoving them into plug. Lower illustration shows how by pressing the triggers toward each other—terminals may be instantly released.

No tools required—no broken fingernails. Perfect contact, always. One plug does the work of several, where quick changes or experimentation is required.

Originally made for the exclusive use of the Weston laboratories in their experimental work. Now, on the market, because this plug was too good to keep from the public.

### At All Dealers

If your dealer cannot supply you, send his name, and we will fill your order direct.

**WESTON ELECTRICAL INSTRUMENT COMPANY**  
173 WESTON AVENUE NEWARK, N. J.

Makers of the World's Standard Electrical Instruments

Electrical  
Indicating  
Instrument  
Authorities  
Since 1888

# WESTON

STANDARD - The World Over

### HELP THE NEWCOMERS

Now that we've brought up the question of operating ability, let's see what this means. Seldom if ever do we hear "QRS" in the air any more. Surely there are just as many or more beginners in the field than ever. Where do they pick up their initial training? It looks as though they've been badly scared, or sneered down by some of the older heads in the game. Have you realized what that attitude leads to, you who had to learn once yourself, but cannot tolerate other beginners? The latter are going to GUESS at what they don't GET and that's a mighty serious fault. Once a man forms the guessing habit, he is doomed as an operator. Suppose he took up operating as a means of livelihood, how long would he last with a commercial concern if he GUESSED at what he missed? What a terrible toll of lives would be taken if a railroad telegraph operator were permitted to GUESS the train orders! Don't be guilty of making a GUESSER of the other man—use the Golden Rule.

If you handle the right kind of traffic, your messages will be of such importance that you can't AFFORD to have them guessed at! As for YOUR individual operating ability, are you quite sure that you are a GOOD operator. Just the faculty of handling the code at a high rate of speed doesn't make an operator. Are you familiar with every one of the Government regulations insofar as they govern amateur stations? Do you know how PROPERLY to call and answer a station? Can you say a great deal in a few well-chosen radio abbreviations? And can you send good, clean-cut signals for a lengthy period at a fair rate of speed without falling all over yourself? Ask yourself these questions—it may surprise you to be honest with yourself!

Here are a few more pointers on actual operation. Why in the world, after once establishing communication with a station, do the majority find it necessary to call such a station ten or a dozen times prior to each transmission? For example, a station has four messages for another. He calls him and receives an acknowledgement and an invitation to proceed with his business. He sends one message. An OK is received and he then calls the receiving station ten or twelve times, signs his own call five or six and follows with another short message. The writer has never yet listened in on a typical amateur receiving set and not been able to find his man right there in the same identical place each time. Why not assume that such a communicating station can do the same with your signals? He doesn't need a long call to find you each time between messages, make your calls short and snappy after communication is once established—other fellows are waiting to use the air.

Here's more—when you have transmitted a message, DON'T go back and repeat the address and signature voluntarily. If the receiving operator misses anything, he will tell you—don't assume that he didn't get it. Give him credit for at least ability equal to yours, or slow down to suit your ability to his.

Perhaps one of the most common present day practices, and to the writer's mind one of the most obnoxious, is the double sending now almost national in adoption. You don't HAVE to send each word twice as a rule! Don't you know that if each word of each message were sent only once, QRM would be cut in two? It doesn't take any kind of an operator at all to copy stuff sent double. QSZ was a signal created exactly for that purpose. If an operator DOES require double sending, he will request that you QSZ. Some of you say, "We have to do it to get through the QRM." Nonsense! Let me repeat—if double sending were eliminated, ex-

## PIONEER" Instruments

### Surpassingly Beautiful

The rich mahogany finish of their molded Bakelite shells, contrasting with the deep green of the silk-wound stators, and both set off by the polished nicked hardware—give "Pioneer" instruments a "class" that instantly attracts every esthetic eye.

They'll make your radio set "look like a thousand dollars" and—their performance will delight you quite as much as their looks.

Variometer - \$6.50  
Variocoupler \$7.00

So internationally popular that we've had to buy and equip a new plant that has quadrupled our producing capacity.

Awarded the Radio News Certificate of Approval, with a high score on every count.

Positive contacts, close coupling and permanent alignment of moving parts. Variocoupler is wound inside the shell like a variometer—an exclusive "Pioneer" feature.

Order from your Dealer or remit direct to us, giving us name and address of dealer you wish to favor.

Circular Free.

**PIONEER RADIO CORPORATION**  
963 Abingdon St. Galesburg, Ill.  
European Branch Office: London, Eng., 27-28 Anning St.  
Gaston E. Marbaix, European Mgr.

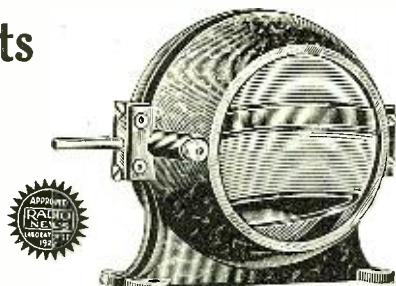

"Pioneer" Variometer—\$6.50

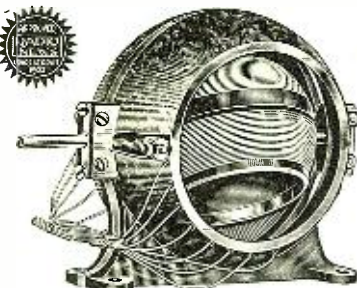

"Pioneer" Variocoupler—\$7.00

Branch Offices:  
New York City, ..... 220 Fulton St.  
Chicago, Ill. .... 33 So. Clinton St.  
Kansas City, Mo. .... 208 Baltimore Bldg.  
Minneapolis, Minn. .... 705 Plymouth Bldg.  
San Francisco, Calif. .... 623 Larkin St.

## RHAMSTINE\*

The Rhamstine\* Victophone replaces the reproducer on your phonograph and transforms it into an ideal loud-speaker. \$7.50 post paid.

**J. THOS. RHAMSTINE\***  
500 Woodbridge East Detroit, Mich.

## \$9.00 Globe Phones for \$4.50

A purchase at a bankruptcy sale enables us to offer 300 pairs Globe Radio Head Phones, 2200 Ohms at \$4.50 per pair. Complete price list of radio parts sent upon request. Aitken Radio Co., 504 Superior Street, Toledo, Ohio.

# "RICO" PRODUCTS

## "RICO" Tuned (Adjustable) Melotone Loud-Speaker

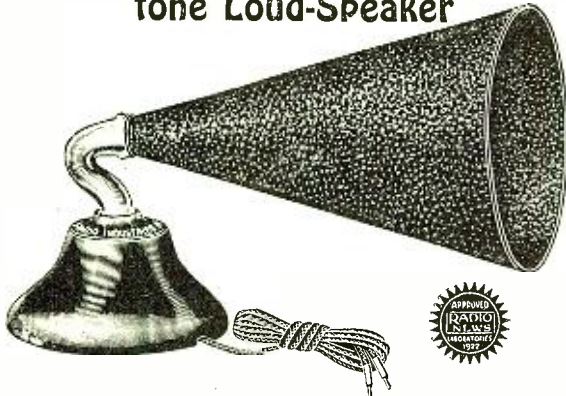

The highest grade, lowest priced, and most popular loud-speaker on the market today. This speaker is equipped with "Rico" TUNED "adjustable" loud-speaker unit. Comes fully equipped with fibre horn, heavy cast base, nickel goose neck and 5 foot cord. This low priced speaker compares well with the most expensive ones. Length of horn 11½"; total height 9".  
No. 220 Melotone Loud-speaker ..... \$6.00

## "RICO" Double Phonodapter



Double Phonodapter  
75c

## "RICO" Fibre Horn Loud-Speaker

Complete  
\$10.50

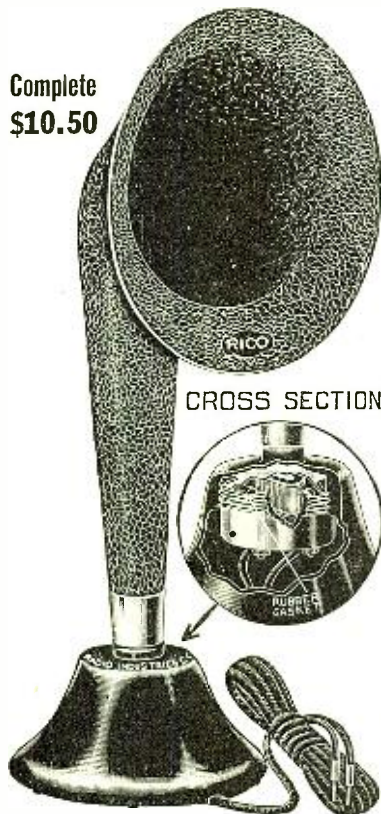

Our highest grade loud-speaker. Horn made of heavy fibre and substantially built. Height 23"; 10" bell. Equipped with No. 25 tuned loud-speaker phone. A wonderful speaker! A wonderful value!

No. 115 Loud-speaker, complete .... \$10.50

## "RICO" Tuned (Adjustable) Loud-Speaker Phone

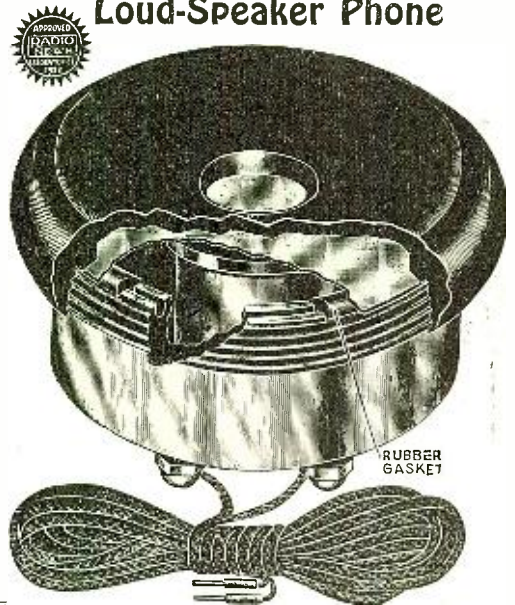

This is the famous "adjustable" loud-speaker phone. A twist of the wrist adjusts sound from low to high. No rattle is possible. Maximum volume. Illustration full size.  
No. 25 Loud-speaker phone ..... \$4.50

RICO

GOODS  
ARE  
GOOD  
GOODS  
BACKED  
BY

RICO

Guarantee

## CAPACITY EQUALS 43 PLATE CONDENSER

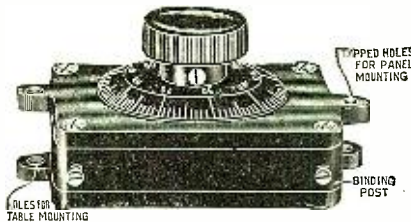

## THE "RICO" STRAIGHT LINE CONDENSER

This condenser marks a revolution in condenser building. It is the simplest and most practical type of condenser as yet developed for broadcast and amateur work. This condenser has been developed by our engineers after considerable research work and has been pronounced perfect by experts.

### SOME OF THE OUTSTANDING POINTS:

- 1—Large capacity (.001 Mf.)
  - 2—Replaces a 43-plate condenser.
  - 3—Uses a minimum of space, size 3½"x2½"x1¾".
  - 4—For panel mounting or for table mounting—universal in its scope.
  - 5—One complete revolution of dial adjusts condenser from minimum to maximum.
  - 6—Vernier effect.
  - 7—Absolute straight line curve.
  - 8—Accumulates no dust between plates as is the case with air condensers—entirely enclosed.
  - 9—Light weight. Condenser only weighs 3 oz.
  - 10—Less than 1-10th amount of parts as used in old style mesh plate condenser.
  - 11—Can never get out of order.
  - 12—Impossible to short circuit.
  - 13—Works in any position, vertical or horizontal. No counterweights needed.
  - 14—Lowest in price for high class condenser.
  - 15—Compactness. Size only 3½"x2½"x1¾" over all.
- The Rico Straight Line Condenser must be seen to be appreciated. Made of the best materials that money can buy. Stands in a class by itself. All metal parts finished in nickel plate.

We will refund your money if this condenser is not all we claim for it.  
No. 450 "Rico" Straight Line Condenser complete with moulded dial ..... \$1.75  
No. 451 the same condenser but without dial (shaft is for ¼ inch) ..... \$1.50

## "RICO" Tuned (Adjustable) Phones

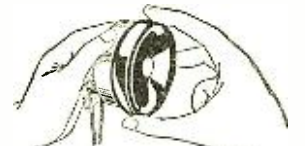

TO TUNE: TIGHTEN or LOOSEN CAP SLIGHTLY



The best phone on the market today. Extremely sensitive with great volume of sound. Only phone made using the new patented adjustable diaphragm. Three pole feature with center pole in mathematical center of diaphragm.  
No. 20—2000 ohm Head set \$6.00  
No. 30—3000 ohm Head set \$7.00

RADIO  
INDUSTRIES  
CORPORATION

131 Duane Street, New York City  
Cable Address: Ricotrade, New York.

Detroit Distributor  
Koploy & Ross, 1244 Randolph St., Detroit, Michigan

## SEND NO MONEY

COUPON R.N.11

Radio Industries Corp.,  
131 Duane Street, New York City.

Gentlemen:—Please send me by Parcel Post.....  
"Rico" ..... for which I will  
pay the postman the amount of.....

Name .....

Street .....

City ..... State .....



# U.S. TOOL CONDENSERS

*Plates and Spacers Chemically Treated to Prevent Oxidizing*

THE greatest enemy of condenser efficiency—oxidizing of plates and spacers—is conquered in U. S. Tool Condensers, as described in the adjoining panel. Years of continual use and exposure leave these condensers unharmed—as perfect as the day they were purchased. Built to maintain a reputation, gained thru years of honest manufacture. Every other feature of these condensers is as thoughtfully evolved. Write for illustrated booklet and the name of the nearest U. S. Tool dealer—TODAY!

Climatic changes eventually spread a film of oxidation over the surface of plates and spacers. A high resistance is set up to the radio frequency currents. U. S. Tool Condensers are protected against oxidation by a patented chemical process, developed after tireless research and experiment.

**U.S. TOOL COMPANY INC.**  
118 Mechanic St.  
Newark, N.J.

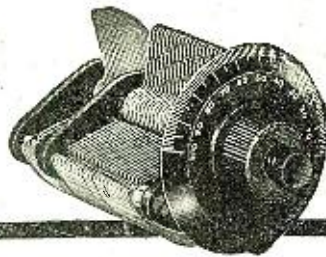

cept on request of the receiving operator, the heavy QRM wouldn't exist. It would be as though 50 per cent of the stations had shut down! Try it!

Now about proper forms for traffic handling. First, if you are going to handle any traffic that amounts to anything, you must include a message number, check, office of origin and filing date. Filing time is optional. Make MESSAGES of your traffic—not NOTES, as now. You already understand and use the message number system; continue to do so. A check prevents loss of words of great importance. Learn how to properly check a message though. Inasmuch as your traffic is all overland and involves no charges, the simplest method would be to adopt the domestic count, that is, counting only the wording in the body as now done by the commercial telegraph companies. Every message MUST come from somewhere—hence an "office of origin." Most communications are of little value unless dated, therefore date 'em. A filing time often helps and is worth while, although it cannot be considered as absolutely necessary. Use your judgment in this connection.

**USE COMMERCIAL METHODS FOR SENDING MESSAGES**

In sending your message in proper form, do it right. When you end one message, if you are sending a group of messages to one station, without waiting for acknowledgment between each, merely make an "AR" after each, following with "KA" and on into the next one. At the end of the series, make "AR" your call letters once, and the letter "K." This signifies to the receiving station that you are through transmitting, have no more business for him and are now ready to receive his traffic. Once this procedure is memorized, the annoyance of a station coming back with an "RRK" after you have finished your traffic to him will be eliminated. Instead, he will merely acknowledge your series and start right in on his.

The form which you use should convey all the necessary information to him without the necessity of your telling him, "That's all OM, clr nw ga urs." Read your United States regulations carefully; all of these points are completely covered in them. And, too, don't make such a difficult, long drawn out process of concluding your communication with a particular station. Ordinarily, enough time is consumed here to put through several more messages. The regulations distinctly state that, "a station shall indicate conclusion of correspondence with a like station by means of the signal 'SK' (sent as one character) on the part of each station, followed by its own call letters." That is all—not another dot! The typical finish among amateur stations is something like this, "Well, OM, gess NM nw, CUL best 73's OM GN SK SK 73." This seems to make it obligatory on the part of the other man to do his share, so he comes back with, "OK OM 73 CUL 73 SK GN." For some unknown reason the first man must also render a long drawn OK for this—oh, I needn't go on—you all know the stuff, but while an exchange of 73's in signing off is not objectionable, even this formality could be dispensed with unless a couple of personal friends are working together. Our object must be to cut QRM to an ABSOLUTE MINIMUM and the only possible way now in view of the thousands of transmitting amateurs in the game, and increasing daily is to eliminate every single unnecessary dot!

Now, how about acknowledging a message? This is also covered by regulation which states that acknowledgment shall be in the form prescribed by the International Telegraph Convention. This consists of the call letters of the transmitting station sent once, the message number or first and last numbers correctly received, the letter R (once or twice), the call letters of the receiving station once, and the signal "K," "SK," or "KA," as fits the condition.

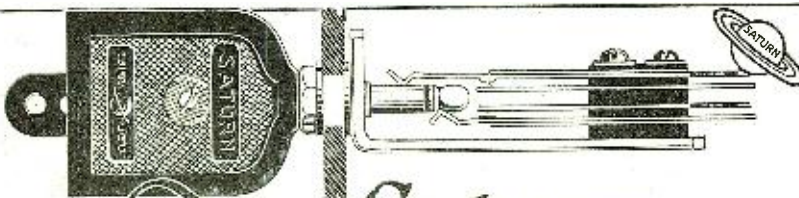

## The Saturn

Above The Ordinary "Radio Products"

**Automatic Plug**

AUTOMATICALLY perfect electrical connection. Made or broken with one swift, simple movement. Terminal tips, held in a vise-like grip that tightens the harder you pull on the cords. Lever instantly releases the tips. Each Saturn Plug fully guaranteed.

LIST PRICE, \$1.00

**Perfect Jack**

CROWFOOT Offset (illustrated in circle below) reduces soldering to utter simplicity. Solder and flux already on blades. Nickel-plated brass bracket with rounded corners. Spring German-silver blades. Sterling silver contact point.

**LIST PRICES**

No. 1	Single Circuit	Open	50c.
No. 2	"	Closed	55c.
No. 3	Double	"	75c.
No. 4	Single Filament	Control	75c.
No. 5	Double	"	90c.

The Saturn Mfg. & Sales Co., Inc.

48 Beekman Street  
New York, N. Y.

A Slight Touch Releases the Tips



**DX-PHANTOM-CIRCUIT**

No Aerial-Ground-Loop required—just a piece of wire laid on floor or ground brings in near and far stations wonderfully free of static and interference. With one tube and 50 feet of wire laid on floor user writes: "I had Chicago, Minneapolis, Denver at 9 a.m. Night reception COAST to COAST. P. Ewing, Hardin, Montana." Vesco simplified circuit is easily operated, but one control for tuning in. Dry cell tube may be used for portable set. Inexpensive to make as few parts are needed. Quickly constructed by the inexperienced from our complete instructions sent postpaid for 25c., including hook-up of two-stage amplifier. Stamps accepted. Box 117 VESCO RADIO SHOP, Oakland, Calif.

## ENGRAVING MACHINES

For RADIO PANELS

And Other Radio Engraving

ENGRAVERS & PRINTERS MACHINERY CO.  
Sag Harbor, N. Y.



—and now this  
**Variable Grid Leak**  
 is added to the line of

**JOS. W. JONES**  
 RADIO  
 TRADE MARK

**IMPROVED**  
 ANTI-CAPACITY

**Radio Jacks and Switches**



Double Filament  
 Control Jack  
 Price \$1.25



Double Circuit  
 Jack  
 Price \$1.00



Single Filament  
 Control Jack  
 Price \$1.00

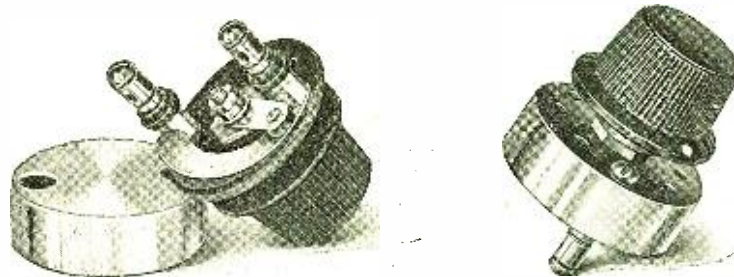

Variable Grid Leak  
 Price \$1.50



Improved "A"  
 Battery Switch  
 Price \$1.00



Open Circuit  
 Price 70 cents

See its compact, sturdy construction—it's built to outlast your set. Continuously variable over a wide range of resistance—from 0 to 10 megohms. A dust-tight aluminum cap prevents accidental damage and assures long, satisfactory service. And, as with all the other Improved radio specialties, there's

**Only One Hole to Drill**  
 —no soldering to do

Improved Radio Jacks and Switches not only save drilling and soldering—they save time, temper and money—they eliminate unsightly contact points on front of panel—give you a neater job—give you better results by reducing capacity effects.

Ask your dealer for the little round jacks and switches with the red button, or write for folder describing the entire line.



Single Pole  
 Double Throw  
 Switch  
 Price \$1.25



Closed Circuit  
 Jack  
 Price 85 cents

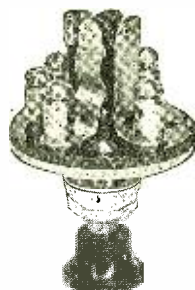

Detector Amplifier  
 Switch  
 Price \$1.50



Inductance Switch  
 Price \$1.85



Double Pole  
 Double Throw  
 Switch  
 Price \$1.60



Series Parallel  
 Switch  
 Price \$1.50

**RADIO IMPROVEMENT CO., Inc., 29 W. 35th St., New York**

# REMLER

## a new and Improved Variometer

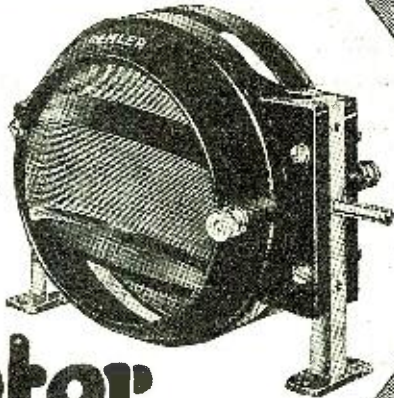

With Internal Pig Tail Connections.  
Wave Length Range 180 to 570  
Meters. Positively Guaranteed.

Type 50  
With  
Closed Rotor  
Price \$7.50

### The Greatest Variometer Ever Produced

#### A Leader in Appearance and Performance

Three years ago Remler introduced the "moulded Bakelite" Variometer. Since that time the engineers of the Remler Company have made a thorough scientific study of the application of variometers to every phase of radio reception. As a result of this exhaustive study a new and improved variometer, the greatest ever produced, is now offered to the public.

It has the lowest minimum and highest maximum wave length ever obtained in a variometer and the wave length variation is exactly proportional to the reading of the dial scale. It will cover the entire range of amateur and broadcast wave lengths when used with any vario-coupler. When used with a Remler vario-coupler the wave length range is guaranteed to be from 180 to at least 570 meters. Pigtailed connections are used between stator and rotor resulting in perfect contact and quiet operation. All metal parts are buffed and nicked; green silk wire is used on both stator and rotor. The general appearance and quality of the bakelite molding is the best ever built into a radio item.

If your dealer cannot supply you send the attached coupon direct to us with express or postal money order. Write for complete descriptive circular.

**Remler Radio Mfg. Co.**  
248 First Street  
San Francisco, Calif.

Gentlemen:

Please send me by return parcel post one new and improved Remler Variometer Type 500 for which I enclose seven dollars and fifty cents (\$7.50). If for any reason whatsoever I am not satisfied with this Variometer, I can return it to you express collect and you will refund my seven dollars and fifty cents in full.

## REMLER RADIO MFG. CO.

Home Office: 248 First St., San Francisco

154 W. Lake St., Chicago 30 Church St., New York City

Name.....

Address.....

**WOC--TRESKO**  
Licensed under Armstrong U. S. Patent No. 1,113,149

A long distance, 1000 mile, 600 meter range regenerative tuner for  
**\$10.00**

Add parcel post on 6 lbs. New circuit startling results. Cheaper than crystal set. Uses any aerial. Amplifiers to match set for your loud speakers. Circuits free—Full instructions.

**TRESKO**  
Tri City Radio Elec. Supply Co.  
BOX 148 DAVENPORT, IOWA

**VACUUM TUBE HOSPITAL**  
We Repair and Guarantee Them

Repairing the following tubes and many others

Vacubub Amplifiers and Detectors  
Moorehead Amplifiers and Detectors  
DeForest Amplifiers and Detectors  
(Cunningham C-299-C-300-C-301-C-301A-C-302)

Radiotron U.-V-199-200-201-201A-202-WD-11-WD-12

Reasonable Prices  
Mail orders solicited and promptly attended to.  
Satisfaction Assured

**GEORGE H. PORELL CO., Inc.**  
Telephone: 7931-R  
SOMERVILLE (44) MASS.

**Print Your Own**  
Cards, circulars, labels, book, paper. Press \$12. Larger \$35. Job press \$50. Save money! Print for others, big profit. All easy, rules sent. Write factory for press catalog, TYPE, cards, etc. **THE PRESS CO., D-72 Meriden, Conn.**

**OLD COINS, LARGE FALL SELLING CATALOGUE** of coins for sale free. Catalogue quoting prices paid for coins, ten cents. William Hesslein, 101K Tremont Street, Boston, Mass.

The writer freely admits that this proper form of acknowledgement is practically unknown, in fact, he does not EVER remember hearing it used either by commercial, naval or amateur stations, either foreign or domestic! It is the PROPER form, however, and is really short and convenient, for it tells the entire story in the fewest possible words. In the event that communication is good, with little or no interference, even just a simple "RK" will generally suffice.

#### MANY MESSAGES ARE NOT DELIVERED

There is another point just as important as any that have gone before, that the writer wishes to touch on. It's an old sore, but apparently has never healed—message delivery. Perhaps it would be more appropriate to say, "non-delivery." Think of all the wasted effort on the part of the conscientious originating and relaying stations when a message is pushed to the city of its destination, generally overcoming terrific handicaps to reach there within a reasonable time limit, only to be delayed many hours, often several days and frequently NEVER delivered by the final receiving station! The writer prides himself on the fact that in all his years of amateur operation, a message reaching his station for delivery or relay never failed to reach the addressee (or next logical relay station) as soon as was humanly possible.

Boys, it's easy! One of the leading amateur publications recently carried a request for suggestions on message delivery. There is a definite system to follow here. If a message reaches your station for delivery in your own city or nearby, in other words, a message that requires no further relay, it's up to you. When you have concluded communication with the station from which you have just copied such messages, THAT is the time to take care of it, not at the end of the evening, nor yet the following morning. If you have telephone facilities, try and locate the addressee by this means. Call on the information operator for assistance if need be. If you are unsuccessful in locating your party, and have definitely established the fact that telephone delivery is impossible, try and pass the message to a reliable local station which is near enough to the addressee to deliver it in person and AT ONCE! Perhaps a little inconvenient, but surely the game is worth it. Failing all else, there is Uncle Sam's postal system, and if you get it in the post office that same night, the chances are nine to one that the addressee will receive the message in the morning mail. Your sole object should be to deliver that message in the quickest possible manner.

The fault most of you make is in holding all the business you may receive for local delivery, until the end of the evening, when it is generally too late to rouse the addressee and you accordingly hold it over until the following day to be delivered at your convenience. Drop that habit—do all that is physically possible to deliver your local traffic within a few minutes of its receipt. You can imagine where the Western Union and Postal companies would be today were they to deliver messages at their convenience. The system as above outlined for message delivery is substantially the same as used by these world famous companies and it has proved its worth. Phone first, then personal delivery where phone fails, and finally U. S. mail where no quicker means is available.

In the case of message delivery, how very few of you know the proper procedure in the event of it being impossible to accomplish such delivery for some reason beyond your control. The answer is—service the station of origin! So few service messages are handled over amateur radio circuits that 99 per cent of you can't recognize them when they ARE offered. There is nothing mysti-

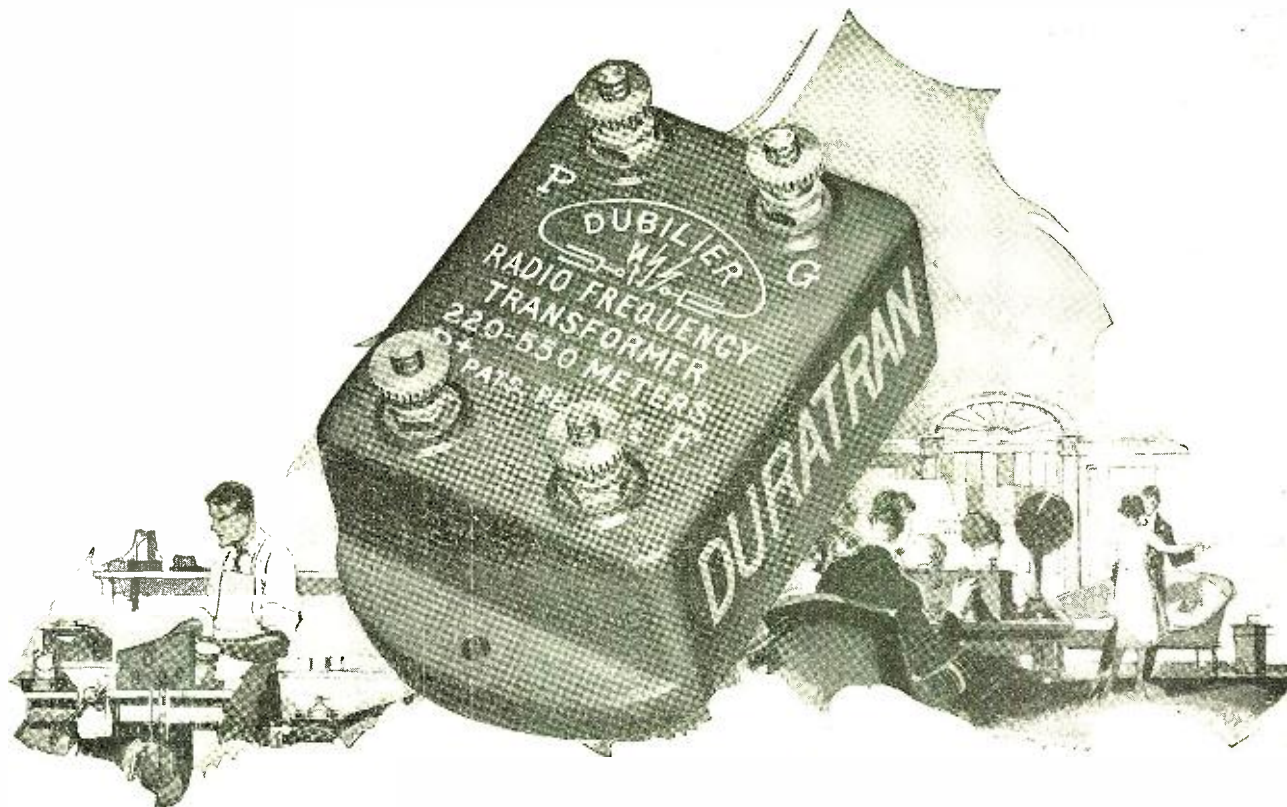

## Why he couldn't hear XZBQ

HE could hear NEN and YST clearly enough on 360 meters. But the 550-meter XZBQ station, broadcasting particularly good programmes, he could hear only faintly.

His set had a radio-frequency transformer with an amplification factor that was good only for the 360-400 meter stations. That was why XZBQ and other 500 and 550 meter stations were almost inaudible.

It is this very difficulty that the Duratran, the new Dubilier radio-frequency transformer, overcomes. It has an amplification factor of over 20 for the entire wave-length band of 220 to 550 meters and amplifies well on an even wider band.

For this reason the Dubilier Duratran will give remarkably good amplification in any circuit requiring a radio-frequency transformer.

**Dubilier Duratran**  
**Price \$5.00**

At all good dealers  
Send for descriptive circular

**Dubilier Condenser & Radio Corp.**

48-50 West Fourth Street, New York

# DUBILIER DEVICES



# CONTINENTAL

"New York's Leading Radio House"

## Radiola Loud Speaker

UZ-1320 reproduces broadcasted programs with clear and undistorted tones.

The magnetic system, the shape of the horn and the material of which it is made are of the very best. Mechanically this unit is very ruggedly built. The finish is of a dull black with a felt base. The bell is  $12\frac{1}{4}$ " in diameter and the height is  $26\frac{1}{2}$ ".

One adjustment is provided for securing maximum efficiency on different values of signal strength.

UZ-1320 LIST PRICE, \$36.50.

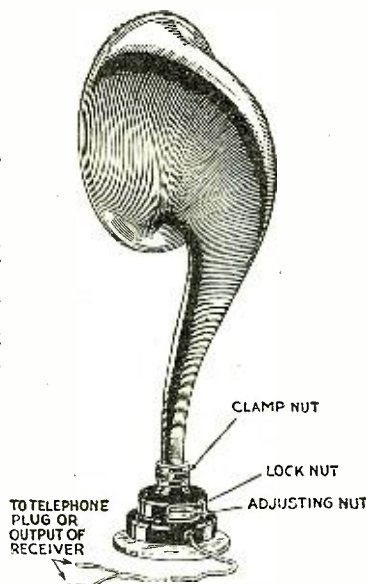

CONTINENTAL RADIO and ELECTRIC CORPORATION  
SIX and FIFTEEN WARREN STREET, NEW YORK, U. S.

## Amplification Perfection

with an audio transformer means PURE TONE  
QUALITY with MAXIMUM VOLUME

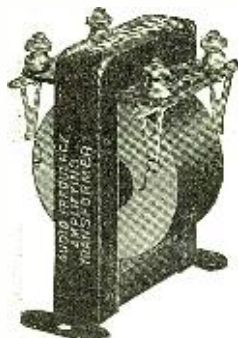

PRICE \$7

Ask your electrical dealer, or sent carriage charges collect. (Wt. 1 lb.)

## The AMERTRAN Audio Transformer

is acknowledged by professional radio engineers to be the STANDARD OF EXCELLENCE for audio amplification.

The reason for the popularity of The AmerTran among professional radio men is apparent in the Amplification Chart shown in our Circular No. 1005.

Turn ratio, 5:1. Amplification ratio, 30-40 times audibility in the flat part of the curve.

American Transformer Company

Designers and builders of radio transformers for over 20 years

177 Emmet St., Newark, N. J.

## NOVO "B" BATTERIES

WITH INSULATED BINDING POSTS  
& DETACHABLE WIRE CONNECTOR  
NOVO MFG CO.

424 W 33<sup>rd</sup> ST. NEW YORK - 531-50 DEARBORN ST. CHICAGO.



TU-WAY PLUG \$1.00

Takes 1-4 head-sets. Does more for a dollar than any other plug, and does it better. Catalogue free.

Carter Radio Co.

207 S. State St. CHICAGO

fying about them. A very elaborate service system is in force by all commercial telegraph and radio companies, using abbreviations similar to your own Q signals to shorten their service messages.

Suppose the address as received by you on a message for A. L. Jones, signed Arthur, was insufficient to effect delivery. Your proper procedure would be to IMMEDIATELY direct a service message to the station from which you received the message in question, such service reading as follows: "To IZE: Yrs date A. L. Jones, signed Arthur undeld GBA-910." This would mean to IZE that the message which he forwarded to you that same date, addressed to A. L. Jones, signed Arthur, was undelivered by you because of insufficient address, the GBA meaning, "Give better address." He would accordingly refer to his copy of the message, change the date of the service if necessary, insert the message number if desirable and forward the altered service to the station from which HE received the original message, signing it with his own call letters. Example: "To 3PZ: Yr nr 3 of 19th Jones signed Arthur undeld GBA-IZE." This service eventually gets back to the originating office which, by getting in touch with the person filing the message, is enabled to secure a corrected address. He, therefore, starts the answer back: "To IZE: SYS (See your service) date our nr 3 of 19th Jones signed Arthur correct adds 319 Court St., Chicago, Ill.-3PZ." By the same relay system, 910 is supplied with the corrected address and is enabled to effect delivery, which, while delayed, gives the game a much better boost than no delivery at all. Perhaps you think this an unnecessary amount of trouble. Boys, it's SYSTEM, and if you don't want to handle traffic systematically, you should get out of the game—you are contributing to its eventual downfall—inevitable if improvement isn't evident very soon!

There is another service system which must not be confused with the above described method. This is a method used by the commercial companies to show on the face of a message transmitted just how such transmission was accomplished. In practice the operator, while sending with his right hand, makes certain rough characters on the face of the message with his left. The common form of such notation is as follows: "1 3IW YB NX 11.10 p.m. 17th." Interpreted this means "message number one to station 3IW, sent by operator YB, received by operator NX, sent at 11.10 p.m. on the 17th." Form this habit also; you thereby have every necessary bit of information directly on the message form, enabling instant reference to any questioned point. It is difficult to learn to "service" a message with your left hand while sending with your right, but you can do it with practice. It is not necessary, of course, for you can make the notation between transmissions, in a few seconds.

Every operator should adopt a personal sine of one or two letters—most of you do, so we will pass over this. Suffice it to say that it helps enormously in tracing a message, as well as in passing your traffic if you know who the other man is.

The foregoing touches on the more important points and serious mistakes in the amateur world today. There are numerous others—long, useless calls, unnecessary CQ'ing and many of the more familiar breaches of good operating. These, too, you must iron out. The writer by no means wishes to convey the impression that he discourages amateur radio—just the opposite. It is a grand and glorious game, and the writer derives an immense amount of enjoyment from his own amateur station. The purpose of this article is to endeavor to point out the necessity for putting amateur radio on a business-like basis for the good of the game. It will take a very high order of co-opera-

# ATWATER KENT

## RADIO EQUIPMENT

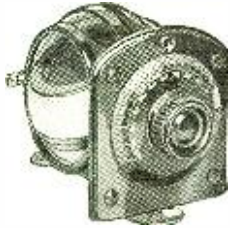

Mounted Variometer

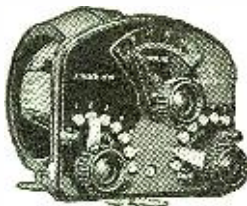

Mounted Variocoupler



Type 11 Tuner



Detector 2-stage Amplifier

ATWATER KENT Radio Sets and Parts embrace a variety sufficiently wide to meet the requirements of every user of radio.

Sets commence with the simplest combination of tuner and detector unit, and include the most complete arrangement of radio and audio amplification that has been found practical.

Parts include every instrument necessary to the assembling of complete sets.

Every instrument is designed and made in the ATWATER KENT plant and represents the accumulated experience of more than 25 years in the design and manufacture of electrical equipment.

Literature describing the entire line of Atwater Kent Radio Sets and Parts sent on request.



2-stage Amplifier



Variable Condenser  
Table Mounting, Top Control



Variable Condenser  
Table Mounting, Front Control

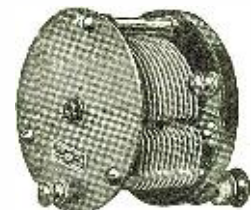

Variable Condenser  
Panel Mounting

ATWATER KENT MANUFACTURING COMPANY, PHILADELPHIA, PA.  
4943 STENTON AVENUE

Makers of  
THE WORLD'S HIGHEST GRADE IGNITION  
STARTING AND LIGHTING

# DELTA

## Gold-Stripe Radio Headsets

"GUARANTEED ABSOLUTELY EQUAL OR SUPERIOR TO OTHER STANDARD MAKES AT MUCH HIGHER PRICES"

No. 500  
2200 Ohm  
**\$6.00**

No. 501  
3200 Ohm  
**\$6.50**



Reproduces clearly and Naturally. There's no "fuzz" or "tinny tone." DELTA Gold-Stripe Headsets are known to be extremely sensitive.

An Institution of 13 Years Standing.

DEALERS and JOBBERS:

Stock now for winter.

Demand assured. Write for discounts.

RADIO APPARATUS FOR THE WORLD



Home of Nationally Famed Delta Electric Products.

### DELTA ELECTRIC COMPANY

470 Delta Block Marion, Ind.

Standard Makers of Radio Apparatus, Bicycle Lamps, Auto Spotlights, Lanterns, Flashlights and Flashlight Batteries

NEW YORK SAN FRANCISCO WINNIPEG



## MARKO "A" BATTERY

90 AMP. HRS.

IN RUBBERLITH CASE

Highly Ornamental As Well As Efficient

The Rubberlith case is a composition case with a high gloss giving the appearance of ebony. It is moulded in one piece, including handles and cells—no jars to break—and is practically indestructible. A worthy addition to your set.

ALL SIZES, FROM 2 VOLT BATTERIES UP, CARRIED IN MAHOGANY FINISH CASES

SOLD BY

MANHATTAN ELECTRICAL SUPPLY CO., 17 Park Place, New York, N. Y.

STANLEY & PATTERSON, 23 Murray St., New York, N. Y.

J. H. BUNNELL & CO., 32 Park Place, New York, N. Y.

PACENT ELECTRIC CO., 22 Park Place, New York, N. Y.

ALSO RADIO SUPPLY STORES AND ALL MARKO SERVICE STATIONS

MADE BY

## MARKO STORAGE BATTERY CO.

1402 ATLANTIC AVENUE, BROOKLYN, N. Y.

Branch, Jefferson at Bedford Ave., Brooklyn, N. Y.

210 W. 54th St., New York, N. Y.

### IF YOU HAD A FRIEND IN NEW YORK

who would buy whatever radio equipment you needed from the smallest part to the complete set either assembled or un-assembled—who would personally test each article you desired—who would gladly and freely advise you when you needed help—who was not interested in any radio manufacturer—who carried out your instructions to the letter and did it promptly, prepaying all shipping charges—and at prices less than if you did your own buying—he would be a real friend indeed! Well, here he is—write at once and get acquainted with the friendly service and money-saving story of the PERSONAL SERVICE PURCHASING BUREAU, Dept. 15—505 Fifth Avenue, New York City.

### THEORY & OPERATION OF REFLEX CIRCUITS 25¢

by EDWIN S. WATKINS  
A practical book by a practical man who knows. Tells the WHY and HOW of the most powerful radio circuits in existence. Describes the construction of SIX different sets including the famous NEUTRODYNE. Distance fades away when using a REFLEX. Order your copy now. 25¢ Postpaid. THE WIRELESS SHOP, 1263 W. 2ND ST., LOS ANGELES, CALIF.

tion to do it, but are you, as amateurs, going to pronounce it hopeless and continue your aimless drifting without giving the BUSINESS of amateur radio a fair trial?

The writer willingly shoulders all the deep mutterings and criticisms that will undoubtedly be heaped upon him for these words if this starts even the smallest movement towards BUSINESSLIKE AMATEUR RADIO! I thank you!

### Some Power Considerations in Radio Transmission

(Continued from page 534)

The second parenthesis is a measure of the radiating power of the transmitter and is known as the meter-amperes product. A trans-Oceanic station usually has a meter-amperes rating of 30,000 or more. The figure given would correspond to an antenna height of 100 meters, and a current of 300 amperes in the ground lead. Broadcasting stations run much lower; the average 500-watt set, for example, may have an antenna height of say 30 meters, with 8 amperes at the base of the antenna, corresponding to about 250 meter-amperes. As for amateur transmitters, with a current of 3 amperes and say 15 meters height, quite a number have spanned the ocean with less than 50 meter-amperes—when the spanning was good. It may be mentioned that these figures are for actual antenna height, and that often the Austin-Cohen formula is given with a constant 120<sup>7</sup>, which is twice as great as the 188 in the version used in this article. In that case "effective" or electrical antenna height is used, and this is generally about half the physical height, so that in reality the two formulae are the same.

At the receiving end the antenna height also influences the received signal, but static disturbances increase in the same proportion, so that in practice there is no advantage in raising h<sub>r</sub> indefinitely. The receiving antenna should have as low a resistance as possible, since the factor R appears in the denominator of the equation. The usual way of decreasing R is by employing regeneration; by this means the resistance may be made to approach zero, and at the same time the tuning is sharpened by the lowering of the decrement of the receiving system.

For actual results in practice the simple transmission formula must be modified by a factor

$$e \frac{0.000047}{\sqrt{\lambda}}, \text{ e being } 2.718.$$

This must be divided into the denominator of the right-hand side of the equation, and its effect is to make I<sub>r</sub> much lower for a given value of "d." Also, with lower wavelengths the value of the absorption factor increases, and there is some optimum value at which, for the given distance, I<sub>r</sub> will be a maximum, and this is known as the optimum wave-length for that distance. For a very long distance, say 7,000 miles, the optimum wave-length will be of the order of 20,000 or 30,000 meters. But when there is no absorption, then obviously it is highly advantageous to be working on a low wave-length, since then the sample formula holds, and λ appears only as a first power in the denominator. The modified formula as above gives results for daylight, when absorption is a maximum.

A simple physical analogy for broadcast or amateur telegraph transmission as we know it today would be the case of a liquid welling up out of a pipe at a constant rate, and spreading over a flat plane of some porous material. Now imagine that in some directions, at times, the material becomes impervious to the liquid; then at points along these channels the rate of flow of the liquid

would be much greater. This corresponds to the favorable conditions of night reception when distance records are made. A condition when the liquid is uniformly soaked up in all directions would correspond to daylight radio transmission, and, of course, during this interval the liquid would not get out nearly as far from its source unless the rate of emission was greatly increased.

Fig. 1 shows graphically the effect of absorption at the lower wave-lengths. The curves are re-drawn from a logarithmic graph in the very instructive paper of Messrs. Nichols and Espenschied already cited. The upper curve shows the strength of the received field at Elberon, computed according to the formula, without taking absorption into account. The lower curve includes the absorption factor. It was found by actual measurements of the received energy that the strength of the field from the ship fluctuated between these two curves, falling to the lower line during the day, and rising at favorable times during the night to the upper line.

Analysis of these curves brings out the following facts: If we assume, with the authors, that a minimum field strength of 200 micro-amperes per meter is necessary for reliable telephone communication, under absorption conditions, the range is limited to 400 kilometers, or 250 miles. The upper curve in Fig. 1 falls to the same level at 1,100 kilometers, or 700 miles. As far as real distance reception is concerned, at about 1,200 miles the absorption curve is run down to the zero line, while the non-absorption curve is still well up in signal and falling very slowly. Its characteristic is such that for double the distance the signal drops only to half the value, and so on. "It is therefore seen," the writers conclude, "that many if not all of the long distance transmissions which have been realized for short periods of time probably can be explained simply on the basis of there having occurred an exceptional clearing up of absorption at a time of unusually favorable interference conditions." In other words, DX records on short waves are the result of some receiver picking up the energy which is normally absorbed by the atmosphere, at a time when, through some obscure and transitory physical change, the atmosphere does not take its usual toll from the passing electric wave.

Among other energy relationships which are not always clear to experimenters is the matter of detector response, which is tied up directly with the matters discussed above. Everyone who follows the literature has seen references to an alleged threshold value below which a detector will not work, hence the desirability of radio frequency amplification before the rectifier. R. F. amplification is indeed valuable, but the actual reason for its efficacy lies in the square law response of detectors. Fig. 2 shows how the response of a detector varies with the received current. The steepness of the curve increases at higher currents and voltages. If we supply a voltage equivalent to 10 microamperes of received current to the detector, we get a response of less than half an audibility unit. If we supply 80 microamperes, after say one step of R. F., we get an audible response of 20 units. By increasing our input 8-fold, we can increase the output 40-fold. It is a matter of a larger investment yielding a greater percentage return than a small outlay. The effect is the same as if the detector "lay down" at some definite point and did not function below this level, but actually the existence of this point is a myth, and the explanation is found in the square law of response.

The only detector which does not follow the square law is the oscillating tube. This has a straight line characteristic, and it can readily be seen, by comparison with Fig. 2, how much more favorable to weak signals

The  
Supreme  
Insulation

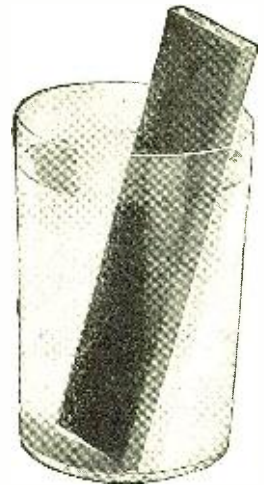

# RADION Panels

are  
impervious to  
moisture

Moisture is a conductor of radio frequency currents. When a panel or part absorbs moisture from the air it causes short circuits between terminals. These short circuits reduce volume and frequently are the cause of distortion.

Tests have proved Radion Panels impervious to moisture. Try them and notice the difference.

Send 15c for sample test pieces 2 x 3 inches.

## 18 Stock Size Panels

Radion being an insulation material especially made for wireless use, has the lowest phase angle difference, lowest dielectric constant, highest resistivity and supreme moisture, gas and acid repelling properties.

American Hard Rubber Co.  
11 Mercer Street, New York

# RADION

Panels - Dials - Knobs - Sockets - Insulators

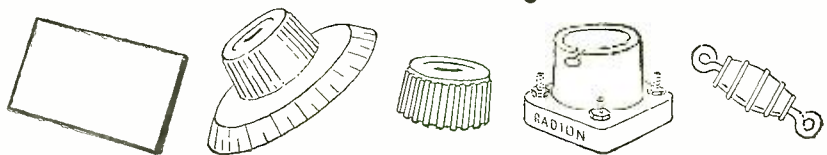

# The Thousands of Users

The thousands of users of C R L Adjustable Grid Leaks will be interested in the newest C R L product—a potentiometer in which the same patented features found in the Grid Leak have been incorporated. The resistance is adjustable without steps to produce the finest graduations, and is absolutely non-inductive.

## New Type of Potentiometer No Choking Back of Radio Waves

The new C R L Potentiometer has no wire-wound coil to choke back or retard the high frequency radio waves. It is built with a pure graphite resistance strip that will not deteriorate or change its characteristics. The absence of coils of fine wire eliminates all trouble from loose turns.

A transparent cover over the working parts protects these parts from dust and moisture and permits a clear view of the interior. A patented pressure contact insures noiseless operation and prevents any wear of the resistance element.

The same method of mounting which has made the C R L Grid Leak so popular is used—Drill only one hole in the panel and mount either instrument in a jiffy.

*Every instrument carefully tested before it leaves the factory.*

- No. 110 (400 ohms maximum resistance) .....\$1.75
- No. 111 (2000 ohms maximum resistance) ..... 2.00

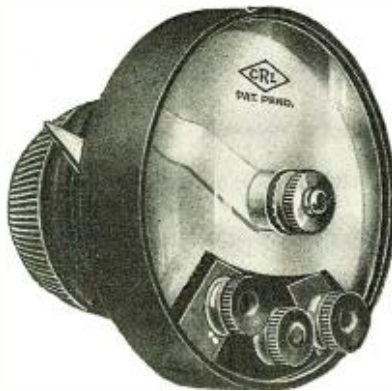

C R L Non-Inductive Potentiometer  
Patented March 13, 1923.  
Other Patents Pending

**Central Radio Laboratories**  
305 16th Street Milwaukee, Wis.

# POTENTIOMETERS — Non-Inductive —



## Bristol One Stage Power Amplifier

A unit that can be used as a third stage without howling. The usual objections against a third stage of audio frequency amplification are entirely eliminated by the use of the new "impact" circuit.

The Bristol One Stage Power Amplifier does not require separate "A" or "B" battery. It uses common tubes such as U.V. 201A, 216A and V.T.2.

A remarkable achievement—a third stage audio that works RIGHT—install one today and give that distant station a chance to come in like the locals.

Ask your dealer or send for bulletin 3006-S.

Give your loud speaker a treat.

**THE BRISTOL COMPANY**  
Waterbury, Conn.

BRANCH OFFICES:  
Boston New York Pittsburgh Philadelphia Detroit Chicago St. Louis San Francisco

**MONTROSE CONDENSERS**

- 11 Plate Vernier.....\$2.20
- 23 Plate Vernier..... 2.55
- 43 Plate Vernier..... 3.25
- 3 Plate Condenser..... .75
- 11 Plate Condenser..... 1.20
- 23 Plate Condenser..... 1.55
- 43 Plate Condenser..... 2.00
- .00025 mfd. Bal. Vernier 2.70
- .0005 mfd. Bal. Vernier 3.30
- .001 mfd. Bal. Vernier 4.00

**MONTROSE MFG. CO.**  
1200 Bedford Ave. Brooklyn, N. Y.

**199 NECESSITIES**

- WIMCO 199 SOCKET .....\$.75
- WIMCO 199 C SOCKET ..... 1.00
- WIMCO 199 ADAPTER ..... .75

Send for free literature.  
Jobbers' inquiries solicited.  
**THE WIRELESS MFG. CO., Canton, Ohio**  
MANUFACTURERS—DISTRIBUTORS

such a characteristic is. It is equally hospitable to all signals, and treats them all alike, giving the weak as much response, in proportion, as the strong, while other forms of detectors than the heterodyne favor strong signals. This gives telegraph reception of C. W. signals, as used by amateurs, an advantage over telephone listeners, and explains why the amateurs in general cover greater distances with lower power than the broadcasting stations. Of course, the B. C. L.'s also use heterodyne reception, at times, but the resulting speech is usually so distorted that there is no gain in range, and the resulting interference with other listeners is known to everyone.

For commercial radio telephone reception a field strength of 200 micro-volts per meter is needed, which, with a 10-meter receiving antenna, would correspond to a total received voltage of 2,000 micro-volts. If the antenna resistance is 25 ohms, the received antenna current would be 80 micro-amperes. But for freak reception probably a few micro-amperes, or even a fraction of a micro-ampere, is probably sufficient in the absence of QRM at the receiving station, and this ratio is a fair measure of reception from a nearby broadcasting station, or a local amateur, as compared to long range work on the same waves.

It is only a matter of time when all advanced amateurs will analyze the power problems of radio transmission along the lines outlined in this article, just as the amateurs of today rate their antenna power in terms of watts in the antenna, where their predecessors spoke of two-inch spark coils and the like. The advantage of exact methods is that one knows where one is at. Using the principles discussed, one knows that if a broadcasting station doubles its power it will be heard twice as loudly, although the new antenna current will be only 1.41 (the square-root of 2) times the old. If a C. W. telegraph station doubles its power, the increase in the antenna current will be the same, but the station will get through only 1.41 times as loud, to receivers using heterodyne reception. Knowing the underlying principles, an amateur can predict the improvement to be expected if he changes from a five-watt to a 20-watt transmitter, and make numerous other practical calculations, while without an understanding of the relation of power and sending current to range and received current he is about in the position of a man who wants to become an international banker, but does not know anything about foreign exchange.

## The Nerve System of the Sea

(Continued from page 522)

bearings to vessels. The system is regarded as the most accurate in the world, being capable of giving bearings within one-tenth of a degree. Approximately 90,000 bearings were furnished to vessels during the past year. By the use of the more recently developed system of radio compass bearings the captain of a vessel may determine his own bearing by radio.

The principal radio stations of the Navy on the Atlantic Coast are at Bar Harbor, Sayville, L. I., Annapolis, Arlington, Cayey, P. R., Guantanamo, C. Z., and Panama. There are also a large number of coastal stations. The Bar Harbor station receives all messages from Europe, and from the fleet. The messages are then relayed by leased wire to Washington. The Sayville station is used as a transmitting station to the fleet and as a standby for Annapolis. Annapolis is the principal Atlantic Coast transmitting station to Europe and to the Pacific. Both



the Annapolis and Sayville stations are operated by remote control from Washington. The stations in the Canal Zone are under Naval control according to agreement with the Republic of Panama which provides for the broadcasting of entertainment programs as well as official business.

In the Pacific, the Naval radio service is practically the only means of handling press dispatches, the Associated Press sending on an average of about 1,000 words daily from San Francisco to Honolulu and about 800 words to Manila. Several radio circuits are maintained by the Navy in the Pacific, but the chief one both in length and volume of traffic handled operates between San Francisco and the Philippines. A half-hourly schedule is maintained between San Francisco and Honolulu. There are stations also at Guam and Cavite, and at Tuaila in the Samoan Islands.

The Cavite station is in constant communication with French Indo-China and the Dutch East Indies. Northward from Cavite, circuits to Peking and Shanghai are maintained. Eastbound trans-Pacific traffic is sent direct from Cavite to San Francisco. In Alaska the main Naval radio stations are at Sitka, Ketchikan, Seward, Kodiak, Cordova, Dutch Harbor, and St. Paul. As the Alaskan cable is often out of commission, the Navy's radio chain is frequently called to accept commercial messages for the Northwest.

Nearly 1,000,000 words a month for the Navy, and 240,000 words for other Government departments are handled at the Washington radio office through which all incoming and outgoing dispatches for central Government bureaus are transmitted. A conservative estimate places the annual number of words handled at 15,000,000. The Navy is the largest user of the service, the Department of Agriculture next, with around 2,000,000 words, followed by the State and War Departments. Based on commercial rates it is estimated that the Washington service annually handles a total of more than \$4,000,000 worth of business.

In addition to the Governmental and public services rendered by the Navy's radio organization, the Navy has played a leading part in the field of radio research. The policy pursued has been one of close co-operation with manufacturing companies in designing and producing equipment. The improved spark gaps and wave changers were called for in Naval specifications several years before the desired type was finally developed. A number of designers were trained by the Navy to learn naval conditions and requirements, and the radio apparatus designed became the standard for similar apparatus used on merchant vessels. Testing laboratories are maintained as an aid to manufacturers in keeping equipment up to standard. The development of efficient insulators for use on high-voltage power lines all over the world is a Navy accomplishment resulting from experiments with porcelain and composition insulators used to support radio antenna.

Outstanding results have been obtained by the Navy in designing radio antenna and in constructing self-supporting radio towers. The design of the 600' and 450' steel towers at the Arlington station has been followed at all high-power Navy stations, and has been adopted by commercial companies. Considerable research study has been made of atmospheric disturbances and wavelengths. A system for the automatic relaying by radio of received signals has been developed. For example, the Arlington station transmits time signals on 2,650 meters and the messages are automatically relayed by the Anacostia station on wavelengths of 360 to 412 meters. High speed transmitting and recording systems have also been developed.



## Only the Set You Build Will Suit You

If you have just half the soul of a real radio fan, a complete, ready made set will pall on you in a week. Build your own!

You want radio performance, to be sure, but you want it of your own creation. What so fascinating as to plan, to assemble, to adjust and construct? And finally to get the radio results and the set compactness made possible by this splendid line of distinctive parts—different and better.



**New Coto Compact Vernier Condenser**

Only 2 3/4 inches square. Rotor plates soldered to shaft. Stator plates soldered at three points. .0005, \$5.00; .001, \$6.00.



**Demand Coto!  
Get Coto!**

### New Coto Compact VARIOMETER

Especially designed for new wavelengths, 200 to 600 meters and for the much demanded compactness. Size 3 1/2 x 3 3/4 x 1 1/2 in. In brown polished bakelite with honeycomb wound stator. Beautiful in action and appearance. Base or panel mount. Type 8000, \$5.00.



**New Coto Compact Variocoupler**

Twin sister of the Variometer. Size only 3 1/4 x 3 x 3 3/4 in. Range 200 to 600 meters. Base or panel mount. Type 9000, \$5.50.

**Jobbers! Dealers!**

The Coto line has the efficiency, the appearance and the advertising for big selling. Write at once for latest Price and Discount List.



**Coto Special Audio Frequency Transformer**

Turn ratio of 3 to 1. Coto quality throughout but made to sell at a popular price. Type 4500, \$2.50.

## Coto-Coil Co.

87 Willard Ave.  
Providence, R. I.

Pacific Coast Branch,  
329 Union League Bldg., Los Angeles, Cal.

Northwestern Branch,  
Geo. F. Darling, 705 Plymouth Bldg.,  
Minneapolis, Minn.

Southeastern Branch,  
C. P. Atkinson, Atlanta Trust Co. Bldg.,  
Atlanta, Ga.



**The Original Honeycomb Wound Inductance Units**

Popular low priced favorites of the amateur and experimenter. Descendants of the Coto Coils that guided the N. C. navy planes across the Atlantic. Sold mounted or unmounted.



**Cotogrip Tube Socket**

Has unique double positive grip of tube terminal posts. Best hard rubber insulation. Type 7000, 85c.

## RADIO VETERANS DEMAND

**\$7.65**  
"Professional"



The finest instrument of its kind that money and science can produce. Molded Bakelite cases and ear caps; single bar Tungsten steel magnets; light weight; exceptional tone and volume. Δ \$12.00 quality for \$7.65.

**\$10.00**  
**ACOUSTICOLA**  
Phonograph Attachment

**TRIMM**

**Head Sets**

Positively the only headset on the market sold with a lifetime guarantee that covers every detail of materials and workmanship—excepting only cords and shells which cannot be guaranteed against breakage if dropped. Absolutely no charge AT ANY TIME for repairs, replacements or for re-magnetizing.  
The head sets to buy; the head sets to sell.

**See! Hear! the**  
**TRIMM**  
**LOUD**  
**TALKERS**

**\$22.50**  
Composition Horn  
**ACOUSTICOLA**

**\$5.00**  
"Dependable"



Standard bi-polar construction. Aluminum case. Splendid finish; beautiful appearance. Wonderful volume and clarity of tone. Compare the Trimm "DEPENDABLE" with any \$6.50 to \$8.00 headset on the market. Money back if not satisfied with any TRIMM product.

**\$35.00**  
**ACOUSTICOLA**  
**GRAND**  
With Cast Aluminum Horn

All fitted with Special TRIMM jumbo size Loud Talker Unit. Write for folder. Or order samples with privilege of return after 5 days' examination and test.

**Trimm Radio Mfg. Co. Dept. 24**      24-30 S. Clinton St., CHICAGO, ILL.

The radio compass is regarded as a crowning achievement of the Navy's radio work. In 1912 the department began to experiment with various proposed schemes for obtaining directions of radio signals. The various methods proposed were found unsuitable for use on shipboard, and manufacturers were invited to work out the problem in co-operation with Government engineers. The radio compass coil developed by the Bureau of Standards resulted. The apparatus was redesigned in naval laboratories to meet shipboard conditions and in 1916, 20 sets were installed in the fleet. An elaborate shore compass system was also installed during the war and many vessels were fitted for use in detecting enemy vessels. Since the war, the system has been further perfected for both military and navigational purposes. It is estimated that at least 15 ships were saved by this system from running aground during the past year.

### Amateur Radio in the Orient

(Continued from page 538)

through it and fight for something better. One of the Hong Kong papers contained a very interesting story of a meeting held there at the time of my visit. It is indeed worthy of note, so the complete article follows, for your perusal:

"There came into being at the City Hall yesterday evening a Hong Kong Radio Club. A public meeting convened by the Hong Kong Telegraph was held for the purpose, and a large number of enthusiasts attended. The chair was taken by Mr. F. Hicks, who was supported by Mr. B. Wylie, and Mr. F. J. Franklin.

"The Chairman, explaining the objects of the meeting, expressed the hope that if the meeting should decide to start a Club it would concentrate its activities on research and experimental work rather than on what might be termed the amusing side of radio. There would, of course, be people to whom radio would appeal as a fad, a novelty or a rather elaborate toy, but for the scientifically-minded there would be much more in it than that. The chief aim of the Club, he suggested, should be to help forward the development of wireless communication, to improve the knowledge of its members by experimental activity, and, perhaps, in this way to render some service in the perfecting of radio apparatus. In this connection, it is a most fortunate circumstance that amongst those who had sent in their names as being willing to join the Club were quite a number with expert knowledge of the subject. This knowledge they were quite prepared to place at the disposal of the members, and under the guidance of such experts the new organization should have a most beneficial future. One of the very first duties of the Club, when formed, he said, would be to set about securing adequate Club premises. A room would necessarily be required where members could not only meet for exchange of ideas, but where demonstrations, instruction and lectures could be given.

"The following resolution was passed on the proposition of Mr. Orchard, seconded by Mr. Ribeiro: 'In the opinion of this meeting Hong Kong should have a Radio Club, and that this club be duly formed by the present meeting.'

"The chairman informed the meeting that he had received 93 letters from people wishing to become members of the Club, and he formally moved that they be provisionally enrolled.

"Mr. Taylor seconded, and the motion was carried unanimously.



# Sodion

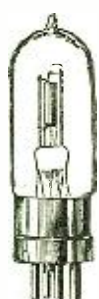

### We Repair The Following Radio Tubes

WD-11 .....\$3.50	UV-199 .....\$3.50
WD-12 ..... 3.50	C-299 ..... 3.50
UV-200 ..... 2.50	UV-201A ..... 3.75
UV-201 ..... 3.00	C-301A ..... 3.75
C-300 ..... 2.50	UV-202 ..... 4.00
C-301 ..... 3.00	C-302 ..... 4.00
DV-6 ..... 3.00	DV-6A ..... 3.75

Dealers & Agents write for Special Discount  
Mail Orders solicited  
and promptly attended to.

**H. & H. RADIO CO.**

P. O. BOX 22-H  
Clinton Hill Sta.      Newark, N. J.

### Why Pay More ?

GENUINE R.C.A. TUBES

W.D. 11    **\$5.95**    UV-199  
W.D. 12                  UV-201A

ALL NEW, NO STAMPS, NO C.O.D.  
BALDWIN PHONES \$9.75

Send for our New Price List  
with many other items.

Save Money By Buying From Us

**CUT RATE RADIO CO.**

P. O. Box 472      Newark, N. J.

"The following officers were elected:— President, Mr. J. H. Donnithorne of the China Light and Power Company; Vice-president, Mr. R. M. Smith; Secretary and Treasurer, Mr. O. Tollan.

"It was decided that the Committee, for the time being at least should consist of only four other members in addition to the officials already elected. The four were Messrs. J. M. Jack, Taylor, A. B. Raworth, and W. E. Orchard.

"The chairman, while the ballot for committee was in progress, remarked that they could get in touch with the Shanghai Radio Club, and get a few ideas from them. They could hold another meeting at a later date and decide as to rules and regulations, etc.

"A member of the audience asked whether there were any thoughts as to the description of sets to be used, and whether they would not make some attempt to see that the sets imported were of British manufacture.

"The chairman expressed a doubt as to whether the question was one which should really be raised at this particular meeting.

"One gentleman remarked that he believed there was a clause in the agreement between the Broadcasting Company at the Home, and the Home Government, that all the sets, etc., used in the British Isles should be of British manufacture and he thought something of the sort might be urged upon the Hong Kong Government.—(Applause.)

"The matter was dropped.

"Replying to a question as to whether any move had been made with regard to obtaining a Provisional License from the Government for firms desiring to broadcast, Mr. W. E. Orchard, electrician of the Hong Kong Hotel Company, stated that if the Club would petition the Government on this particular matter the Hong Kong Hotel Company would be prepared to broadcast free of all charge. He understood the Colonial Secretary was waiting for instruction on the whole question from Home. They would not guarantee their programs, however, unless they could get the guarantee of sale rights.

"This last remark prompted a member of the audience to ask: 'If this company gets the license they ask for, will they monopolize the sale of instruments?'

"Mr. Orchard replied in the negative.

"The chairman explained that the Government had received an application from a company for a provisional license to broadcast till such time as the authorities in Hong Kong learned something of the agreement drawn up between the authorities at Home and the Broadcasting Company. With regard to licenses for receiving sets they had been informed through the Press by Mr. A. G. M. Fletcher that a number of applications of this sort had been received, and were readily granted. Listeners-in would be able to pick up weather reports, trade reports, and messages between ships, etc. At Home every person wishing to get a license of this sort applied at the Post Office, and part of the price they paid went to the Government, and a certain percentage went to the Broadcasting Company, as royalties. As far as he knew the Hong Kong Hotel Company were prepared to broadcast without any such royalties.

"Mr. Orchard confirmed this statement, and moved 'That the Government be urged to expedite the gaining of provisional broadcasting licenses to any Company willing to undertake broadcasting.'

"The motion was seconded and carried.

"Mr. Channy said he took it that after a time the Radio Club would be able to do its own broadcasting, and hold concerts at intervals throughout the week. 'Get the artists to the Clubroom,' he said, 'and broadcast your own stuff.'

"The matter was then dropped, and the meeting came to an end."

# WORKRITE VARIABLE CONDENSER

**\$3.50  
Each**

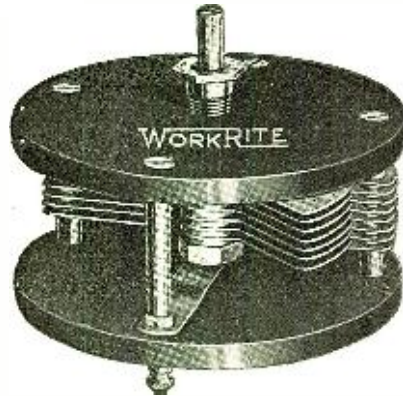

**\$3.50  
Each**

The newest Workrite Radio Product—A Variable Condenser of Workrite Quality. This instrument is accurately made. Each part is held to within .001". The plates are properly spaced. It has .0004 Mfd. capacity. The end plates are made of hard rubber, highly polished. The Workrite Variable Condenser is made to work with the Workrite Neuroformer in the neutrodyne method of receiving. Get one today and be convinced of Workrite Superior Quality.

## Workrite Neuroformer

(Licensed Under Hazeltine Patent No. 1,450,080)

An aircore transformer made to work in the neutrodyne method of receiving. This instrument is most carefully made with just the proper spacing between the Bakelite tubes and the right number of turns of wire. Brass straps for connecting to variable condenser provided. Very efficient.

**Price, \$2.00**

**Workrite Neutralizing Condenser 25c**  
Set of three Workrite Variable Condensers with Neuroformers mounted ..... \$16.50



Send for free Workrite Neutrodyne Hookup.

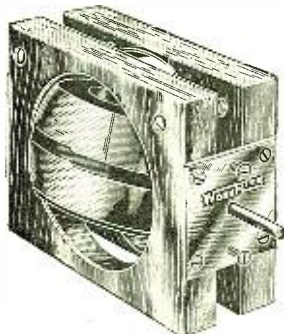

Workrite Super Variometer

**WORKRITE  
TUNER  
TEAM  
\$3.50  
each**

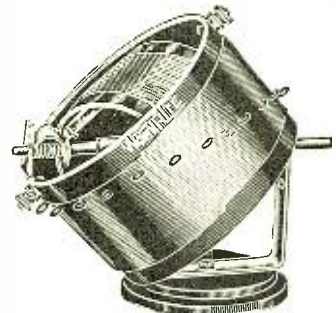

Workrite 180° Super Variocoupler

These instruments are used by many thousands of Radio Fans. The quality is high and the prices low. Get them for your set today.

**"WORKRITE RADIO PARTS WORKRITE"**

**THE WORKRITE MANUFACTURING CO.**

5538 Euclid Avenue

Cleveland, Ohio

(Branch Office, 536 Lake Shore Drive, Chicago)

**FREE  
VACUUM TUBE  
RADIO SET**

Can receive 100 miles and more.

**RUSH** your name how you can get a Vacuum Tube Radio Set **ABSOLUTELY FREE** Don't delay, write today for FREE RADIO PLAN.

**HOME SUPPLY CO.**  
Dept. 16  
131 Duane St., N.Y.C.

**RADIO TUBE  
&  
EXCHANGE**

We Repair All Standard Makes of Tubes including

W. D. 11 or W. D. 12	\$3.50
U. V. 200 or C. 300	\$2.75
U. V. 201 or C. 301	\$3.00
U. V. 201A or C. 301A	\$3.50
U. V. 199 or C. 299	\$3.50
U. V. 202 or C. 302	\$3.50
New 1½ Volt Tubes	\$4.00

All tubes guaranteed to do the work.

**RADIO TUBE EXCHANGE**  
260 BROADWAY NEW YORK CITY, N. Y.  
All Mail Orders Given Prompt Attention  
Orders sent Parcel Post C. O. D.

# Telmaco Radio Guide Book

## Describes the Best in Radio

Our new 64-page Catalog No. TCR contains twenty of the most popular radio circuits printed in blue. These include the Hazeltine Neutrodyne, Grimes Inverted, Colpitts, Flewelling, Reinartz, Diode Electrad, Heterodyne, Super-Regenerative and many others. Each article used in circuit is attractively pictured instead of appearing in straight schematic form. Besides containing blue prints, the best in radio is also illustrated and described. Catalog sent postpaid for Ten Cents. Each circuit worth double. Send for your copy today.

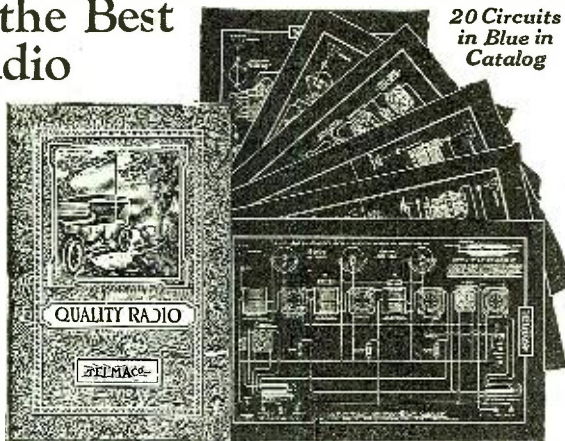

20 Circuits in Blue in Catalog

**DEALERS!** Our New Dealers' Catalog and Price List describes nearly all the better Standard Radio Lines. You should have it. Mailed FREE to all bonafide dealers making request on their business stationery.

**TELMACO**  
Quality Radio Exclusively

Radio Division  
**TELEPHONE MAINTENANCE CO.**  
20 So. Wells St., Dept. B, Chicago, Ill.

## "Since The Dawn

of intelligence the advancement of civilization has been hand in hand with the improvements in methods of communication, until today the world may be considered to be one vast family. This is especially true in relation to the United States and Canada where the art of conveying the human voice from point to point has been developed to a very high degree."

From "The Story of Service"



Your home life and the unity of the family demand that "touch" with the outer world which Radio alone can supply. Satisfaction should be your demand in the purchase of Radio equipment. "SERVICE" Type 212 Radio Receiver will give satisfaction. When you operate the set you instinctively "feel" the great distances over which you may bring desired programmes to your home.

Ask your dealer or write us.

This is a TELEFORCE product

## Service Radio Company

Dept. B

4727 Montgomery Ave.

Cincinnati, O.



Shake, old man; let's get acquainted all over again.

Klosner products are still being made with the same care as previously, using genuine Bakelite throughout. Our Rheostats are designed for all types and tubes.

- 6 Ohm Vernier for WD11-12 \$1.50
- 6 Ohm Non-Vernier .\$.1.20
- 30 Ohm Vernier for 201A and 199 .....\$1.75
- 30 Ohm plain.....\$1.40

Write for free literature.  
"THE FIRST IS STILL THE BEST"



**Klosner Improved Apparatus Co.**  
2024 Boston Road New York City

Rather a long article; at first it may seem uninteresting, but a little time on it will convince one that there is plenty of food for thought. It would be unwise for me to comment, to give my own personal opinion on anything, but fellows, just think it over. Of course no one has to form an opinion—when there is really no cause for controversy, but those who do not can glean from that article a whole lot that we haven't heard about before. English ways and Hong Kong's own ways.

From those two items or articles we see something of radio in the Orient today. I wonder what the casual observer will note of amateur radio 10 years from now in that same country?

## Everyday Observations of the Beat Phenomenon

(Continued from page 535)

will actually be pulsating in agreement with the alternations of the supply current. If the time between successive identical positions of the fan and the time between light pulses almost agree, the result will show what appears to be a slowly revolving fan. It is quite apparent that a four-blade fan will reach a position similar to its original position at the end of one-fourth of a revolution. If the time between light pulses agrees with this time, the fan will appear stationary. If the period between light pulses is not in agreement with the period between successive similar positions, each exposure will show the fan in a slightly advanced or retarded position. The eye receives the impression resulting from a series of such exposures.

### A PRACTICAL APPLICATION OF THE PRINCIPLE

This principle is used in engineering work as the basis of an accurate method for indicating the rotation speed of machines. By attaching to the shaft a cross or spoked figure, and illuminating this by light from a source of known frequency, it is possible to accurately estimate the rotation speed by observing the rotation speed of the slowly revolving image.

A few very simple examples of visible beats are shown in the accompanying figures. Each case is easily analyzed as follows:

Fig. 1 shows two series of black spots, one having, say, four to the inch, the other five to the inch. The result is a periodic registering of spots at the rate of one per inch.

Fig. 2 indicates how two waves combine to produce beats. The figure shows  $12\frac{1}{2}$

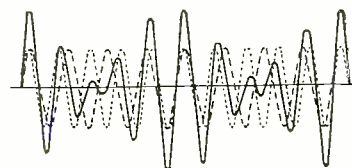
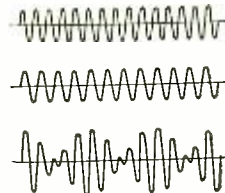

Fig. 2

Illustrating the Combination of Two Electric Waves of Dissimilar Frequency and the Beats Produced Therefrom.

cycles in combination with 10 cycles, the result being two and one-half beats. The dotted line indicates how the two waves are added to obtain the resultant. The wave form in this case is triangular for the sake of simplicity.

Fig. 3 shows the same effect resulting from two picket fences. The difference in spacing of the pickets is due of course to the fact that one fence is nearer the observer than the other.

Figs. 4 and 5 show the same effect resulting from the overlapping of two ordinary window screens. Here the difference in spacing required is due partly to the slight irregularities in the screen construction, and partly to the fact that one screen is nearer the observer than the other.

**POSSIBLE APPLICATIONS OF THE PRINCIPLE**

Without doubt there are many opportunities for the practical application of this principle. There are already several ingenious window display devices which employ this principle. A certain manufacturer of lubricating fluids for automobiles, has a very fascinating exhibit showing a rapidly moving chain passing over sprockets immersed in grease. A non-synchronous shutter is provided by merely placing a perforated disk on the shaft of a small motor. From the observer's point of view the chain appears to be creeping slowly through the liquid. The same effect could have been produced by non-synchronous illumination, and the addition of this feature would be rather baffling to the casual observer at least.

There are great possibilities in scenic effects, multi-color backgrounds, etc., which provide a most interesting field of research for those who possess ingenuity and are inclined to use it.

**State College to Teach Radio by Mail**

(Continued from page 537)

thoroughly into the theory of electricity in order to prepare for a detailed study of electromagnetic waves, radio circuits, and apparatus for reception and transmission.

The purpose of the course is to correct the impression of mystery which surrounds radio and to show that the fundamentals of radio are not as mysterious as is commonly supposed. At the beginning it is assumed that the student has no knowledge of radio and very little of electricity, and the course is developed on that basis. Mathematics has been reduced to a few simple calculations and all technical terms are explained clearly.

"Despite the wide use of apparatus of all degrees of complication, there is still very little known by the average layman of underlying principles of radio," says Professor Miller. "As a result, much apparatus is installed without regard to anything but a blueprint of a hook-up which as often as not does not give the maximum service for the outlay of time and money. In many cases the radio fan connects up apparatus at random, hoping by luck to strike on some scheme that will give him desired results. This is often fatal to valuable tubes and apparatus." Inquiries concerning the course should be sent to the Engineering Extension Department, State College, Pa.

Commander S. C. Hooper, in charge of Radio Engineering in the Navy, it is reported, will become Fleet Radio Officer under Admiral Coontz, when the latter assumes command of the U. S. Fleet.

**New!**  
**Westinghouse**  
**CRYSTAL CASE**  
**"A" Batteries**

- 1 cell—2 volts
- 2 cells—4 volts
- 3 cells—
- 6 volts

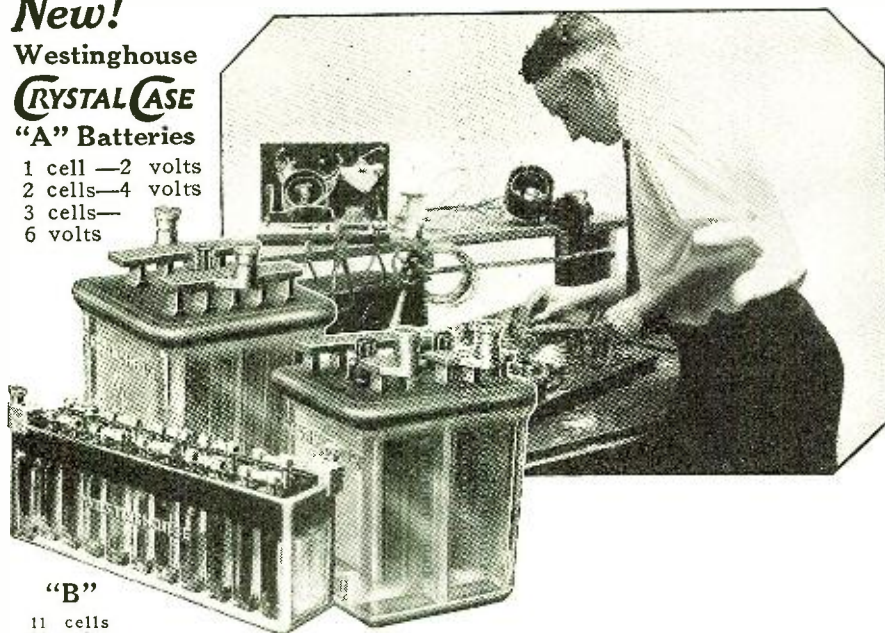

**"B"**

- 11 cells
- 22 volts

**Are You Improving Your Set This Fall?**

NOW that radio broadcast reception has emerged from the early development stage natural with all great inventions; now on the eve of a long winter of radio treats more elaborate and finer than ever, thousands of radio fans are rebuilding or re-equipping their sets with units that have thoroughly proved their worth.

Batteries. You can't be too critical in choosing them. Westinghouse rechargeable storage batteries have won high favor everywhere. Even-powered, full-powered, slow-discharging, they've demonstrated their superiority for fine tuning, signal-holding, sound volume and operating economy. See your dealer and ask for Westinghouse CRYSTAL CASE Batteries. The line is complete—a type and size for every popular radio use.

**WESTINGHOUSE UNION BATTERY CO.**  
Swissvale, Penna.

Westinghouse  
CRYSTAL CASE "A" Batteries

One-piece glass case, with solid glass plate rests. Neat and durable. Visible interior—liquid level readily inspected. Easily recharged.

Westinghouse  
CRYSTAL CASE "B" Batteries.

The 22-MG-2 (22 volts) is a marvel for steady, noiseless, full-powered service. Long-lasting—easily recharged. Larger types, too.



**WESTINGHOUSE**  
**CRYSTAL CASE** "A," "B" and "C"  
**BATTERIES**



**"Read'em"**  
*Copyright*  
**Binding Posts**

**With Knobs That Won't Come Off**

Anyone can "read 'em." All popular styles—Antenna, Ground, Fones, A and B Battery plus and minus—abbreviations of different names engraved on knobs. Radio users—ask your dealer for "Read 'em." Dealers—write Dept. A for liberal profit proposition on this big seller.

The Marshall-Gerlén Co.  
Manufacturers  
Toledo, Ohio

**VACUUM TUBES REPAIRED**

WD11—WD12—UV201A—UV199  
and others for

**\$3.00**

Quick service. All tubes repaired by us guaranteed to work as good as new. Send your dead tubes—we prepay parcel post to you. All you pay is \$3.00 to postman. We give 48 hour service.

**THOMAS BROWN CO.**

511-517 Orange Street Newark, N. J.  
RADIO DEALERS—  
WRITE FOR OUR PROPOSITION

# Reflex Reception Revolutionized

The uniformly satisfactory results obtained by owners of crystal sets have fully demonstrated the superiority in reflex reception of

## M. P. M. Million Point Mineral

Unsolicited testimonials from all over the country show marvelous records up to twelve hundred miles, both with and without amplification.

These crystals will not corrode, burn out or lose their sensitiveness; and clear, musical reproduction is assured. If you are not getting the results you should from your reflex set, ask your dealer for M.P.M. or send us \$.50 for two unmounted, or \$.70 for two mounted; and, in addition to crystals, we will send you diagram of a reflex circuit that we guarantee will give absolute satisfaction.

M. P. M. SALES  
COMPANY  
Dept., N.



247 So. Central Ave.  
Los Angeles  
Calif.

THE WORLD'S GREATEST  
RADIO CRYSTAL

## A Voltage Raiser for C.W. Transmitters

(Continued from page 556)

The brushes make contact with a stationary radial commutator, one type of which is shown in Fig. 2. The design may be modified by using twice as many sectors, thus charging each condenser twice per revolution, and giving a smoother output. In this case, "live" sectors 180° apart are connected together. In a "single cycle" commutator, as shown, there is one live sector in excess of the number of condensers in series. A dead sector is placed in between each live one, making nine, and finally two sectors, each 50 per cent larger than the others, are placed between the two end live sectors. This arrangement of sectors is to prevent short circuiting.

The sectors are formed from a copper ring not less than 1/16" thick, which is cut up as shown in the diagram, and screwed down to a hard rubber panel with countersunk screws. The connections from the condensers are soldered to the screws. As the maximum allowable voltage between the segments of an ordinary commutator is about 30, the usual method of insulation is obviously impossible where the voltage across the gaps may be nearly 500, as a flashover would take place at once. This difficulty is got over by raising the copper sectors from the panel by means of small condenser spacing washers leaving a large surface for metallic dust, etc.

Originally, ordinary contact studs were used instead of copper sectors, for ease in constructing, but it was difficult to prevent either the studs or the brushes wearing rapidly away, and when this took place, sparking became serious, with loss of power.

The connections are as in the wiring diagram, Fig. 3. Small fan type motors can often be obtained second hand at a very low cost, while 2 mfd. condensers are advertised by several dealers. As they do not require to stand more than 230 volts, ordinary condensers are very suitable; some which were tested stood 500 volts without breakdown.

Where a tonic train effect is no disadvantage the size of condensers may be reduced very considerably below that indicated, but for telephony this would be almost as difficult to smooth as rectified A.C.

It may be mentioned that a little oil on the commutator leads to smoother running, and does not seem to impair the electrical contact. Also, before mounting, the whole face of the commutator should be ground down smooth on an emery wheel or cloth. Where it is to be used, the side face of an emery wheel is much less tiring to use.

The actual method of mounting may be left to the constructor, but attention is drawn to the nuts supporting the panel, which allow the pressure of the bushes to be evenly regulated over the surface of the commutator.

Another point to observe is that D.C. mains are earthed either on positive or negative, and hence the output terminals are at an alternating potential with respect to earth, so that care must be taken to prevent any part of the transmitter being earthed except through a condenser capable of standing the full output voltage, and not larger than about .005 μF, or the action of the machine will be interfered with. An ordinary Dubilier condenser is very compact and stands about 1,000 volts. The small ones can pass all the H.F. current most amateurs are likely to be dealing with.

If any trouble is experienced with vibration, even with a carefully arranged balance weight, the noise may be reduced by standing the machine on several layers of thick felt in a cupboard or other shut-in position.

The machine already built, though very roughly put together for experiment's pur-

## Tune Through Local Stations With the Federal DX 58

NO longer is it necessary to wait for nearby broadcasting stations to sign off before you can get D.X. station.

The Federal No. 58 will bring in the distant stations clear and strong, without interference, while local stations are broadcasting.

This feature coupled with the clarity of tone and simplicity of operation make this set the choice of the man who knows.

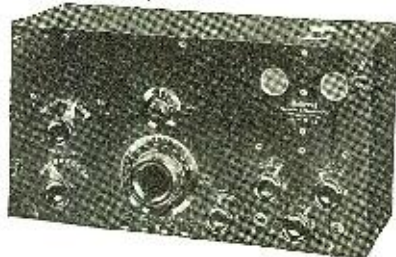

## Federal Radio Equipment

130 Federal Standard Radio Parts offer a complete line of guaranteed Radio units to the man who wants to build his own. Send for the "How to Make" book.

Federal Telephone and Telegraph Company  
BUFFALO, N. Y.

BOSTON NEW YORK PHILADELPHIA CHICAGO SAN FRANCISCO PITTSBURGH  
BRIDGEBURG, CANADA LONDON, ENGLAND

## ONE THOUSAND AGENTS WANTED

WE want one thousand agents to sell subscriptions to RADIO NEWS, SCIENCE AND INVENTION and PRACTICAL ELECTRICS. We will pay a generous commission for this work and help you in every way. Our three publications are leaders in their fields, ready sellers and this is an offer well worth your while. A few spare hours a day will bring you a handsome return. Write regarding our proposition at once and be the first one to get started in your vicinity.

Experimenter Publishing Co.,

HERBERT H. FOSTER, Sales Manager

53 Park Place

New York

*Blairco*

# TRIANON MODEL 2

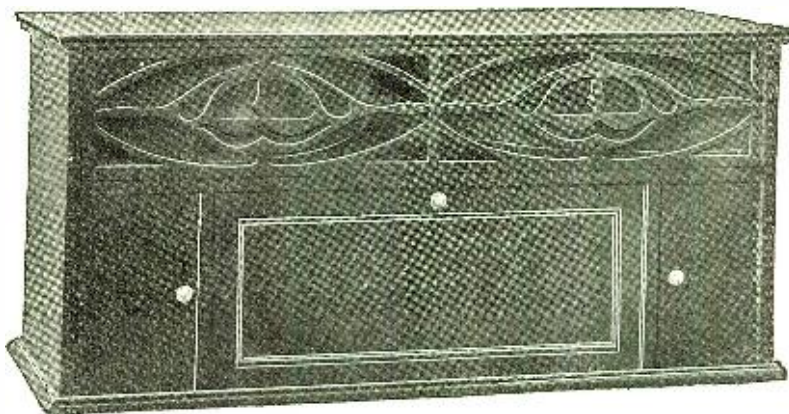

Self contained: all batteries and loud speaker unit in cabinet.

Specially constructed wood horn.

Can be operated on either dry or storage battery equipment.

Mahogany piano finished Queen Ann Cabinet.

Compartment for head phones.

Practically all tuning done with one knob and dial.

235 to 650 Meters

Through many expensive experiments and extensive research work, we have made the Blairco Line as near perfect as human skill and tested materials can make it. The careful purchaser and successful merchandiser of Radio today demands high purchase value, which should include the following qualifications:

- Selective Tuning
- Wide receiving range
- Simple operation
- Undistorted volume
- Low operating cost
- Attractive Design

Not only will the Blairco Line meet the above requirements, but comparative tests have proven Blairco Radio Sets superior to any competitive machine on the market, and they are sold under an absolute guarantee.

Buy Blairco Radio

*Dealer's proposition and descriptive matter on request.*

## MITCHELL BLAIR CO.

New York Office—50 Church St.

Chicago Office—1429 So. Michigan Ave.



# SPECIAL BARGAINS IN RADIO SUPPLIES

### Aetaco Variable Condensers Made with Special Bushing

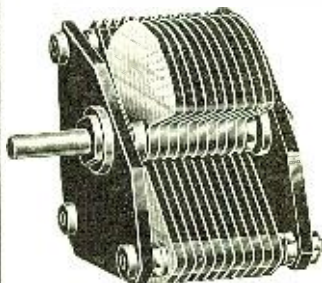

Aluminum Plates, stamped and pressed to insure precision in operation. All spacers are machined brass, nicked finish.

41 Plate ...\$1.75 23 Plate ...\$1.35  
17 Plate ...\$1.25 11 Plate ...\$1.00  
5 Plate ...\$.80 3 Plate ...\$.60

These condensers have xx Formica end pieces, this type end pieces have the least electrical losses due to leakage. Special Proposition to Dealers.

### RHEOSTATS

Reeps Filament Precision Type	\$1.00
K. & C. Vernier	1.25
K. & C. Plain	.90
Michigan Radio, Vernier	1.00
Gen. Radio 2 ohm, 2.5	1.25
Gen. Radio 20 ohm, 2.4	1.75
Federal Plain	.60
Federal Vernier	1.20

### TRANSFORMERS

Acme type A2S A.F.	\$3.90
Federal A.F. 226W.	4.25
Liberty All ratio, A.F.	4.50
All American 10-1 A.F.	3.80
Gen. Radio A.F.	3.75
MuRad R.F.	1.25
Rasla R.F.	4.50
Radio Corporation R.F.	5.00

### POTENTIOMETERS

Paragon	\$1.25
Cutler-Hammer	1.25

### SOCKETS

Ajax Rheo Socket	\$1.25
Standard Socket	.50
Triple Socket	1.50
Triple Fada	2.10
WD11 Socket	.50c. 60c. 65c
UV199 Socket	.60
Adapter	.75

### VARIOMETERS

Emco	\$4.20
Pathé	2.60
Baldwin	3.50
Columbia	2.80

### VARIOCOUPLER

Emco	\$4.25
Baldwin	3.75
WorkRite	2.60
Queens	2.25

### PHONES

Brown	\$12.00
Seibt	8.00
Telefunken	6.40
Kellogg	6.50
Brandes	5.00
Federal	4.25
Gilbert	3.50
Formica Panels cut to order	\$2.00 lb
Formica Tubing cut to order	\$2.00 ft.

All sizes of Mahogany Cabinets.  
Federal Crystal Set complete with Phones .....\$10.00  
Commercial Receiving Set, made by Wireless Imp. Co. 150 to 6000 meters, former price \$225.00.  
Now .....\$55.00  
Magnet Wire, 18 to 30 on 1/4 and 1/2 lb. spools.  
Buss Bar Wire, 2 ft. length 3c. \$13.50 M.

### Back Panel Mounting Inductance Switch



Saves drilling 14 holes. Has 12 contact points. Bushing mounting, with only one hole to drill.  
List Price .....\$75

Indoor Aerial  
Eliminates the trouble of erecting and cost of outdoor or roof aerial.  
List Price .....\$.95  
Special Proposition to Dealers.

Order direct from this ad. or write for our price on any other goods you want  
Postage must be included with all orders

AMERICAN RADIO STORES, 235 Fulton Street, New York

# Tiny Turn

An Entirely New Type of Vernier Control.  
30 to 1 Ratio. PRICE 75c

You can easily tune in stations that you would pass over without the TINY TURN. Can be installed on any set in 3 minutes. Absolutely no lost motion. Turns in same direction as dial.

## DUO-SPIRAL

The Leading Loop Antenna

12 in. size \$7.50. 24 in. size \$8.50

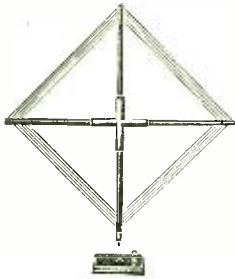

Spans the Continent on a loud speaker. Trim and handsome. Patented construction secures highest efficiency. Wires kept tight by hidden springs. Swivels freely on base. Replaces all outside wires.

Sold through Dealers and Jobbers  
If your dealer cannot supply you, write us.

RADIO UNITS INC.

Room 843 Webster Building, CHICAGO, ILLINOIS

Factory: Maywood, Illinois



PAT. PEND.

# "Cleartone Goldcrest Receivers"

Are Distinctively Different, the Outstanding Features Being:

1. Economical, efficient operation—made possible by reflexing the amplifier tubes thus making one tube do the work of two.
2. Long range reception with unequalled clearness and volume—through the proper combination of radio and audio frequency amplification.
3. Beautiful gold finished panels with lettering in

black and the absence of unsightly, cumbersome control dials, together with the artistic Cleartone solid mahogany cabinets enable our "Goldcrest" models to satisfy the tastes of the most discriminating purchaser.

4. They are fully backed by the Cleartone guarantee which is your protection.
5. The Prices—The best values in the field today.

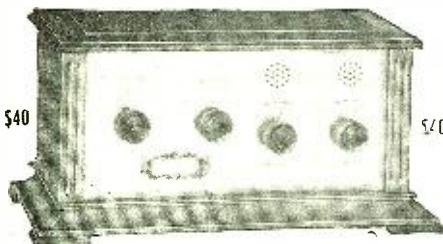

MODEL 20 GOLDCREST

a two tube unit equal to one stage radio-frequency, detector and one stage audio-frequency amplification mounted on gold finished panel with lettering in black, the whole being enclosed in a solid mahogany cabinet.

Model 30 Goldcrest, similar to Model 20 but with an additional stage of audio-frequency amplification..... \$55.00

See Cleartone Radio Products at your Dealers. Literature Free on Request.

THE CLEARSTONE RADIO COMPANY, Inc.

McMILLAN & ESSEX PLACE, CINCINNATI, OHIO

Model 40 Goldcrest, a four tube unit comprising three stages radio-frequency, detector and two stages audio-frequency amplification, for use with LOOP or antenna \$75.00

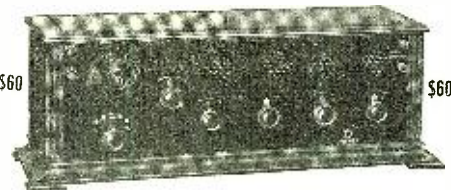

MODEL 40

Our standard four tube radio frequency unit providing for efficient reception over maximum ranges. A set of the highest quality.

The chief advantage of the loop is its poses, is very satisfactory, and delivers about 30 watts at 800 volts.

Intending constructors should have no difficulty in adapting the principle to meet their requirements, at any rate up to 100 watts, and for this reason full details of this particular machine have not been enlarged upon, as it is believed the method of construction is sufficiently obvious to be modified as desired.

[An obvious modification to allow for deriving H.T. from a low voltage battery is to feed the primary of an induction coil with current interrupted by a segmented drum mounted on the same spindle as the condenser distributing contacts. The interrupter drum and condenser distributor can be arranged by means of adjustable brushes so that charges are passed to the condenser when the secondary voltage of the induction coil is at maximum value.—F. H. H.]

—Abstract from our English contemporary, THE WIRELESS WORLD AND RADIO REVIEW.

## Pointers for the New Amateurs

(Continued from page 545)

ability to work through stations lying at or near right angles to the sending station, although even in this particular it is not in actual practice what it appears to be, theoretically.

So far as reducing static is concerned, the regular aerial can be easily arranged to give the same effect as a loop and in addition, the arrangement will allow you to select any graduation from full strength of aerial to below what the smallest loops will give and as the arrangement acts as a wave trap in some respects, the selectivity is increased as the static is diminished.

The arrangement consists of merely connecting an ordinary potentiometer, arranged with an "off" position like an ordinary rheostat, directly across the aerial and ground posts of the set. The primary condenser is operated in the series position; no other change is necessary. The potentiometer may be of either 200 or 300-ohm resistance and when in the "off" position, it has no effect on the set at all. As the resistance is cut in, some advantages in selectivity and ratio of signal strength to static can be obtained, often to excellent advantage.

The aerial and ground are of extreme importance and every effort should be made to secure a good contact with both ground and ether. Remember that most any old set will work for short distances without either aerial or ground and do not be misled by a considerable increase in both signal strength and distance when a ground and a wire are connected. Every effort should be made to secure as perfect a ground contact as possible. Pay no attention to the single-wire fiends, but determine for yourself just what suits you best. There is a practical limit to the length, height and number of wires to use, although the average amateur should have no fear that he will greatly exceed these.

A total length of from 200' to 250' including aerial, lead-in and ground lead is not too much where the minimum wave-length desired does not greatly exceed 150 meters. Two wires spaced not less than 18" apart will give a noticeable increase in signal strength over one wire. Four wires will likewise give a noticeable increase over two wires, provided the spacing is at least 18", while it will take eight wires to give any decidedly noticeable increase over four wires. It will do very little if any good to increase the number of wires on the same

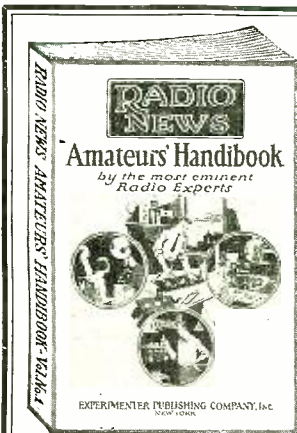

PRICE, \$1.00

JUST THE BOOK YOU WANTED

## "Radio News" Amateurs' Handbook

Volume No. 1

Check full of radio constructive and instructive articles from cover to cover. Written by foremost radio authorities, in plain everyday language which everyone can understand. Sections include articles on Receiving Sets and Sundry Apparatus, Transmitters and Accessories, Radio Theory, Vacuum Tube Data, and Practical Hints for the Amateur. A book which also serves as a ready reference and should find a place in the library of every amateur. It contains 224 pages and over 375 illustrations, diagrams, and photographs, bound in a multi-colored heavy board.

On sale at all leading radio stores. If your dealer cannot supply you, fill a dollar bill to this ad and write your name and address in the margin below, and book will be forwarded to you postpaid.

EXPERIMENTER PUBLISHING CO., INC.

53 PARK PLACE, NEW YORK



# "ALL-AMERICAN"

**Sets another  
World Record!**



The reception on board the Berengaria, night after night, of the signals from the Drake Hotel, Chicago, during the entire voyage, from New York to Cherbourg, France, a distance of 4000 miles, was a world record achievement for consistent reception. The set used employed "All-American" Amplifying Transformers.

Today another record is being made. Slowly winding its way up into the frozen North is the Bowdoin, on board of which is Captain Donald B. McMillan, on a scientific expedition to the North Pole.

Night after night, up in the Arctic Ocean, he is listening to the world thousands of miles south of him. Again "All-American" Amplifying Transformers are being used, and again new world records are being achieved.

You, too, can set new records with your own set by the use of "All-American" Amplifying Transformers.

Ask your dealer to show you these world record-breaking instruments. They are as attractive as they are efficient.

Book of Successful Hookups sent free on receipt of 2c for postage.

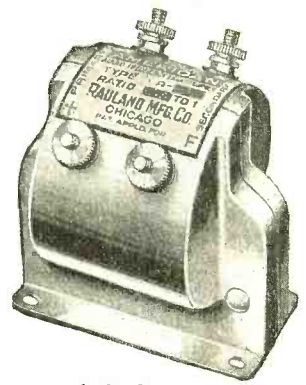

Audio Frequency Transformer

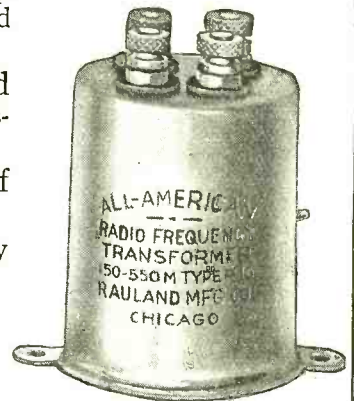

Radio Frequency Transformer



**RAULAND MFG. Co.**  
200 No. Jefferson St., Chicago, Ill.



## Assemble Your Set With DAY-FAN Radio Apparatus And You Will Have—

- |  |   |
|--|---|
| <ol style="list-style-type: none"> <li>1.—Tuned Radio Frequency Amplification.</li> <li>2.—A Balanced Vernier Condenser.</li> <li>3.—Bankwound Bakelite Variocouplers or Variometers.</li> <li>4.—High Ratio—not distorting Audio Transformers.</li> <li>5.—The proper rheostats.</li> </ol> | <ol style="list-style-type: none"> <li>6.—A Receiving Set covering the whole public broadcasting and amateur range.</li> <li>7.—The most up-to-date set in your community.</li> <li>8.—Results you will be proud of.</li> <li>9.—A complete layout to work from.</li> <li>10.—Less money invested.</li> </ol> |
|--|---|

Write for booklet free of charge

**THE DAYTON FAN & MOTOR CO.**

Dayton

Established 1889

Ohio

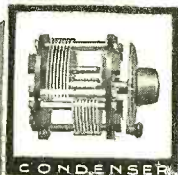

# RADIO FANS

When You Want Quality say  
**"REGAL"**

REGAL INDUCTANCE SWITCH No. 164



The real genuine "REGAL." Beware of cheap imitations. A complete assembly of switch points in one unit. No more drilling holes in panels. No more chipped panels. No more messy soldering back of panels. Mounted on panel with one threaded bushing and nut.

**Complete with handsome knob and dial, \$1.50**

"REGAL" RHEOSTATS are known the world over for their high quality. Smooth positive contact. One thread bushing only for mounting.

Vernier 6 Ohms .....	\$1.25
Vernier 30 Ohms .....	1.25
Regular 6 Ohms .....	1.00
Regular 30 Ohms .....	1.00
Junior 6 Ohms .....	.75
Junior 30 Ohms .....	.75
Potentiometer 200 Ohms .....	1.50

DEALERS — JOBBERS — DISTRIBUTORS  
Ask for our new Catalog No. 18 showing 30 handsome "REGAL" items.

**THE AMERICAN SPECIALTY CO.**  
115-220 HOLLAND AVENUE BRIDGEPORT, CONN.

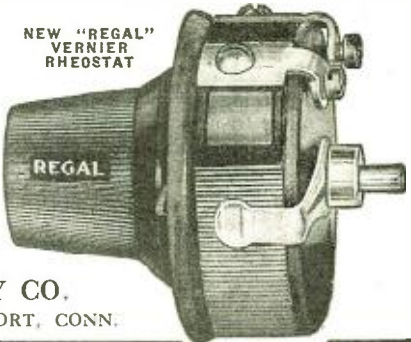

NEW "REGAL" VERNIER RHEOSTAT

spread, but increasing their distance and doubling their number will show a decided increase in both signal strength and distance.

In some localities the height of the aerial is very important, in others very little is gained by going high and sometimes only certain directions are affected by the height. I have known cases where an aerial 60' high would cover distances of from 1,500 to 2,000 miles with fair consistency which, when lowered to a height of 30', would not cover more than 500 miles in a westerly direction, while in other directions the difference in distance and signal strength was very slight. As a rule it is not a paying proposition to erect an aerial more than 60' high, although it behooves every amateur to determine for himself what is needed for his particular locality.

The inverted "L" type of aerial is probably the best and simplest aerial to use for all ordinary amateur purposes of receiving. However, if special tests are to be made in any particular direction, it is recommended that a single or double wire directive aerial be used if there is room. The Beverage wire, as mentioned before, is quite satisfactory when going right, although it requires considerable experimenting to get it right and keep it right. As a substitute it is recommended that no special arrangements be made, but simply string the wire out in the direction desired to receive from. The total length should be at least 600' for reception at 200 meters and the far end should not be over 8' or 10' high. The near end may be anywhere from 10' to 60' high. The higher the near end, the greater the signal strength and the less the directive effect. This aerial should be connected to the set in the regular manner and about 20 or 25 turns of wire (three or four inches in diameter) used on the primary with the primary condenser in the parallel position.

Such an arrangement should give a decided increase in signal strength and distance from stations in the direction of the far end and almost the same in the opposite direction, but signals at right angles to the direction of the wire will be greatly reduced over those received on a regular aerial. The height of the near end can be regulated to give the best ratio of signal strength in the desired direction to those at right angles to it; 20' to 30' for the near end will be a fair height. If such an aerial is used for special short period tests, No. 14 aluminum wire is recommended as it is cheap and light and for stretches of from 600' to 800' will require no intermediate supports. If more conductivity is desired, two of these wires spaced about one foot apart and connected together at both ends are recommended.

In conclusion, it is suggested that all tests for maximum distance and maximum signal strength of distant stations be conducted as near the middle of the day as possible, and this range, say from 10 A.M. to 2 P.M., should be considered the standard range of your particular apparatus. At this time of day signals, interference and fading will be at a minimum and the least change in the signal strength of a distant station or the appearance of a new station can be detected. Also any changes in signal strength or distance will as a rule be very gradual for these hours varying only slightly and gradually through the different seasons of the year, while signals in the early morning, late afternoon and night will be very unreliable and vary greatly from day to day or from hour to hour, thereby making accurate tests almost impossible. Moreover, once the mid-day range of your station is definitely improved you can rest assured the night range will take care of itself. While it is never a good policy to give any definite range for any instrument, as too

# A BEAUTIFUL TABLE



We are manufacturers of fine furniture and we sell Radio Furniture direct to you at only a small factory profit.

**SPECIFICATIONS**

Hardwood, hand-rubbed mahogany or golden oak finish. Height, 31 inches. Size of top, 20 x 34 inches. Drawer, with lock, size 4 x 10 x 13 3/4 inches. Battery Cabinet, size, 17 x 14 x 16 inches.

**PRICES**

Freight Paid East of Miss. River.... \$18.00  
Freight Paid to Rocky Mt. States.... 20.00

**CASH WITH ORDER**

Send for free catalogue of Radio Furniture. Reduced prices on all Cabinets.

**THE SOUTHERN TOY CO.,**  
HICKORY, N. C.

## TWO SUPERSENSITIVE CIRCUITS

(Both Copyrighted)

My Highly Improved Reinartz brings in all important stations on both coasts and Mexican border, loud, clear and without distortion. We dance to music from Atlanta received on one loud Baldwin unit. Build one of these wonderful sets from my blueprints and specifications, price 50c. or with a perfect and complete double wound spiderweb coil, \$3.00 by mail. No other windings used. Photo of my set on a glass panel with every order.

This copyrighted circuit is the most successful of any Reinartz modification yet produced, and is imitated the most. Thousands are in use.

My W. D. II Circuit is especially designed for use with the "Picklo" tube and brings out the full value of that little tube as no other circuit can. Stations 1000 miles away come in clearly on one tube. This set is small, complete, portable. For the man who wishes the highest efficiency, this is the set to build. Price of blueprint and specifications, 50c. or with complete and perfect windings, \$3.00. Photo of set with every order.

Sets built from these plans will receive all broadcasting stations operating under the new laws. Their wavelength range is from 170 to 800 meters.

### AUXILIARY TUNER

This new instrument connected to your present receiving set with one wire enables you to easily bring in both the long and short wave stations which you cannot get with your present equipment. It also enables you to eliminate that local interference so you may listen to distant stations.

Copyrighted diagram and complete instructions for building and operating this instrument, 50c. or with all parts, including Condenser, Coils, Switches, and Panel, \$3.50. Complete instrument, \$15. All goods prepaid. These instruments are easy to build, easy to operate. Everything clearly shown.

**S. A. TWITCHELL**  
1927 Western Avenue Minneapolis, Minn.

## Radio Supplies AT CUT PRICES

Baldwin Headsets (Type C) .....	\$ 8.75
Federal or Brandes Phones.....	4.95
Murdock Headsets .....	3.50
Western Electric Peanut "N" Tubes....	5.95
Magnavox (New Type Goldseal) .....	29.95
Acme Radio or Audio Transformers....	3.95
Ames Audio Transformers .....	2.95
22 1/2 Volt Variable B. Battery .....	.90
22 1/2 Volt Variable B. Battery .....	1.75
45 Volt Variable B. Battery .....	2.50
22 1/2 Volt Eveready Variable B. Battery	1.25
22 1/2 Volt Eveready Variable B. Battery	2.25
45 Volt Eveready Variable B. Battery ...	3.95
43 Plate Variable Condenser with Vernier	3.95
23 Plate Variable Condenser with Vernier	3.50
11 Plate Variable Condenser with Vernier	3.25
180° Fischer Bakelite Variocouplers....	2.50

ALL ORDERS MUST INCLUDE POSTAGE

**KENSINGTON RADIO SUPPLY CO.**  
4417 18th Avenue Brooklyn, N. Y.

much depends upon the skill of the operator, design and construction of set, aerial and ground not to mention atmospheric or local conditions, to give the younger amateurs some idea as to what they should expect I will say that a good regenerative set plus one stage of audio frequency amplification should be made to cover a mid-day distance of between 300 and 400 miles with fair regularity during the winter months and between about 250 and 300 miles during the summer months, when receiving from amateur transmitters using between 10 and 50 watts.

**Eliminating Static With the Resonance Wave Coil**

(Continued from page 523)

These observations apply to effects produced by radio-frequency alternating currents in the system.

Atmospheric disturbances are assumed to travel in trains of extremely low frequencies—between 200 and 300 cycles a second. On the basis of this assumption, what is the effect of the crashing noises

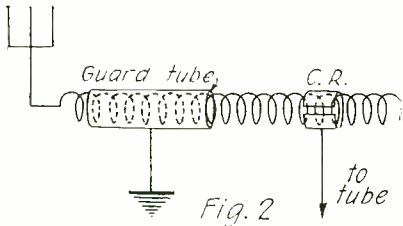

Fig. 2

The Position of the Metallic Rings on the Coil.

**"It Speaks for Itself"**



**Little Senior (Complete with 6 feet of cord) \$19.50**

TRUTONE LITTLE SENIOR is a complete Loud Speaker that is a marvel for its price. The large diaphragm contained in the perfectly cured wooden tone chamber in the base reproduces soft, true, clear and resonant tones. The beautiful crystalline composition horn makes the TRUTONE attractive to the eye and keeps its reproduction free from any metallic noises. The horn with 10 inch bell stands 24 inches high.

**TRUTONE SENIOR (Complete with 6 feet of cord) \$25.00**

The SENIOR is supreme for all long distance work as its extra large tone chamber with diaphragm built-in gives volume to the most distant sound. It stands 32 inches high with the bell of the horn measuring 14 inches.

**TYPE "A" AND "B" AMPLIFYING HORNS.....\$8.00 each**

TRUTONE AMPLIFYING HORNS are constructed for use with any make of head receivers. Reproducing the tones meant for car contact so that the entire family may enjoy the receiving set. Type "A" is designed for use with double receivers and Type "B" for single receivers.

**If You Can't Buy A TRUTONE From Your Local Dealer**

Mail draft or Money Order direct to us and the model you desire will be sent to you postage prepaid.

All TRUTONES absolutely guaranteed

**SADLER MANUFACTURING CO.**  
86 FOURTH STREET SAN FRANCISCO, CAL.

SADLER MFG. CO.,  
86 Fourth Street, San Francisco, Calif.  
Enclosed please find Money Order for \$.....  
which send me.....  
Postage paid.....  
Name.....  
Address.....  
P.O. State.....  
RN

**Equip Your Christmas Radio Set with the Original BALDWIN Receiver**

Only the original BALDWIN radio phone is manufactured under the personal supervision of the inventor and sold with the absolute guarantee of satisfaction after a fair trial, or your purchase price refunded, including transportation charges.



**LOOK FOR THIS LABEL ON THE BOX**

The BALDWIN is superior to all others because of its distinct construction—light weight, supersensitive mica diaphragm, permanently responsive; circular magnet with two U-shaped pole pieces, giving four points of magnetic contact; built like a fine watch. It gives perfect radio reception.

Ask your dealer for the original BALDWIN. If he cannot supply you write for circulars and price lists.

**NATHANIEL BALDWIN, INC.**

3474 South 23rd East Street

Salt Lake City, Utah

Attractive proposition open to distributors and dealers.



### BROCKWAY VARIABLE CONDENSER

*THE BROCKWAY* Combines advantages not found in any other condenser.

**EASIER TO ADJUST** Two complete revolutions of the dial or 720 degrees are used for adjustment. A white line on edge of dial appears during the second revolution, plainly indicating position.

**SAVES SPACE** Occupies no space behind the panel, leaving room for tubes, B. batteries, etc. Ideal for portable construction.

**PLEASING APPEARANCE** Its symmetrical design and beautiful finish harmonize with other high grade instruments, and lends dignity to the finest set.

**HIGHLY EFFICIENT** The use of mica dielectric between two spring bronze plates, scientifically formed to properly control the capacity curve, is responsible for its higher efficiency. Stations are more easily picked up, and we are receiving many reports of new long distance receptions. The Brockway Variable Condenser will improve any circuit requiring from 11 to 45 plate condenser.

**Price \$3.50**

**BROCKWAY LABORATORIES COMPANY**  
Toledo Factories Building TOLEDO, OHIO

### This "UNITED" Audio Frequency Amplifying Transformer

is a little "gem" of radio engineering—magnetically shielded, Ratio 5 to 1—a wonder-worker in producing loud, clear-toned signals, from any distance. At your dealer's \$4.50.



"United" Variable Condensers have a new vernier dial assembly, original with us, that makes fine tuning a joy.



43 plate .....	\$6.50	5 plate .....	\$5.00
23 plate .....	6.00	3 plate .....	4.75
11 plate .....	5.50	Postpaid.	

**PRICE WITHOUT VERNIER**

43 plate .....	\$4.00	5 plate .....	\$2.50
23 plate .....	3.50	3 plate .....	2.25
11 plate .....	3.00		

Show this ad to your dealer and ask him to supply your needs at the above prices. If he cannot do so, remit to us direct, under our money-back guarantee and give us name and address of dealer you wish to favor.

**UNITED MFG. & DISTRIBUTING CO.**

9705 COTTAGE GROVE AVENUE,

New York Office: 50 Church St., New York, N. Y.      CHICAGO, ILL.      San Francisco Office: 709 Mission St., San Francisco, Cal.

of "static" on the resonance wave coil? When this noisy, abrupt impulse invades the antenna, a high voltage circulates on the left end of the resonance wave coil. The electric load is imposed abruptly. This voltage then proceeds to travel along the coil, the latter absorbing the impulses, as it were. If this tendency is not interrupted, the resonance wave coil will oscillate at its own frequency. Fortunately, however, the "guard tube," described in a preceding paragraph, conveys a large share of the "static" impulses to the ground, thus avoiding the oscillation of the resonance wave coil.

When a person desires to render a harsh criticism or maybe expert judgment concerning any so-called "static eliminator," he will exclaim, "Oh yes, it kills 'static' and the signals, too." This occurs in the arrangement of the resonance wave coil in its suppression of atmospheric disturbances at this stage, but thanks to the ingenuity of Doctor Cohen and his co-laborers, there is a resourceful addition to this arrangement which reserves the orderly radio signals for reception by means of the head telephones. Happily, it is called the "rejector circuit"; obviously, because it rejects the useless noises and conserves the useful signals. This is accomplished by "grounding" the "guard tube" in such a manner that the connection functions as a "solid ground" on all wave-lengths except one.

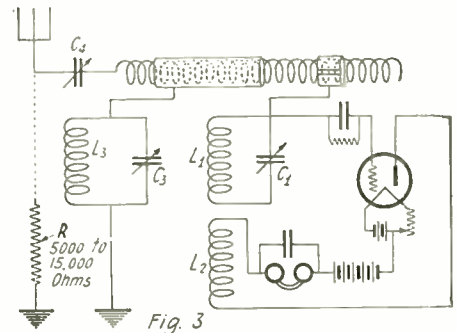

The Connections of the Guard Tube Used to Eliminate Static. The Trap Circuit Should Be Tuned to the Incoming Signal.

Suppose the electric circuit of the resonance wave coil is adjusted to a wave-length of 300 meters, all other electric waves are conveyed to the ground. The 300-meter wave-length is rejected, or arrested, more properly speaking, and the signals are transferred to the "collector ring". The "rejector circuit" not only drains the atmospheric disturbances to the earth, but likewise conveys signals of frequencies other than one particular wave-length to the ground. The latter action should prove useful in eliminating some of the interference now caused by the multitude of broadcasting stations—approximately 500, all told—that are releasing their burdens of song and story upon a heavily charged ether.

The "rejector circuit" stipulated by the Signal Corps is one possessing low electrical resistance, which necessitates the use of heavy wire in the construction of the resonance wave coil and a variable condenser of unquestioned quality, with small losses. Such a variable condenser may, suitably, be of .001 microfarad capacity, shunted across a coil having 55 turns of D. C. C. wire. The latter, according to a suggestion of the Signal Corps, may be of No. 14 B. & S. gauge, threaded around a tube 3/4" in diameter. This arrangement will afford an inductance of 0.1 of a millihenry. Preferably, this variable condenser should be insulated with hard rubber.

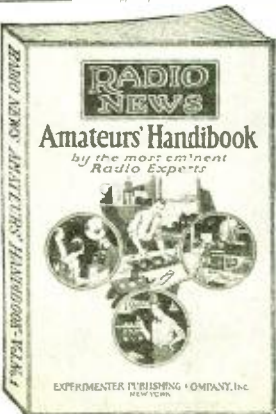

JUST THE BOOK YOU WANTED

### "Radio News" Amateurs' Handbook Volume No. 1

Check full of radio constructive and instructive articles from cover to cover. Written by foremost radio authorities, in plain everyday language which everyone can understand. Sections include Articles on Receiving Sets and Sundry Apparatus, Transmitters and Accessories, Radio Theory, Vacuum Tube Data, and Practical Hints for the Amateur. A book which also serves as a ready reference and should find a place in the library of every amateur. It contains 224 pages and over 375 illustrations, diagrams, and photographs, bound in a multi-colored heavy board.

On sale at all leading radio stores. If your dealer cannot supply you, pin a dollar bill to this ad and write your name and address in the margin below, and book will be forwarded to you postpaid.

**EXPERIMENTER PUBLISHING CO., INC.**  
53 PARK PLACE, NEW YORK

PRICE, \$1.00

Structurally, the "collector ring" and "guard tube" entering into the formation of this "static-eliminating" device, are made of brass and in finished forms should fit snugly. By way of suggestion, the winding may be covered with a layer of thin paper and then tubes employed that will slide smoothly over the paper. It is optional with the constructor whether the "guard tube" is split or not, but the "collector ring" necessarily contains a split.

A tickler or plate-circuit variometer is employed if regeneration is desired in this particular electric circuit. Use

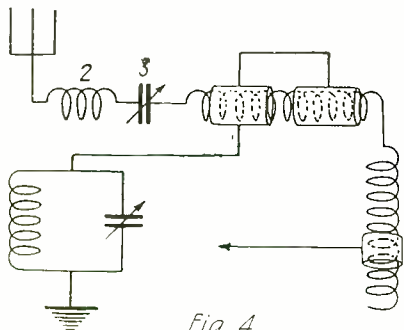

Fig. 4

Better Elimination of Static is Obtained by the Use of Two Coils and a Guard Tube Composed of Two Sections.

of either of these instruments in this connection demands a tuned secondary circuit connected to the grid element of the vacuum tube. Regeneration is also possible by means of the resonance wave coil in the absence of additional windings of wire.

In this capacity of reducing seasonal atmospheric disturbances, both the resonance wave coil and the radio-receiving instruments must be screened, in the event that violent crashing and rumbling noises are to be suppressed. Complete screening is absolutely essential, which requirement indicates that the entire outfit must be enclosed in an air-tight copper case of reasonable thickness, 18 gauge, for instance. The batteries or wiring to and from the latter to the radio instruments must not be exposed. The telephone cord should be protected by a strip of copper Belden braid, which is "grounded" to the copper shield.

The resonance wave coil lends itself to use with a variety of electric circuits in the capacity of "static eliminator". It may be employed with a single-circuit, now commonly found in homes of broadcast listeners, or with an inductively coupled tuner. The latter arrangement is likely to result in extreme sharpness of tuning. Likewise, the resonance wave coil is adaptable to use with a tuned antenna system, which arrangement, however, is conducive to extreme selectivity. In this instance, a switch is provided so that the coil may be connected above the tuned primary circuit when receiving weak signals, or below (at the ground

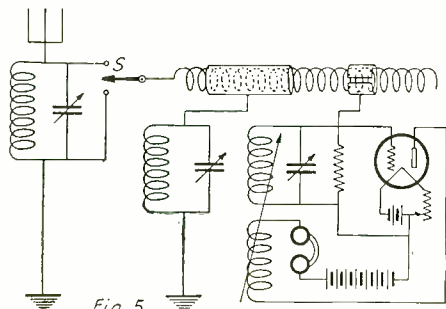

Fig. 5

A Resonance Wave Coil May Be Used With a Tuned Aerial Circuit, and Provides Extreme Selectivity.

# Announcement

## Genuine PACENT \*Duo Lateral Coils Mounted

\*REG. U. S.  
PAT. OFF.

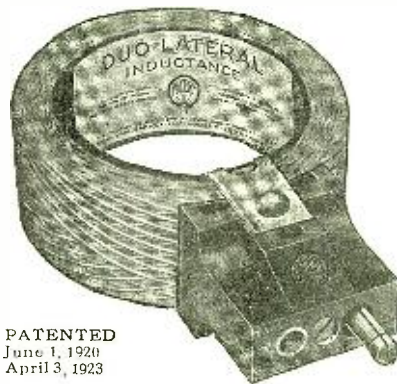

*A Complete Line  
of Improved Coil  
Equipment, In-  
corporating Many  
Superior Features.*

PATENTED  
June 1, 1920  
April 3, 1923

- I. PACENT COIL PLUG—Quick to connect. Vise grip on coil. Set screw with coil lead connections. Cat. No. 110. Price \$1.00.
- II. COIL PLUG RECEPTACLE—an improved receptacle. Special Pacent feature to insure tight contact. Cat. No. 111. Price \$1.00.
- III. MOUNTED COILS—The genuine Pacent Duo Lateral Coils equipped with improved plug. Sizes MS 25 to MS 1500. The perfect combination. Prices \$1.40 to \$3.85.
- IV. MICROMOUNT—a de luxe 3 coil mounting affording fine vernier coupling adjustment. Cat. No. 115, with base, \$9.50. Cat. No. 115A, same as No. 115 less base and binding posts, \$8.00.
- V. MICROCOUPLE RECEPTACLE—a single receptacle permitting vernier adjustment of coil. Cat. No. 118. Price \$2.00.
- VI. PANEL RECEPTACLE—a fixed receptacle for panel mounting principally for use with Cat. No. 118. Cat. No. 119. Price \$1.50.

All Pacent Coil equipment is standard size and connects with standard equipment of other manufacture.

Duo Lateral Coil labeled PACENT is the GENUINE

THE Genuine Duo Lateral Coil, PACENT, has been recognized by authorities as the most efficient inductance.

Careful and thorough study of coil equipment requirements has resulted in the development of these new Pacent Products, the last word in mounted coil equipment.

Don't Improvise — "PACENTIZE"

Send for Booklet N-11 describing in detail these new Pacent Radio Essentials.

PACENT ELECTRIC CO., Inc.  
22 Park Place New York, N. Y.

Sales Offices:  
Chicago, Philadelphia, St. Louis, Minneapolis,  
Washington, D. C. San Francisco, Jacksonville.

# Pacent

## RADIO ESSENTIALS

### You Don't Need Tubes

to get out of town. Even in summer we receive concerts over 400 miles with my CRYSTAL HOOK-UP. Over 1000 miles in winter. Thousands have bought my plans and remodeled their sets or built sets like mine. Satisfaction GUARANTEED. Send self addressed envelope for further information.  
Leon Lambert,  
595 South Volusia, Wichita, Kansas.

### WORKING KNOWLEDGE Of Radio Code and License

In One Week. Best Record Licensed Students: Code Mastered 15 Minutes; Ten word Speed in 3 Hours. 40 Records FREE or Honor Roll 100 Licensed Students One Dime. Complete Method only \$2.00. Dodge Radio Shortcut, Dept. N, Mamaroneck, N. Y.

Operate your radio from your lamp socket with a

### Gould Unipower Battery

For complete information address  
GOULD STORAGE BATTERY CO.,  
30 East 42nd Street New York

Parts and Accessories for makers of radio apparatus

**GERACO**  
PROVED RADIO PRODUCTS

Details and Prices on request  
GENERAL RADIO CORPORATION  
Mrs. E. Distributors of  
First Quality Radio Equipment  
including MUSIC MASTER RADIO Reproducer  
16th and Cherry Streets Philadelphia

WANTED—Back numbers of Radio News, Dec., 1921, Jan. and Feb., 1922. Experimenter Publishing Co., 53 Park Place, New York City.

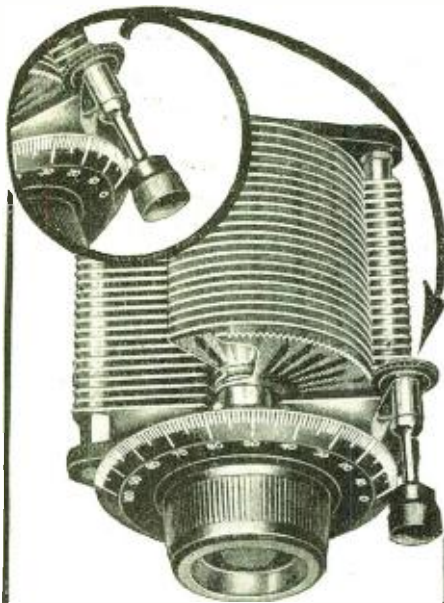

## HEATH'S Radiant Condensers

Now the "guess" has been taken out of condenser buying. The source of greatest uncertainty, the plates, by a new process of stamping and tempering in *Heath's Radiant Condensers* are PERMANENTLY FLAT. They are as proof against warping and buckling as a steel straight edge. These condensers will keep their fine alignment without any adjusting during their *entire life!*

### A Vernier Adjustment Geared Like a Watch

Ordinary vernier adjustment reduced to micrometer fineness. Extreme delicacy of adjustment. Smooth, positive, accurate as a watch. *Heath's Radiant Condensers* are especially adaptable to the fine tuning required on high amplification.

Write for Illustrated Folder

#### LIST PRICES. VERNIER TYPE

13 Plate including 2 3/4" dial and knob.....\$5.00  
25 Plate including 2 3/4" dial and knob.....\$5.50  
45 Plate including 2 3/4" dial and knob.....\$6.50

Jobbers and Dealers

Write Immediately for Proposition

## HEATH RADIO & Elec. Mfg. Co.

206 First Street  
NEWARK, N. J.

### Improve your set by using the Welsh Peanut Tube

Strong, velvet tone, no distortion, low initial cost; economical to operate, uses about 1/4 amp. Can be operated on storage battery or THREE DRY CELLS. Filament 4 to 6 v. Plate 1 1/2" to 32 v.



Price \$2.00

Special Sockets .....40c.  
Adapters .....75c.

At your dealer, otherwise send purchase price and dealer's name, and you will be supplied postpaid.

JOBBERS and DEALERS  
Write for our special proposition.

Manufactured only by the  
**Welsh Electric Lamp Corp.**  
72 BOYLAN STREET NEWARK, N. J.  
Beware of Imitations

connection) when listening to robust signals through interference.

Experiments conducted by the Signal Corps over a period of three years indicate that greater suppression of atmospheric disturbances may, occasionally, be obtained in the absence of critical adjustments by separating the "guard tube" in two parts, and including a second resonance wave coil for holding the "collector ring." The second resonance wave coil, in winding, is a duplicate of the first one. Such a circuit permits the use of radio-receiving apparatus of practically any design.

The performance tests of this new device, or rather applications of an instrument invented several years ago, indicate the possibility of receiving long-distance radio communications that would otherwise be inaudible because of the prevalence of atmospheric disturbances. Signals from the high-power radio telegraph stations of the United States Navy Department located on the Pacific Coast have been heard in the laboratory of the Signal Corps at Washington, by the use of the resonance wave coil, when the distracting extraneous noises would have almost jarred the head telephones from the ears of the operator under usual conditions of reception.

Resonance wave coils, in their multiple variations of size and windings of wire, lend themselves to a diversity of uses. One type of coil constitutes a full-fledged wireless antenna, dispensing with any radio-receiving instruments other than a detector and a pair of head telephones. No ground connection, either counterpoise or actual, is required. As a single-unit radio direction finder another design of resonance wave coil is able to determine the position and altitude of aircraft in flight. Still another type of resonance wave coil enables the laboratory of the Signal Corps in Washington, when using six stages of radio amplification, to receive signals from a radio telegraph station of the United States Navy Department located at Guantanamo, Cuba.

The application of resonance wave coils in the reduction of atmospheric disturbances, however, offers the most fascinating field of experimentation for the radio amateurs. The development of these coils by the Signal Corps while in the pursuit of methods and apparatus for communication purposes necessary to the prosecution of war, is an example of how war-created difficulties are responsible for an invention of far-reaching significance to peaceful industries. If resonance wave coils can lift the bane of radio telegraphy and telephony it will have earned the everlasting gratitude of the radio industry. These coils certainly merit further experimentation as a possible means of removing, or partially subduing, the clicking, crashing and hissing noises that invade the radio-receiving instruments for five or six months of a twelve-month period.

### I Want to Know

(Continued from page 566)

This produces a relatively weak first half cycle. However, when the primary circuit is open, the self-inductance of the primary does not figure, and the magnetic field collapses much more quickly than it built up, so that the voltage induced in the last half cycle is considerably larger than the first.

#### QUESTIONS ON THE SUPER- HETERODYNE

(795) Mr. N. T. Engelhardt, Jr., Riverdale, N. Y., writes:  
Q. 1. May the Super-Heterodyne receiver, pub-

It Costs You No More  
to Buy

## Columbia Bakelite Moulded Apparatus

### The All-Circuit Variometer

The Columbia Variometer is fully bakelite moulded, green silk, pigtailed, and provides for all circuits of today and tomorrow; the stators may be split. You cannot obtain a finer tuning variometer. Body capacity minimized. Regenerative, Ultra-Audion, Flewelling, Reinartz and Reflex Circuits all provided for. Diagrams with each instrument.

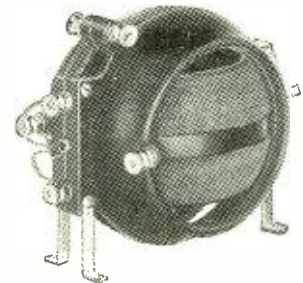

Type 109, Price . . . \$5.50



The Geared Coil Mounting you have been looking for. Moulded of genuine bakelite; geared 5 to 1 reduction; 6 inch silk leads. A True Columbia Product.

Type 401, Price . . . \$5.00

A few more Columbia Products:  
Bakelite Moulded Variocoupler Type 105a.....\$5.00  
Bakelite 180° Variocoupler Type 105..... 5.00  
Bakelite 3 coil Geared Mounting Type 401... 5.00  
Bakelite 2 coil Geared Mounting Type 402... 3.50  
Inside Coil Mount Geared and "Vernier"  
Type 403 ..... 7.00  
Coil Plugs ..... .50  
All Meter 180° Couplers ..... 7.00  
and complete line of mounted coils.

All good dealers have Columbia Products.  
Insist on them.

## Columbia Radio Corp.

155 N. Union St., Chicago

## FREE



### RADIO SET WITH DOUBLE HEAD PHONES

This wonder RADIO SET in special metal cabinet with double head phones complete ready to hook up  
**ABSOLUTELY FREE**

LISTEN in on concerts, sports, lectures, singing, etc.  
**QUICK!** Send only your name to-day for wonderful FREE RADIO PLAN.  
**GUARANTEE SALES CO.**  
26 Washington Place Dept. 116 New York

**KILLOCH HEAD SET**  
2000 OHM \$3.25 POSTPAID IN U. S. A.  
Baldwin Head Set \$8.75 Postpaid in U. S. A.  
Send For Radio Catalogue  
DAVID KILLOCH CO., 57 Murray St., N. Y. City

lished in the September issue, question No. 711, be used for phone reception between 195 and 600 meters?

A. 1. This receiver will respond to any wave-length to which the tuner can be tuned. If a vario-coupler is used with a .001 mfd. condenser across the secondary this range of wave-lengths will be covered.

Q. 2. Should the honey-comb coils shown in this circuit be fixed or variable?

A. 2. These coils, when once adjusted, will not have to be moved and may be fixed.

## Audio Frequency Transformers

(Continued from page 559)

are mounted. Many transformers are protected by a metal shield which entirely covers the coils. This is good practice as far as protecting the coils from mechanical injury is concerned, but electrically, no advantage is gained.

Now that a general idea of the elements of the transformer has been obtained, we will discuss ratio, which is a very important consideration in amplifying transformer design. Ratio is simply the proportion of the number of turns of wire in the secondary coil to the number of turns in the primary coil. Transformers now on the market vary in ratio from 3:1 to 10:1. In other words, the secondaries have from 3 to 10 times as many turns as the primaries. In a 10:1 ratio transformer, if 1 volt is applied to the primary, the secondary will deliver about 10 volts, and in a 3:1 ratio transformer the secondary will deliver about 3 volts; hence, as the vacuum tube is a potential operated device, there is a tendency on the part of the layman to choose a high ratio transformer, thinking he will get greater amplification. He is correct in regard to greater amplification, but if he considered the distortion introduced by the high ratio instruments now available, he would select a low ratio one. None of the high ratio transformers which were tested by the writer were as efficient in regard to distortion as the lower ratio ones. If the transformer is to be used for amplifying dot and dash code messages, where distortion makes no difference, a high ratio one is preferable, but for broadcast reception the low ratio ones are by far the better. It should be remembered that these transformers do not amplify the energy; the voltage is amplified and the current reduced, and, neglecting losses in transformation, the energy is constant. It is the vacuum tube that amplifies the energy in an audio frequency amplifier.

We will now consider the method used in testing the transformers. In Fig. 5 is shown a diagram of the testing apparatus, called a "peak volt meter." The audio frequency oscillator is a vacuum tube affair, capable of delivering alternating currents of from 100 to 6000 cycles per second. The transformer under test is connected as shown, but the test leads, which are shown connected to the secondary of the transformer, are first connected to each other, and the slider on the potentiometer P adjusted until the plate current indicated by the milliammeter is zero. The reading of the voltmeter is then noted and the potentiometer slider is then readjusted until the voltmeter reading is increased by two volts. The test leads are then connected to the primary of the transformer and the oscillator set into operation at any desired frequency. The variable resistance R1 is then adjusted until the plate current is again zero. Then the peak voltage applied to the primary is 2. The test leads are then connected to the secondary, as shown, and the potentiometer adjusted until the plate current is again zero. The voltmeter reading is observed, and from its value the value first noted with the test leads connected together is subtracted. The difference is the peak voltage across the secondary ter-

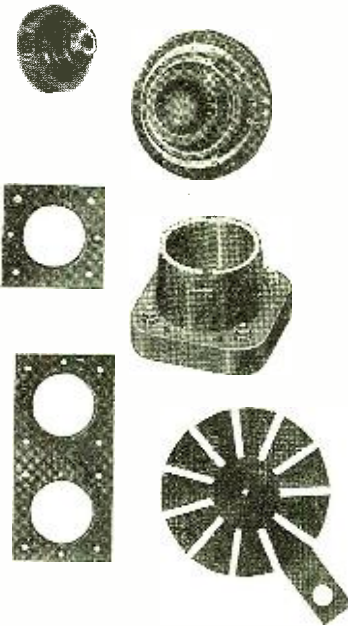
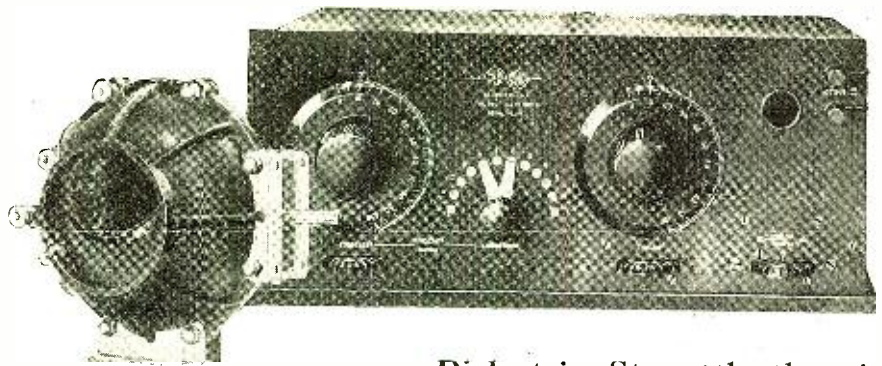

**BAKELITE**  
**Condensite**  
**REDMANOL**

are the registered  
 Trade Marks for the  
**Phenol Resin**  
 Products  
 manufactured under  
 patents owned by  
**BAKELITE CORPORATION**

**Dielectric Strength that is Constant under varying climatic temperatures is the property of phenol resin insulation.**

Electrical insulating materials having a mineral base, glass, porcelain, and phenol resin for example, possess dielectric strength that does not diminish with age or use.

Just as the electrical conductivity of copper is constant, so is the insulating strength of the phenol resin. Radio parts and panels sold under the trade-mark **Bakelite—Condensite—Redmanol.**

Combined with this dielectric strength are the additional advantages of mechanical strength, freedom from moisture absorption, lasting beauty of finish and color.

The leading manufacturers of radio parts and panels have adopted phenol resin insulating materials because they give uniformly satisfactory service under practically all working conditions.

### BAKELITE CORPORATION

Address the Divisions

General Bakelite Company, 8 West 40th Street, New York  
 Condensite Company of America, Bloomfield, New Jersey  
 Redmanol Chemical Products Co., 636 West 22d St., Chicago

3235-B

## THE MATERIAL OF A THOUSAND USES

**RADIO NEWS**  
**Amateurs' Handbook**  
*by the most eminent Radio Experts*

EXPERIMENTER PUBLISHING COMPANY, INC.  
 NEW YORK

**PRICE, \$1.00**

JUST THE BOOK YOU WANTED

## "Radio News" Amateurs' Handbook

Volume No. 1

Check full of radio constructive and instructive articles from cover to cover. Written by foremost radio authorities, in plain everyday language which everyone can understand. Sections include articles on Receiving Sets and Sundry Apparatus, Transmitters and Accessories, Radio Theory, Vacuum Tube Data, and Practical Hints for the Amateur. A book which also serves as a ready reference and should find a place in the library of every amateur. It contains 224 pages and over 375 illustrations, diagrams, and photographs, bound in a multi-colored heavy board.

On sale at all leading radio stores. If your dealer cannot supply you, pin a dollar bill to this ad and write your name and address in the margin below, and book will be forwarded to you postpaid.

**EXPERIMENTER PUBLISHING Co., Inc.**  
 53 PARK PLACE, NEW YORK

# 562 page RADIO BOOK only

Compiled by  
**HARRY F. DART, B.S.E.E.**  
Formerly with the  
Western Electric Co.,  
and U. S. Army  
Instructor of Radio  
  
Technically edited by  
**F. H. DOANE**



**\$1**

## Just off the press

**T**HE greatest book on Radio ever written. Price only \$1. Filled with sound, practical, tested information for every radio fan, from beginner to hard-boiled owl. Written, compiled and edited by radio experts of national reputation.

Every page tells you something useful. And there are 562 pages! More than 150 illustrations and diagrams! Note this partial list of contents:

Different types of receiving and sending hook-ups, electrical terms, condensers, oscillating circuits, coupled circuits, induction coils, antenna systems, electric batteries, generators and motors, protective devices, crystal detectors, arc generators, transmitters, filters, wavemeters, radio experiments, International and Morse codes, commercial receiving sets, tables and data, radio transmitting and broadcasting stations (with call letters), Radio License Regulations, etc.

## A pocket course in RADIO

You may dip into this I. C. S. Radio Handbook at random, or hunt up special information you want, or read it right through. It's interesting—fascinating—profitable! Hundreds of suggestions for helping you get more pleasure out of Radio. Will save you from wasting money on things that won't work. Money back if not satisfied.

Send \$1 to-day and get this 562-page I.C.S. Radio Handbook before you spend another cent on parts.

International  
Correspondence  
Schools  
Box 8283  
Scranton, Penna.

I enclose One Dollar. Please send me—post-paid—the 562-page I. C. S. Radio Handbook. If it is understood that if I am not entirely satisfied I may return this book within five days and you will refund my money.

Name   
Address

## Mail the coupon TO-DAY

**SEND NO MONEY**

**Guaranteed!**

**\$3.98**

**5 DAYS TRIAL**

**AMBASSADOR  
LONG RANGE PHONES**

TOWER MFG. CORP., 98 BROOKLINE AVE., BOSTON, MASS., DEPT. 7

### RADIO ENGINEER

With six years' experience in designing, repairing and manufacturing of radio apparatus, wants a position with some reliable radio company where there is chance of advancement. Associate Member Institute of Radio Engineers. **BOX 140, RADIO NEWS**

minals. This procedure is repeated at several different frequencies, and a curve plotted. The curve will show the variation of the secondary peak voltage with frequency, with a constant primary voltage of 2. It is desirable to make measurements with various amplitudes of primary voltage as well as various frequencies. In this way, a very interesting set of curves of a number of transformers were obtained, four of which are shown in Fig. 6.

Curve A in an actual curve of a 3½:1 ratio transformer and curve B that of a 6:1 ratio transformer made by the same manufacturer. These two curves were taken as samples to show the effect of ratio. It will be noted that this particular 6:1 ratio transformer will give much higher amplification in the neighborhood of 1200 cycles than at lower or higher frequencies, whereas the 3½:1 ratio transformer gives practically uniform amplification over a wide range of frequencies. This 3½:1 transformer was one of the best obtained from 24 different instruments. Curve C was obtained from another transformer that is also considered one of the best. This curve is almost the same as curve A on the lower notes but increases on the higher. This is an advantage as most loud talkers do not reproduce the higher notes, above 5,000 cycles, as loud as the lower ones. Curves A, B, and C were taken from transformers constructed according to Fig. 3, and all had a core somewhat larger than that of the average transformer. Curve D was taken from a transformer constructed according to Fig. 2, and is typical of the majority of transformers of both constructions. Practically all are inefficient on frequencies below 630 cycles; only three were found to be efficient on frequencies as low as 350 cycles, and A and C are the curves of two of them.

Some writers recommend the use of a high ratio transformer in the first stage and lower ratio transformers in succeeding stages of amplification, but this is not good practice for the following reason: The least distortion introduced in the first stage is considerably amplified by the following stages, and its effect will be greater in the loud talker than the effect of the distortion introduced in the second or third stage. Therefore, the transformer used in the first stage should have the least distortion and not the most, which would be the case if a high ratio transformer was used.

In Fig. 4 is shown an improvised transformer made up of an iron wire core and two 4½:1 ratio amplifying transformer windings. The primaries and secondaries are connected in series, as shown. This transformer proved exceptionally good; the curve was the same shape as curve C, except that the transformer was not quite as efficient on frequencies below 630; although it was much better than the majority of transformers now on the market. If 3:1 ratio coils were employed, better results would probably be obtained. With only one coil on the iron wire core, the instrument was very poor.

If a small condenser, about .00025 mfd. capacity, is shunted across the secondary terminals of a transformer, it absorbs the higher notes more than the lower ones, and improves transformers which amplify the high notes too much. If a high resistance of about 1 megohm, is connected across the secondary terminals, it absorbs the lower notes, and improves high ratio transformers having curves similar to curve B. But it is better to use good transformers in the first place and not try to improve a poor one with condensers and resistances.

### NOTICE

Mr. Leonard Humphries (5GB), of 61 Geriant Street, Princes Park, Liverpool, England, would like to correspond and exchange photos with American amateurs.



Pat. Pending  
Price \$35.00  
Jobbers and Dealers  
Write for  
Proposition

## STATIC and Inter- ference is Reduced to a Minimum

## Better Reception with the NASSAU



Eliminates Aerial and Ground.

**The Secret is in the Patented Winding  
1500 MILES ON LOUD SPEAKER**

With 2 stages radio and  
2 stages audio frequency amplification.  
Write for Circular "R"  
Manufactured by

**NASSAU RADIO CO., Inc.**  
60 Court St., Brooklyn, N. Y.

**A Five Year Guarantee  
GOES WITH EVERY**

## ARTHUR PUDLIN VARIABLE HIGH RESISTANCE LEAK

Can Be Used for Panel Mountings  
Endorsed by  
Leading Radio Engineers of the Country

We will at any time within a period of 5 Years replace free of charge any Arthur Pudlin Variable High Resistance Leak that does not work satisfactorily.  
This leak is guaranteed to give a resistance from 1/10 to 5 megohms.



COMPLETE WITH BASE  
Price with .00025 Mica Condenser...\$1.00  
Price without Condenser.....75c  
If your dealer does not carry them, send purchase price and dealer's name to

**Arthur Pudlin Engineering Co.**  
Dept. R.N. 110 West 40th St., New York  
We also Manufacture  
Tubular Glass Grid Leaks in All Megohms, 25 cents

(Patent Pending)

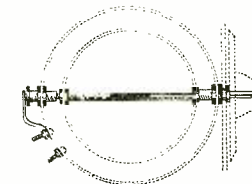

DANIEL Radio Specialties are PROVEN specialties—proven under actual test. Wherever they have been introduced they enjoy big sales because of the confidence of both dealers and radio fans.

Our Special Introductory Proposition To Dealers and Representatives, Is Particularly Interesting. Write For It.

**R. W. DANIEL,**  
Manufacturer and Distributor  
5232-38 MELROSE AVE., LOS ANGELES, CALIF.



## A High Frequency Alternator for Tone Modulation

(Continued from page 560)

The armature coils are best form wound, taped, and then fixed in position on the armature core. The leads from the armature and field windings should be brought out to binding posts mounted on a connecting block fastened to the base on which the alternator is assembled.

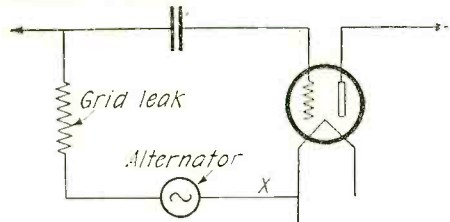

Fig. 2 A

Inductor Alternator Placed in Grid Circuit of Oscillator for I. C. W. Transmission.

The alternator described can be used in a number of circuits to modulate the output of an oscillator or bank of oscillators. Two circuits are suggested in Fig. 2. The circuit (A) shows the alternator included in the grid circuit of an oscillator, so that the voltage fluctuations of the alternator are impressed on the grid of the oscillator, causing the oscillations of the latter to be periodically interrupted. A more flexible arrangement is secured, however, by coupling the alternator to the grid circuit of the oscillator, using electro-magnetic coupling so that the oscillations of the generator can be partially or completely modulated, as desired, by varying the coupling between the alternator and oscillator circuits.

The circuit illustrated in Fig. 2, (B), shows how a radiophone transmitter can be used for tone telegraphy. The D.P.D.T. switch connects the microphone or alternator to the primary of the modulation transformer, as desired. In either of the circuits illustrated, the transmitting key can be located in the output circuit of the alternator, as

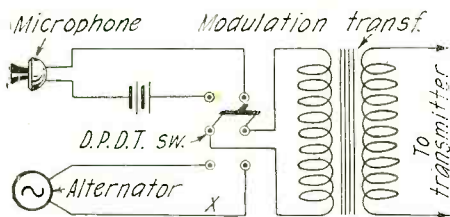

Fig. 2 B

Scheme of Connections for Alternator When Used to Modulate Output of Radiophone Transmitter for Telegraphic Purposes. The Transmitting Key May Be Inserted in the Circuit at the Point Marked X in the Diagram.

indicated by the letter X in the diagrams, or it may be placed in the D.C. circuit exciting the field of the alternator. When the alternator is inductively coupled to the grid circuit of an oscillator, or when placed in the grid circuit, the transmitting key can be located in other places in the tube circuits than those associated with the alternator, although in transmitters employing power tubes of high ratings as oscillators considerable care should be used in locating the key. In circuits where a lower power tube is used as an oscillator to excite a bank of power tubes, either circuit illustrated in Fig. 2, can be used, the alternator being coupled to, or included in the circuits of the master oscillator.

9AYX

QRA, 9AYX, Ray Keller, 1315 N. 2nd Street, Belleville, Ill. Will QSL all cards.

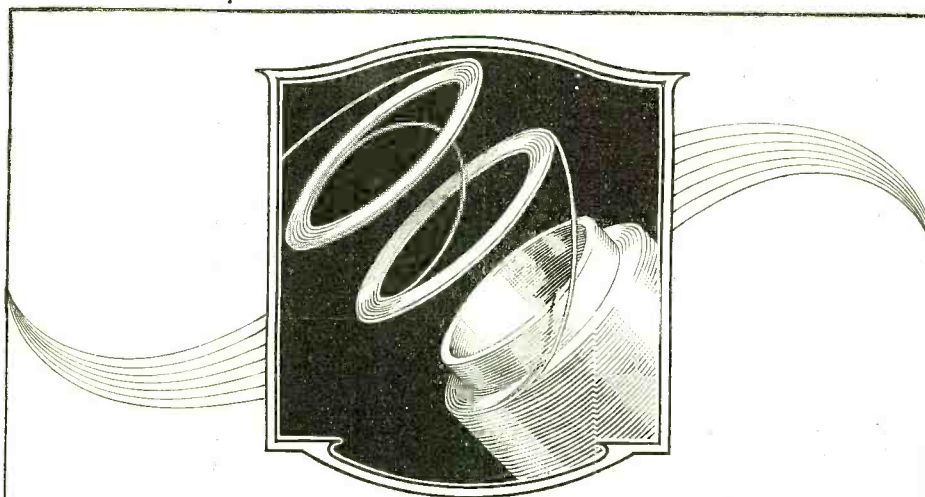

## Helical Wound Coils

—less distributed capacity, no distortion, and 40% more amplification

ONLY one transformer has or can have Helical Wound Coils, so only one transformer can give you the results you want. That is the Samson HW-A1 Audio Frequency Transformer.

Helical Winding lays a very much less number of turns in each layer than any other method of winding. Consequently there is less electrical pressure between adjacent wires and less distributed capacity.

Test the Samson yourself; prove to your own satisfaction what everyone who has ever tried the Samson has discovered—that it is the most satisfactory audio frequency transformer possible to produce. Ratio: 6 to 1. Price, \$7.00.

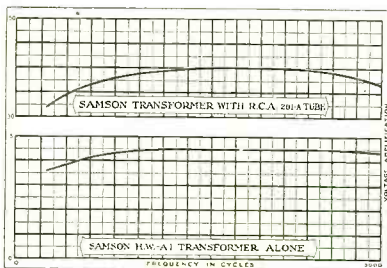

SAMSON ELECTRIC COMPANY  
FACTORY: CANTON, MASS.

Sales Offices: Boston, New York, Philadelphia, Pittsburg, Chicago, Cleveland, Detroit, Indianapolis, St. Louis, Minneapolis, San Francisco, Los Angeles, Portland, Montreal, and Toronto.

## Samson HW-A1 AUDIO FREQUENCY Transformer

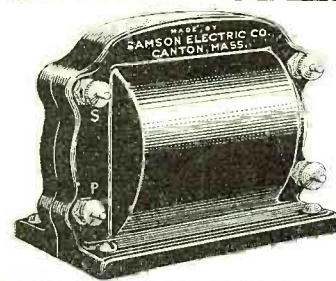

## Saw Your Own Bakelite — Save Money!

Stop sending this work out. Save time and money by sawing bakelite in your shop on a

### Boice Junior Bench Saw

Small, compact, low-cost; all metal construction. Saws 1/2" bakelite smoothly and rapidly. Special rim guide enables panels as large as 10"x10" to be cut in half with accuracy. Handles 1 1/2" wood, 1/2" copper, carbon, asbestos board, etc. Easily driven by 1/4 or 1/3 h.p. motor. Attaches to any light socket.

Write NOW for circular on this and other Boice-Built Bench Machines and Motors.

W. & J. BOICE Dept. 811 TOLEDO, OHIO

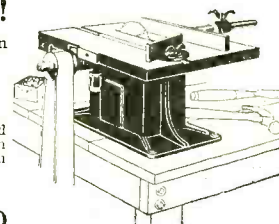

PROLONGS LIFE OF TUBES

## AMPERITE

AUTOMATIC FILAMENT CURRENT ADJUSTER  
ELIMINATES RHEOSTATS

EXPELS ALL TUBE TROUBLES

FROM YOUR DEALER OR  
RADIAL COMPANY  
89 WARREN STREET, NEW YORK

\$1.10 WITH MOUNTING

## VULCANIZED FIBRE

Be sure and specify "WILMINGTON FIBRE"

Sheets, Rods, Tubes, Washers, Etc., Specialties

Wilmington Fibre Specialty Co. Wilmington, Del.  
Branch Offices "Everywhere"



**\$15.00**  
F.O.B. Cleveland.  
Type 6 Charges 6 Volt Storage Battery from any 110 Volt 60 Cycle lamp socket at average rate of 6 Amperes.

**3,250 Hours' Service From a \$15.00**

**F-F BATTERY CHARGER**

"Dear Sir: Find enclosed fifty-four cents for which please send one set of carbon brushes for an F-F Battery Charger, Type 6.  
"This charger has been in use on an average of 25 hours a week for about two and one-half years and the Carbons have never been renewed. The machine is giving very good service. Yours very truly,  
(Signed) "Ralph C. Peters."  
"1810 Pine St., Boulder, Colo."  
This unsolicited report is but one of thousands. Every mail brings additional appreciation for the unusual reliability, and freedom from "grief", enjoyed by F-F owners.  
This is the result of ten years' specialization, after making the first satisfactory mechanical battery charger years ago.  
You, too, can benefit just as Mr. Peters above, by insisting on the F-F Charger.  
There's a type for every need. Buy from your dealer. If he cannot supply you, write for literature or enclose remittance covering express or postal charges on 9 lbs.  
It's Free  
Write for Eulletin No. 32  
Dealers get the F-F Proposition

**The France Mfg. Co.**  
10432 Berea Road  
Cleveland, Ohio

*Pioneer Manufacturers of Patented Battery Chargers*

**Throw Those Taps Away**  
(Continued from page 560)

receive them. Accurately spaced holes are required, or the switch lever will not glide smoothly over the contacts. All this means a tedious carefulness that can easily be avoided.

Electrically, the system is inefficient. Since the contact formed between the switch blade and the contact points is solely through the aid of pressure, the device possesses a certain amount of electrical resistance, inherent in any such contact. This contact resistance increases with time, for the contact surfaces become tarnished and corroded and particles of dirt and grit lodge themselves between the individual contact points, thus forming a high resistance leak from contact to contact. All of these resistances contribute in no small measure to the losses in the circuit.

A tapped inductance has one great disadvantage in that the taps increase the effective resistance of the coil. Actual measurements prove this to be true. Fig. 2, drawn from a paper by J. H. Morecroft (Proc. I. R. E., Vol. 10, No. 4, p. 273) gives some interesting data.

It will be seen that for all wave-lengths, the curve corresponding to coil C has the greater ratio of reactance to resistance, or

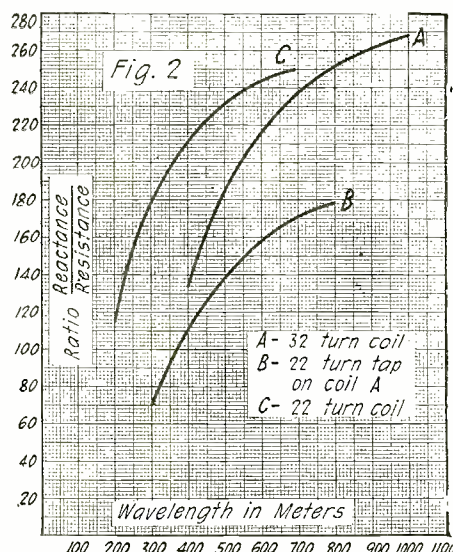

**Fig. 2**  
A- 32 turn coil  
B- 22 turn tap on coil A  
C- 22 turn coil

**A Tapped Coil Has Considerably More Resistance Than an Untapped Coil as Can Be Seen from These Curves.**

in other words has a lower effective resistance than coil B, which constitutes the first 22 turns on the 32-turn coil A. The resistance of the untapped coil in this particular case is about 40 per cent. less than that of coil B. For a radio circuit, coil C is to be preferred, especially in a receiving circuit where the energy coming in over the antenna is exceedingly minute. If we can offer a low resistance path for the flow of this energy, we have gained just that much. In addition, coil C can tune to a lower wave-length due to the fact that it has no taps on it to add to its distributed capacity.

Let us now take up the untapped coil, some familiar examples of which are the loop antenna, concentrated inductances (honeycomb, duo-lateral), etc. In order to keep a large ratio of inductance to capacity, we must necessarily use a large inductance and a small capacity. This can be accomplished by the proper designing of the coil. As there have been, in the past, several articles in RADIO NEWS and other magazines dealing with the design of inductances, we need give but a very bare outline of the

**R RIGGS R RECTIFIER R**  
**\$12.50**



Prepaid Anywhere in the U. S.

**Money Back Guarantee**  
We guarantee the Type B-3 to please you. If it does not, return it and we will return your money.

**THE RIGGS MFG. CO.**  
Eastern factory Urbana, Ohio  
Western factory Everett, Wash.

**ILLINOIS '199' CUSHION SOCKET**

**SOCKET FLOATS ON RUBBER**

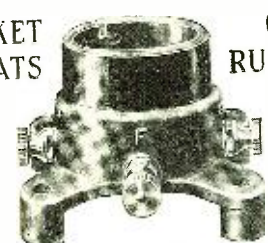

Model B for Small Base Tubes UV-199 and C-299, \$1.00 postpaid.

**"UNIVERSAL" PHONE CONNECTOR**



Accommodates 1-7 pair phones, either with cord tips or plugs, spade tips or wire. Price \$1.50 postpaid. Dealers write.

**ILLINOIS RADIO CO.**  
Springfield Illinois

**RADIO GOODS at BARGAIN PRICES**

Cunningham C-300 Tubes	\$.439
Cunningham C-301-A Tubes	5.89
W. D. II Tubes	5.89
1 1/2 V. Mercury Tubes, Standard Base, Best Made	5.25
22 1/2 V. Var. Cyclone B. Battery	1.00
22 1/2 V. Var. Cyclone B. Bat. med.	1.25
Large	1.75
45 V. Var. Cyclone B. Battery	2.95
2200 Ohm Varco Phones	2.95
Original Nathaniel Baldwin Phones, Type C	8.95
Remler Rheostats or Sockets	.59
Magnavox	30.00

Numerous other bargains in our FREE PRICE LIST, sent upon request. Goods shipped PREPAID PROMPTLY on receipt of remittance. All merchandise guaranteed.

**BERGEN RADIO SUPPLY CO.**  
606 Bergen Ave. New York City

**CABINETS**

Solid Mahogany. Beautiful hand rubbed finish. Only a limited number at these bargain prices.

**PANEL SIZE**  
6x6-\$2.40 6x9-\$2.70 6x12-\$3.00  
6x15-\$3.25 6x24-\$3.75

All 7" Deep, Transportation paid east of Rockies  
Write for list of other radio bargains.

**E. W. BENHAM**  
Dept. I.  
6534 Kenwood Ave., Chicago, Ill.

**HOLD-TITE JACKS**  
CODE NO. 101

Mount without spacer washers. Phosphor-bronze springs. Bought by those who require the best. Catalogue free.

**Carter Radio Co.**  
207 S. State St. CHICAGO

design requirements. It is hoped that in a future article the necessary details may be presented with a complete example worked out to show the method of procedure.

To cover a given wave-length band, we have limited ourselves to a capacity-in shunt with the coil, of only 250 micromicrofarads. Hence our coil with this maximum condenser value must be able to respond to the upper limit of the wave-length band. To get the necessary inductance, the easiest method is to look up the oscillation constant squared (L C value) of the longest wave-length desired. (See Lefax sheets for a table of these values.)

By a very simple algebra step we can solve for L the required inductance. It is understood that for very long waves our capacity may be made as large as 1,000 micromicrofarads without losing our desired ratio of inductance to capacity. It is now necessary to see if this combination of inductance and capacity just obtained will respond to the lowest desired wave-length. Here an assumption will have to be made for the minimum value of the condenser, which we may take to be about 15 micromicrofarads for a 23-plate condenser and about 20 micromicrofarads for a 43-plate condenser. Knowing our inductance value from the previous calculation, we take the product of its value and that of the assumed capacity and look up the table for the resonant frequency and wave-length. We now have the wave-length band that our particular coil and condenser will be able to cover.

In calculating an inductance that is to be used in the antenna circuit, the capacity of the antenna must be taken into account. For the average amateur aerial the value of the antenna capacity is taken as 250 micromicrofarads. For loop calculation the reader is advised to consult the Bureau of Standard's Bulletin No. 74 on the inductance of loops.

To sum up the advantages of the untapped coil-condenser method of wave-length control:

1. No extra control is introduced into the circuit. The condenser is merely used in place of the switch and taps. Furthermore, with a vernier adjustment on the condenser, the tuning is infinitely finer than that obtained by means of units and tens taps.
2. Just as broad a band of wave-lengths may be covered with the condenser as with taps off the coil. Furthermore, there are no "dead-end" effects in the coil since the entire inductance is in use all the time.
3. It is better than a variometer control, as there is no steep rise of resistance as the minimum resonance point is approached, such as is the case when the variometer is in the position where its rotor winding is in opposition to the stator winding.
4. The design is not difficult and with a little patience the essential points may be mastered by even the novice.

### A Single Tube Reflex Receiver

(Continued from page 529)

as tight as possible. Then the coils can be gradually separated and the primary condenser slowly turned toward zero, to increase the volume of output (up to a certain point) and to sharpen the tuning.

Only a good rheostat capable of vernier adjustment should be used with a reflex set, because the filament is very critical. The tube must be kept just below the oscillation point for best results. To reach and yet

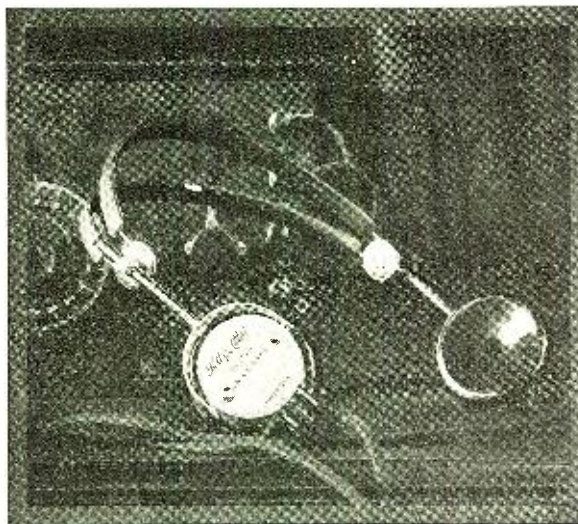

## THE RADIO EXPERT KNOWS

That the varied and harmonious strains of music coming through his set—are nothing but electric current till they reach his headphones

That the highest priced outfit is mediocre without the best headphones obtainable.

That perfect headphones preclude scientific knowledge, superior skill, and long experience in their manufacture.

That the Holtzer-Cabot Electric Company has devoted 25 years of constant research and painstaking manufacture to sensitive telephone instruments.

That the perfected Holtzer-Cabot Universal No. 2 is the ideal Headset for any radio outfit.

Holtzer-Cabot Universal No. 2, \$8.50

Holtzer-Cabot National No. 4, \$5.50

*Be Sure to send for a copy of our booklet*

*"What You Should Know About Radio Reception."*

THE HOLTZER-CABOT ELECTRIC CO.  
125 AMORY STREET, BOSTON, MASS.  
6161-65 South State Street - - Chicago, Ill.

Dept. D

*Holtzer-Cabot*  
BUSINESS ESTABLISHED 1875

### HEAD-SETS

#### PERFECT CONNECTIONS

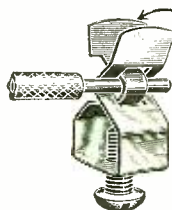

are always sure with Fahnestock Patent Wire Terminal Grips Like a Vise Eliminates Vibration Easily Attached No Soldering Best of All for RADIO OUTFITS

Clip No. 45 (Illustrated) especially

Adapted for Bus Wire

Made in all Sizes and Shapes At your Dealer's

**FAHNESTOCK ELEC. CO.**

East Ave. and 8th St.  
Long Island City, N. Y.

## RUSONITE

CRYSTAL RECTIFIER

(Patent Pending)

THE PERFECT SYNTHETIC CRYSTAL DETECTOR SENSITIVE OVER ENTIRE SURFACE

No Hunting for "Spots," Loud and Clear. Endorsed by Thousands of Satisfied Users.

Sensitiveness	Price	50c
Guaranteed	Mounted	

14 K. Gold Supersensitive	Price	25c
RUSONITE CATWHISKER:	Permanent - Will not Oxidize.	

Manufactured Expressly for Reflex Circuits Will Stand Up Under Heavy Plate Voltage	Price	\$1.00
Guaranteed	Mounted	

Order from your dealer or direct from

**RUSONITE PRODUCTS CORP.**

15 Park Row

New York, N. Y.

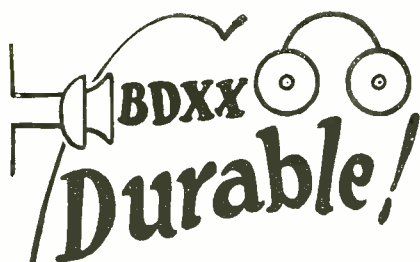

**B D X X panels are PERMANENT. Their service is unending. Once installed, they satisfy for all time. Never has it been necessary to replace one.**

**bakelite dilecto!**

*(A Laminated Phenolic Condensation Material)*

**Highest in dielectric strength. Surprisingly hard and tough; yet readily machined. Proof against water, heat, fumes, solvents and milder acids. Ozone from high-voltage electrical apparatus, which quickly ruins hard rubber, has absolutely no effect on Bakelite-Dilecto.**

**X X grade Bakelite-Dilecto has every radio advantage. Insist on it at any electrical store.**

**The Continental Fibre Co.,  
Factory: Newark, Delaware**

*Dealer Service From:*

New York, 233 Broadway  
Chicago, 332 S. Michigan Ave.  
Pittsburgh, 301 Fifth Ave.  
San Francisco, 75 Fremont St.  
Seattle, 1041 Sixth Ave., South  
Los Angeles, 411 S. Main St.

**RADIO SCHOOL**

All our graduates are placed.  
Shortage still exists. Wages going up.

Send for Catalog

**MASSACHUSETTS RADIO & TELEGRAPH SCHOOL, Inc.**  
18 Boylston St. Boston, Mass.  
C. R. ENTWISTLE, Radio Director

**Crystal Detectors Sacrificed**

Either complete, or in parts; parts being standard and suitable for use on any detector. As we have discontinued the manufacture of wireless parts, we are offering the above at **PRICES FAR BELOW ACTUAL COST.**

Samples sent on receipt of inquiries on printed letterheads  
**BIERMAN-EVERETT FOUNDRY CO.**  
Irvington, New Jersey

not pass this point with a cheap rheostat is almost impossible. I use a Bradleystat with satisfaction, although a vernier knob would be an advantage. As will be seen, the Bradleystat is attached to the front support of the coil mounting, where the knob is convenient and the leads to tube and batteries are short.

Quality is essential in the crystal detector, also. Mine has a very valuable feature—a rotating crystal mounting. Often when a sensitive spot has been found, the signals are both strengthened and clarified by slowly turning the crystal without lifting the cat-whisker. This is particularly desirable with a reflex set, which, when operating properly, will break into violent oscillation if the cat-whisker is lifted, or placed on a relatively non-sensitive spot.

The fixed condensers are very important, since they by-pass the radio-frequency impulses and so permit dual amplification with one tube—first at radio and then at audio frequency. The condenser between the ground side of the secondary inductance and the positive terminal of the tube is not absolutely necessary, but it materially increases the volume of output.

Special care must be used, in hooking up a reflex set, to connect the audio-frequency transformer as shown. Because many diagrams do not letter the terminals of this transformer, it is easily possible to have it so connected as to be inoperative, the circuit then functioning as a tube detector, without reflex action.

Those who wish to use a variocoupler instead of honeycomb coils may dispense with a primary condenser if the stationary coil is tapped for single-turn variation and has sufficient wire to reach all broadcasting waves.

Even more than with other types of receivers, short battery leads are very desirable with the reflex. These are best obtained by placing the "A" and "B" batteries directly back of the set, or in a drawer or on a shelf just under it.

Ninety volts on the plate of the 201-A tube gives satisfactory results. Either three or four dry cells (preferably "twins") may be used in series to light the filament. If four cells are used with a Bradleystat a small resistance is needed on the lower wavelengths while the cells are fresh. This resistance may be fixed, or variable by placing a second rheostat in the filament circuit, near the batteries, to compensate for fluctuations in current as the "A" battery runs down.

The output of this set is sufficient to operate a loud speaker. One or more stages of straight audio-frequency amplification may be added in the usual manner, but this tends to lower the quality of speech and music, nor is additional volume needed as a rule.

Even those unfamiliar with tuning a receiving set should have no great difficulty with the single-tube reflex if properly constructed. First make sure that catwhisker and crystal are in contact, then turn up the filament and vary coupling and condenser and crystal settings until a station is picked up and tuned to maximum volume. Then advance the rheostat as far as possible without "spilling" the tube or muddling the signals. Usually, distortion is not noticeable until the tube actually breaks into oscillation.

If, while tuning, the set emits raucous sounds, the filament is too high or the crystal is not adjusted to sensitivity. The tendency to oscillate increases as the secondary condenser approaches zero, and rotation of the primary condenser in the same direction sometimes produces this effect. Very careful adjustment and readjustment of all controls will be amply repaid in volume and quality of output. With each variation in filament current a slight change in the secondary condenser setting is necessary.

**W. T. 501  
Detector Tube**

**\$2.00**  
Immediate Delivery

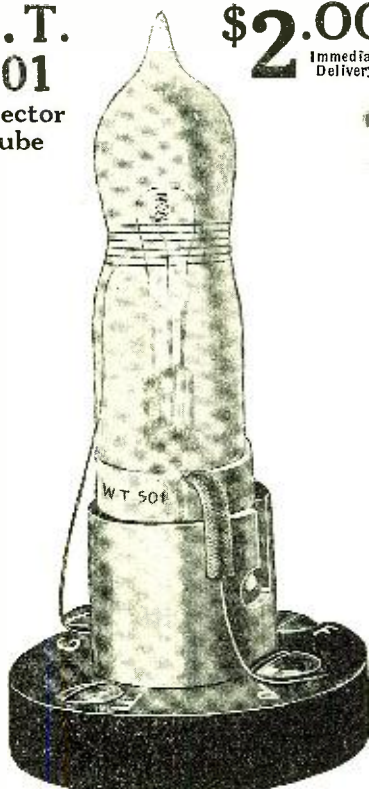

PACKED 10 IN COUNTER DISPLAY CARTON

ASK THE MAN WHO OWNS ONE

Operates on dry cells or regular 6 V. A battery. Wiring diagram packed with each tube showing how to use the W. T. 501 with any crystal set or tube set.

Special sockets 40c, adaptors 75c, insurance 10c  
**RADIO RESEARCH GUILD**  
40 Clinton St.  
Newark, N. J.

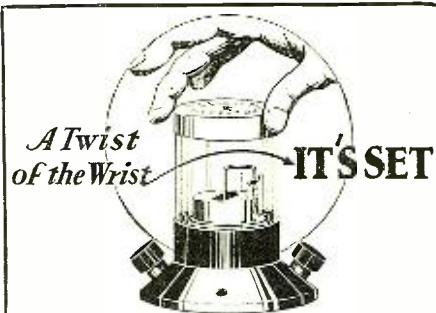

**YELLOWTIP  
MICROMETER ADJUSTING  
CRYSTAL DETECTOR**

The every-purpose detector—fixed or changeable adjustment, just as you desire. Tune with the YELLOWTIP. No hunting or looking for a sensitive spot—just "A Twist of the Wrist—It's Set". Micrometer adjustment in a moment, fixed indefinitely. Ideal for reflex and other circuits.

**\$2**

Write for folder and name of your nearest dealer.

**WHOLESALE RADIO EQUIPMENT CO.**  
Exclusive Factory Representatives  
38 WILLIAM ST., NEWARK, N. J.  
Dealers and Jobbers write for attractive proposition.

**BECOME A PROFESSIONAL PHOTOGRAPHER**



**EARNING \$35 TO \$125 A WEEK**  
Three to six months' course. Motion Picture, Commercial, Portraiture. Practical instruction. Modern equipment. Ask for Catalog No. 56.

**N. Y. INSTITUTE OF PHOTOGRAPHY**  
NEW YORK CHICAGO BROOKLYN  
141 W. 36th St. 630 S. Wabash Ave. 505 State St.

**MICHIGAN RADIO CORPORATION  
GRAND RAPIDS, MICH.**

As regards actual results obtained with this set: One local station (WJAX) is heard all over the house, the other (WHK) loud enough for the living room by attaching a Baldwin phone to the horn of an Edison phonograph. Out-of-town stations come in on the headset with surprising loudness and substantial freedom from the disturbing noises so often associated with detector—two stage outfits. In mid-summer, stations as far distant as Chicago are heard clearly, and Detroit and Schenectady never better with any set that I have tried.

Some may object to the crystal detector, but slight difficulty in adjusting it at times is more than compensated for by the quality of output. Also, it is less expensive than a tube detector, and lasts indefinitely.

## Design of an Audibility Meter

(Continued from page 552)

In this way each half of the winding will be wound in opposite directions to the other.

The resistance values are so selected as to balance a 36,000-ohm headset, which in the author's case was found when 1,000 cycles were used. It is improbable that ordinary receivers will go much higher than this value. In all events the resistances that are selected for use with the five-point switch, to compensate for changes in receiver impedance with frequency, should be so chosen that the total resistance in the receiver circuit is 36,000 ohms. More than five points may of course be used on the switch if greater accuracy is desired, or if the receiver impedance changes rapidly with frequency.

Should the use of the frequency compensation switch seem unwarranted, it can be omitted, but the correction factor for various frequencies must be computed from the formula, for each of the 34 switch points. These factors can be plotted or tabulated for ready reference.

CHART 8

Amp.	Tap	Factor	Res.	Amp.	Tap	Factor	Res.
				18	100	78	
2	2.5	12000		19	120	60	
3	4	12000		20	150	60	
4	5	3000		21	200	60	
5	6	1800		22	250	36	
6	7	1200		23	300	24	
7	8	865		24	400	30	
8	10	1040		25	500	18	
9	13	1000		26	600	12	
10	16	600		27	800	15	
11	20	510		28	1000	9	
12	25	390		29	1500	12	
13	30	255		30	2000	6	
14	40	325		31	3000	6	
15	50	180		32	4000	3	
16	60	124		33	5000	2	
17	80	155		34	∞	7.5	

A Chart Giving the Audibility Factor for Each Tap on the Switch of the One Described.

Chart 8 shown above gives the values representing the audibility factor for each tap on the switch, together with the value of the resistance unit connected between that tap and the preceding one, as in Fig. 3. Fig. 4 gives the values of the resistances connected to the first eight taps of the inner arc of the main switch. These eight points should be in alignment radially with the first eight taps of the main switch outer arc.

While this meter may seem too expensive and complicated to all except the serious minded experimenters, it will prove much cheaper than a similar instrument purchased outright for a radio club. About .25 pound



## Music's charms cease when batteries fail

Your radio set works best on near and far stations, only when your batteries are delivering ample current.

Storage batteries, tuned up with Tungar, give the fine results which the owner of a high class radio set is justified in expecting from his instrument.

With Tungar—the go-between from house lighting circuit to storage battery—you do not need to move the battery, or buy a new one. Just attach to a lamp socket or a convenience outlet, turn on the current and leave it, any time, day or night.

Tungar is certain, clean and quiet. There are no moving parts to get out of order or to make noise. Its cost of operation is low.

For years motor car owners have used Tungar for charging their automobile batteries. See one at any good electrical shop, or write for literature. Address Section RA 11.

Merchandise Department  
General Electric Company  
Bridgeport, Connecticut

Tungar Battery Charger. Operates on Alternating Current.

(Prices east of the Rockies)

2 Ampere. Outfits Complete—\$18.00

5 Ampere Complete—\$28.00

Special attachment for charging 12 or 24 cell "B" Storage Battery—\$3.00

Special attachment for charging 2 or 4 volt "A" Storage Battery—\$1.25

Both attachments fit either Tungar



Charge 'em at Home, with

# Tungar

## BATTERY CHARGER

55A-103D

A GENERAL ELECTRIC PRODUCT

JUST THE BOOK YOU WANTED

**RADIO NEWS**  
**Amateurs' Handibook**  
*by the most eminent Radio Experts*

EXPERIMENTER PUBLISHING COMPANY, INC.

**"Radio News"**  
**Amateurs' Handibook**

*Volume No. 1*

A thick full of radio constructive and instructive articles from cover to cover. Written by foremost radio authorities, in plain everyday language which everyone can understand. Sections include articles on Receiving Sets and Sundry Apparatus, Transmitters and Accessories, Radio Theory, Vacuum Tube Data, and Practical Hints for the Amateur. A book which also serves as a ready reference and should find a place in the library of every amateur. It contains 221 pages and over 375 illustrations, diagrams, and photographs, bound in a multi-colored heavy board.

On sale at all leading radio stores. If your dealer cannot supply you, fill in a dollar bill to this ad and write your name and address in the margin below, and book will be forwarded to you postpaid.

**EXPERIMENTER PUBLISHING CO., INC.**  
53 PARK PLACE, NEW YORK

PRICE, \$1.00

# KC RADIO

**KUALITY CERVICE**  
**Kilbourne & Clark Mfg. Co.**  
 Head Office and Works: Seattle

**BRANCH OFFICES**

PORTLAND 305 Larrabee St.	SAN FRANCISCO, 591 Mission St.
LOS ANGELES, 1103 W. 10th St.	NEW YORK CITY, 80 Washington St.

For 10 years we have built radio apparatus for ships, shore stations, U. S. Navy, amateur and experimental use.

**OUR MERCHANDISING LINE**

- |                |                   |
|----------------|-------------------|
| Receivers      | Plugs             |
| Amplifiers     | Jacks             |
| Head Phones    | Adapters          |
| Loud-Speakers  | Sockets           |
| Condensers     | Amp. Transformers |
| Rheostats      | Variometers       |
| Potentiometers | Variocouplers     |
| Switches       | C. W. Apparatus   |

**COMPLETE LINE OF MOULDED PARTS**

WATCH THIS SPACE FOR THE LATEST SPECIALTIES

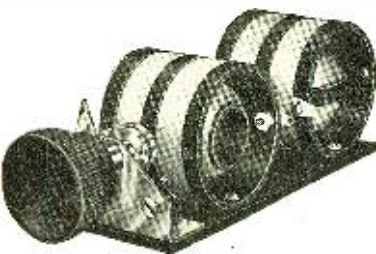

**VARIABLE RADIO FREQUENCY AMPLIFYING TRANSFORMER (Midget Size)**

Two Stage, 2"x2"x5½" .....\$10.00  
 Single Stage, 2"x2"x3" ..... 5.50  
 Range 150—550 meters

CAN BE ACCURATELY TUNED TO ANY WAVE LENGTH BETWEEN THESE LIMITS (NOTE SMALL DIMENSIONS)

**FOR \$1.00 THIS IS WORTH LOOKING INTO**

For distance, volume, clearness, selectivity, simplicity and ease of operation, it has no equal. Hundreds of others have tried it and all agree. Only two controls, no shielding, no freak coils or other doo-dads necessary. Entire set of standard stock material, can be built for \$17.50. The complete book-up, simple description, list of all materials and where to get them. We sell no parts, only book-up and how to build. This will save you at least \$50.00 on your set and you can't buy a better one for less than \$200.00. All questions answered for 10c stamps. **Any Complaint—Your \$1.00 Back.** My radio experiments, during the last 13 years have cost me, not less than \$10,000.00. The result is yours for \$1.00. Nothing accepted, but U. S. Money Order. **E. F. WAITS** Corinth, Miss.

**Chaslyn**  
 Tests your battery instantly by the way the Balls sink or swim in the acid outfit, including Hydrometer, Depth Gauge, and Water Filler. Postpaid \$1.00 Circular Free. Chaslyn Co., Dept. 2845 Ravenswood Ave. CHICAGO

of No. 36 resistance wire will be needed (or .10 pound of No. 38) depending on the type of wire used. This estimate assumes that five 12,000 ohm resistance units are purchased made up.

It is to be noted that if only one receiver is used in making a test instead of a pair, each resistance should be only one-half as large. Such a change would of course cut the trouble and expense of winding the units, in half.

## The Static Frequency Multiplier

(Continued from page 557)

The principle of frequency trebling by saturation even with alternating current has been described, in particular, by Mr. Joly. For that matter, the third harmonic very often occurs in ordinary power transformers.

In order to make this harmonic manifest itself under efficient conditions, particular connections were resorted to and different diagrams tried out.

In Fig. 2, the alternator 1 of frequency  $f$  outputs through a compensating condenser 2 onto a network comprising: the multiplier 3 made up of a magnetic core inductance coil, a condenser 4 approximately balancing the inductive reactance of the multiplier at frequency  $f$ , the rejector 5 barring the sought harmonic of  $f$ , and the variable condenser 6. In shunt to the multiplier 3 and its compensating condenser 4 are branched the resonant shunts 8, 9 and 10 for the different harmonics to which the multiplier gives rise. A load resistance, such as 11 shown in the third harmonic shunt of Fig. 2, is inserted in the circuit of that harmonic from which it is desired to draw power. The resonant shunts for the higher frequencies may be real short-circuits for currents of those frequencies. The condenser inserted in the sought or useful harmonic shunt is adjusted so as to allow of maximum power output.

In order to accelerate the starting of the system, i.e., to rapidly obtain the strong current régime of the ferro-resonant system constituted by the circuit described\*, means are provided whereby the number of turns on the multiplier 3 may be decreased at the starting and then gradually brought up to its operating value. In fact, the strong current régime necessitates, for its stable operation, that the condenser 6 have a value lower than that which would exactly produce resonance. Under these conditions, the system just described will take a leading current. In order to compensate this effect, a variable inductance 7 taking a lagging current is branched in shunt to the system. Thus, it occurs that the alternator output current is less than that which traverses the multiplier. In any case, it is possible to adjust the condenser 2 and the value of its capacity may be different than that which exactly compensates the internal alternator reactance at frequency  $f$ .

Fig. 3 illustrates another arrangement. In this latter case, the alternator outputs onto the multiplier 3 and the rejector 5 without the insertion of any condenser so as to avoid any unstableness of operation. In shunt to the multiplier are branched a series of fundamental frequency rejectors tuned to the harmonics by means of inductances. The useful or working harmonic includes a load resistance 11 in its circuit and the latter is adjusted in a particular manner. Under these conditions, the system just described takes a lagging current and this effect is compensated by a variable shunting condenser 7 which takes a leading current.

\*Concerning the two possible strong and weak current régimes which it is possible to obtain in ferro-resonant circuits see BETHENOD La Lumière Electrique Nov. 30, 1907 and BOUCHEROT Revue Gén. d'Elec., December 11, 1920.

## BUY DIRECT

### Why Pay Dealers and Jobbers Large Profits?

WD11—WD12—UV199 and UV201A Radiotrons	\$ 5.43
C11—C12—C299 and C201A Cunninghams	5.43
Trista 3000 Ohm Guaranteed Head Sets	5.44
Manhattan 2000 Ohm New Type Head Sets	5.59
True-Tone Supersensitive 3000 Ohm Head Sets	4.28
Federal Telephone Radio Head Sets	5.59
Original Nathaniel Baldwin Head Sets	9.58
Original Nathaniel Baldwin Single Units	4.79
Original Nathaniel Baldwin Loud Speaker	19.95
Madera Clearspeaker with Nathaniel Baldwin Unit	11.95
Trista Loud Speaker (fits standard head sets)	1.98
Standard 22½V. "B" Battery \$1.75 size	1.19
Standard 22½V. "B" Battery \$3.00 size	1.94
Standard 45V. "B" Battery \$5.50 size	3.77
Trista 60 Ampere Hour Radio Storage Battery	9.95
Trista 100 Ampere Hour Radio Storage Battery	14.95
Sterling 10 Ampere Battery Charger	12.79
Radio Home Charger De-Luxe	14.79
Trista Audio or Radio Transformers	1.98
All American Audio or Radio Transformers	3.82
Aene Audio or Radio Transformers	3.98
Eria Duo Reflex Radio Transformers	3.98
11 plate Variable Condenser	1.28
23 plate Variable Condenser	1.44
43 plate Variable Condenser	1.59
23 plate Variable Condenser with Vernier	2.88
43 plate Variable Condenser with Vernier	3.44
Moulded Bakelite Silk Wound Variometer	3.98
Moulded Bakelite Silk Wound Variocoupler	4.79
Trista Assembled Wooden Variometers	1.19
Trista 180° Bakelite Silk Wound Variocouplers	2.24
Lic. DeForest Triple Coil Honeycomb Mountings	3.98
Lic. DeForest Double Coil Honeycomb Mountings	2.79
Lic. DeForest Single Coil Honeycomb Mountings	.39
Bremer-Tully Air Cove Neutrodyne Transformers	1.49
Bremer-Tully Micrometer Neutrodyne Condensers	.78
Bremer-Tully Universal Vernier Tuner	3.98
Reinartz Green Silk Wound Tapped Coils	1.76
Approved Cartridge Type Lightning Arrestor	.79
Trista 6 Ohm Fada Type Rheostat	.89
Trista 30 Ohm Fada Type Rheostat	.48
Trista 200 Ohm Fada Type Rheostat	.59
Trista 6 Ohm Vernier Rheostats	.78
Trista 30 Ohm Vernier Rheostats	.69
Trista Standard or WD11 Bakelite Sockets	.48
Federal Standard or UV199 Sockets	.79
Trista Open Circuit Telephone Jack	.27
Trista Double Circuit Telephone Jack	.32
Trista Single Circuit Filament Control Jack	.35
Trista Double Circuit Filament Control Jack	.39
Trista Standard Phone Tip Plug	.32
Carter Two-way Phone Tip Plug	.72
Trista Switch Levers Adjustable Radius	.14
Trista Phone Tip Binding Posts	.03
Trista Rubber Tip Binding Posts	.04
Trista Switch Contact Points or Stops	.09
Trista 3 inch Composition Dials	.23
Dayton 3 inch Bakelite Dials	.39
Copperweld Aerial Wire (per 100 ft. package)	.48
Phone & Grid Condensers all cap	.08
Nickle Plated Pocket Voltmeters 0 to 50 volts	1.12

All merchandise guaranteed as advertised or money refunded. Include postage. No C.O.D. shipments without deposit.  
**TRI STATE RADIO SALES COMPANY**  
 214 Victoria Bldg. St. Louis, Mo.

## NAZELEY'S

# PORLENA

The Newest and Most Practical Development in Aerial Loops

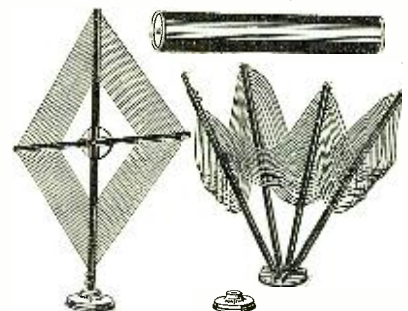

Collapsible and Portable Loop Aerial Automatically Opens and closes; instantly set up or Packed. Complete with Morocco Finished Case **\$6.50**  
**J. NAZELEY CO., Manufacturers**  
 571 Hudson Street, NEW YORK CITY, N. Y.

## ONE THOUSAND AGENTS WANTED

We want one thousand agents to sell subscriptions to RADIO NEWS, SCIENCE AND INVENTION and PRACTICAL ELECTRICIAN. We will pay a generous commission for this work and help you in every way. Our three publications are leaders in their fields, ready sellers and this is an offer well worth your while. A few spare hours a day will bring you a handsome return. Write regarding our proposition at once and be the first one to get started in your vicinity.

**Experimenter Publishing Co.**  
 HERBERT H. FOSTER, Sales Manager  
 53 Park Place New York

The alternator compensating condenser 2 may be done away with altogether and a suitable setting of the condenser 7 made to fulfill the former's purpose.

Figs. 4 and 5 represent a photograph of a model capable of giving a trebled frequency output of 12 to 15 kilowatts at 100,000 cycles starting from an alternator frequency of 33,000 cycles. The magnetic circuit is made up of only 500 crown-shaped 0.05 to 0.06 mm. sheets having inner and outer diameters of 69 and 89 millimeters respectively. The total weight of the magnetic circuit is but about 500 grammes (1 lb.). The instrument comprises 30 turns of bare copper strip 1MM x 10MM easily allowing a current of 80 amperes which produces the extreme core saturation ( $H = 175$ ). The apparent power at the terminals of the instrument is then 60 KW. The losses within the multiplier are of the order of 1,500 watts.

It may be shown easily that the power of an instrument increases as the cube of its dimensions. Therefore, in a unit of 120 to 150 kilowatts at 100,000 cycles, the outer diameter of the core laminations would be only 18 centimeters.

Power may also be drawn from the higher harmonics of 165,000, 230,000 and 300,000 cycles per second.

We may therefore conclude that there no longer exists any limit to the frequency of the currents which it is possible to industrially obtain without resorting to the arc or to the three-electrode valve.

Translated from "RADIO-ELECTRICITY."

### Continuous Wave and Radiophone Transmitters

(Continued from page 558)

get maximum output from our tube when there is such a wide discrepancy between the generator impedance and the load impedance. It is therefore necessary to use some device whereby we can *adapt* the load impedance to the generator impedance. Such a device is a transformer with a definite step-up ratio. It is shown in the study of transformers that a resistance in the primary side of a transformer is equivalent to a certain resistance in the secondary side of the transformer. If the step-up ratio is say 10, a resistance of 10 ohms in the primary is equal to 10 times the ratio squared in the secondary, that is, it is equal to 1000 ohms in the secondary. If the ratio is 20, then 10 ohms in the primary is equivalent to 10 times 20 squared, or 4000 ohms in the secondary. In other words by means of a transformer suitably proportioned we can make a low resistance in the primary equivalent to a high resistance in the secondary.

This immediately gives us a method for securing maximum output from our tubes in spite of the fact that the tube has an impedance of 5000 ohms and our antenna say only 10 ohms. We design a transformer so that the primary or low side is connected to the antenna, while the secondary or high side is connected to the tube. By suitably proportioning the turns we can make the ratio such that the antenna resistance of 10 ohms in the primary is equivalent to 5000 ohms in the secondary. In this way we have adapted our antenna to the tube and thus secured maximum output at maximum efficiency. Now there are two ways in which this is done: (1) by proper proportioning of the turns, and (2) by variation of the coupling between primary and secondary. Thus by altering the coupling we in effect adapt the antenna to the tube to get maximum output, and when we alter the antenna



## LOUD SPEAKER

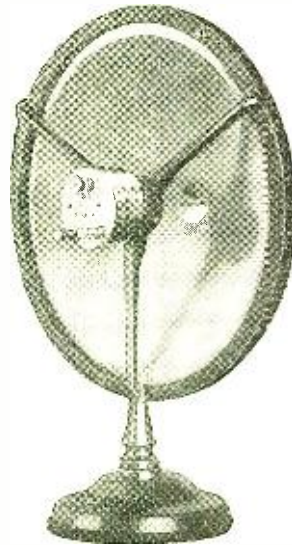

Price  
**\$22.00**

### A Combination of Efficiency and Beauty

The Pathé Loud Speaker is unexcelled for its clarity and faithfulness of reproduction. In the large sized diaphragm lies the secret. The music is thrown directly from the diaphragm into the air in all directions. That choked and distorted sound is eliminated. Only a beautiful pleasing tone is heard.

The beauty of the Pathé Loud Speaker has called for untold praise. Its design shows excellent taste. Its elegant finish of delicate Pompeian Green blends with the surroundings of any room. Not big, not ugly, just as sweet as the music it faithfully reproduces.

Jobbers and Dealers write for Special Proposition.

**Pathé Phonograph and Radio Corp.**  
20 Grand Avenue, Brooklyn, N. Y.

**LEARN ELECTRICITY IN 3 MONTHS**

Now is the time to learn electricity, the big-paying profession. You will be ready to step right into a fine electrical position the day you finish your training. Learn on \$200,000 equipment. Coyne men get the best jobs.

**\$150 to \$400 a month**

employment department and life scholarship in the great Coyne School. Write today for details of our great offer.

Write Today **Coyne**

Trade and Engineering Schools  
300-1310 W. Harrison St.,  
Dept. 59-48, Chicago, Ill.

**WHY PAY MORE?**

**RADIO SERVICE BATTERY**

6 Volt	\$14.00
80-100 Amps	
6 Volts	\$16.00
100-120 Amps	

**2 YEAR GUARANTEE**  
**INDESTRUCTIBLE RUBBER CASE**

Service Batteries are manufactured for Radio only. by battery men who know radio. We guarantee Service Batteries to

**IMPROVE RECEPTION**

If after 30 days' trial you do not find this to be the best battery value on the market today, return to us and we will gladly Refund Your Money. Shipped by express C.O.D. day order is received. 5% Discount for Cash with Order.

**SERVICE BATTERY CO.**  
704 East 102nd St., Cleveland, Ohio

# Morrison



*Loud Speaker*

## Deep Notes Sweet Notes

both come equally true-toned and full-volumed over your Radio when your phonograph or horn has a Morrison Loud Speaker.

### Perfect Reproduction

The real joy of radio is assured you. No rattle or vibration, no metallic harshness, even when the amplification is extreme.

Anyone can attach the Morrison Loud Speaker to the tone arm of a phonograph in a moment's time. A slight adjustment of the knob or dial on the rear adjusts the tone, soft or loud, just as you wish. There is nothing else to do—nothing to get out of order—you just begin to really enjoy radio when you use the Morrison Loud Speaker.

Adaptable for use on any bulb set with one or more stages of amplification.

Sold on a money-back guarantee. Price, complete with five-foot cord, nickel finish,

**\$10.00**

Order from your dealer or direct from us. Send today for beautifully illustrated catalogue—it is free.

### Dealers

If you are interested in one of the fastest-selling Radio units on the market, wire or write at once for our proposition—it is interesting.

## Morrison Laboratories, Inc.

339 Jefferson Avenue, East  
Detroit, Mich.

### MAKE YOUR OWN "B" STORAGE BATTERY

At a cost of \$1.60 for materials for a 15-cell Battery will give 35 Volts and last for years.

Full directions including 4 Blue Prints showing how to construct a practical storage B Battery—also showing how to make a Rectifier to recharge battery from the Hoese Electric Line at a cost of less than one cent. Mailed to any address on receipt of \$1.

A. M. MORTON

3064 West 103d St., Cleveland, Ohio

## How to Invent

Learn at Home in your spare time.

Develop your inventive ability! A single idea, properly developed, can make you independent for life. Little inventions have made countless others wealthy. **BOOK FREE** Tells how YOU can learn the science of invention. Spare-time study. 15 famous inventors help you. Every phase of Inventive Science taught. Write for free book today. No connection with patent attorneys. **BUREAU OF INVENTIVE SCIENCE** Rochester, N. Y. 331 Wisner Bldg.

tap on the antenna coil we do two things. We alter the number or turns in the primary of the plate-antenna transformer, and thus alter the ratio and help to adapt the antenna to the tube for maximum output, and at the same time we are tuning the antenna circuit to the wave-length of transmission.

For amateur work the following constants have been found to be most suitable. Inasmuch as the actual output current is not very great on such low power equipment it is perfectly good practice to use solid wire. If Litzendraht wire is handy so much the better, copper ribbon may likewise be used, though it is not essential and is more expensive and therefore better left for the higher power sets. Any size wire from No. 14 to No. 18 D.C.C. will be suitable for these coils, in fact annunciator wire will do very well. The antenna coil should be wound on an insulating form, hard rubber, formica or bakelite will do very well, the actual insulating material used depending upon the state of your finances and how fine you want your set to look, using 5" to 6" diameter tubes (5½" will do very nicely) with 1/16 walls. Twenty-five turns of wire are all that are needed, tapped every two turns, so that a fairly fine adjustment of the wave length will be possible.

The plate coil should be wound on a similar insulating form having a diameter of about 4½" to 5", and wound with 50 turns of bell wire. This coil is coupled to the antenna coil and the coupling should be variable. By varying the coupling of plate coil to antenna coil we have a means of varying the mutual inductance between them which in effect is a means of adapting the antenna load to the resistance of the tube.

The coupling of the plate coil to the antenna may be accomplished in a number of ways, but the following two will be found to be both simple and effective. The first method is that shown in Fig. 2, in which the plate coil slides inside the antenna coil. The antenna coil is mounted on two very simple pieces of wood cut in the shape illustrated herewith, and the taps brought out on a terminal block which is preferably made of the same material as the tube. The plate coil has two end blocks of wood W fastened to the coil ends and a rod screwed in to the end of which an inexpensive knob is fastened. Coupling changes are made by sliding the plate coil in and out of the antenna coil by means of the knob. The alternative arrangement suggested is to wind the plate coil on a form somewhat similar to a variometer rotor, with regular shaft, as in Fig. 3. Coupling between plate and antenna may then be varied by rotating the plate coil inside of the antenna coil.

The other constants of the set, referring back to Fig. 1, are as follows: The antenna series condenser, Ca, is 0.0003 microfarads, while the grid condenser Cg is 0.002 microfarads capacity. These should be insulated with mica and need not be variable. The grid leak Rg is 5000 ohms, and in the experimental set-up here used a Ward Leonard unit was employed. It is preferable to use straight wire wound resistance units to any other type. Across the source of plate voltage supply a high capacity should be used to by-pass any radio frequency which may flow that way, and especially in the case of a generator, this should be used to smooth out any commutator hum which may be present. A good value to employ is about 1 microfarad, and for voltages up to 500 volts the Western Electric No. 21A or similar condensers are quite good.

The method of tuning the set is very simple. Set the antenna tap at what you consider the approximate setting for your wave-length, or if this is not known, set it at the center of the antenna coil, and vary the coupling of plate coil to antenna, and note

*The choice of foremost Engineers for over 17 years.*

Sold by all dealers

**BRACH**  
VACUUM  
**RADIO PROTECTOR**

Approved by the National Board of Fire Underwriters

Ask YOUR Insurance Agent

L. S. BRACH MFG. CO., Newark, New Jersey

---

**SOLDERALL**  
Metal in Paste Form

Handy Tube: 25¢  
Every Electrical Connection Needs Solderall for Perfect Reception  
The Only Convenient Metal Solder

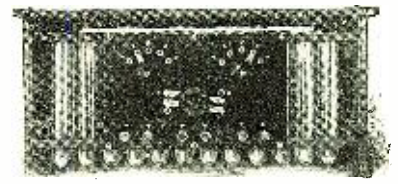

100 VOLT PANEL (New Type)

## KICO Storage "B" Batteries Give Long Service at Low Cost.

Alkaline type, will not sulphate or buckle. Life unlimited. Not harmed by short-circuiting, over-charging, or standing idle. Panel switches afford single cell variations. Easily re-charged from any 110-volt A.C. line by means of small home rectifier. One charge lasts three to six months in detector plate circuit.

Prices	16 cell	22 volt	Plain	(With Panels)
without rectifier	24 cell	32 volt	\$ 5.50	
	24 cell	32 volt	\$ 7.25	\$11.75
	26 cell	48 volt	\$ 9.50	\$14.00
	30 cell	68 volt	\$12.50	\$17.00
	73 cell	100 volt	\$17.50	\$22.50
	108 cell	145 volt	\$23.50	\$25.50
	Mounted rectifier		\$ 1.00	
	Mounted rectifier		\$ 2.50	

### Satisfaction Guaranteed

All batteries are sold with the privilege of receiving your money back if not satisfied within a 30 day trial. Write for full information on "A" and "B" Batteries.

## Kimley Electric Company, Inc.

2665 Main Street

Buffalo, N. Y.

**ELECTRIC SOLDERING IRON**

EVERY RADIO FAN has been looking for this iron for both radio and home use. Operates on A. C. or D. C. current.

**228**

GUARANTEED one year. Sent anywhere in U.S. or Canada Parcel Post prepaid on receipt of money order for \$2.28.

FANS Send 2c stamp for our list of RADIO BARGAINS

**RADIO BARGAINS**

17 N. LA SALLE ST. - CHICAGO

## ARE YOU SELF-CONSCIOUS?

Embarrassed in company, lacking in self-control? Let me tell you how you can overcome these troubles. M. VERITAS, 1400 Broadway, New York City



the reading on the antenna ammeter. If possible an ammeter should be used for tuning, but if this is not available, use a small lamp and use the brilliancy of the light as an indication of resonance. Note reading of the ammeter or brilliancy of lamp at the best setting. Now move antenna tap to the next one either above or below last one and again vary coupling until best results are obtained. Do this until you secure maximum radiation current at your required wave-length. It is often desirable to use meters wherever possible. It is often found that a larger plate current, at a particular adjustment, will give a high antenna current, as opposed to a slightly smaller antenna current and lower plate current at another adjustment. The larger antenna current is not necessarily the best operating point, for the efficiency may be much smaller than at the slightly lower radiation. The amateur should watch out for this.

The most important meters to use are: (1) a radiation ammeter in the antenna for indicating when resonance or maximum radiation is had, (2) always use a filament voltmeter in preference to an ammeter and keep the voltage constant as this will insure maximum life for your tubes, and (3) a plate milliammeter.

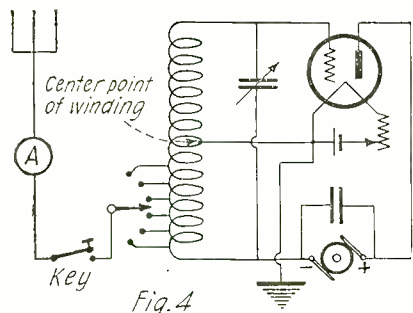

A Practical Circuit for a Low-Power C.W. Transmitter.

For those who desire to experiment around a bit before deciding on a particular circuit, the one shown in Fig. 4 is suggested as worthy of a trial. It is a very simple one and requires little apparatus. A single coil is used wound on a 4" form, and has about 40 to 50 turns of annunciator wire. Half of this coil, it will be observed, is the antenna coil, while the other half is the grid coil. The antenna coil is part of the plate coil, hence the plate coil is tapped every two or three turns. A variable condenser, having a maximum capacity of 0.0005 to 0.0007 microfarads is used across the ends of the coil. The key may be placed directly in the antenna circuit. No grid leak or condenser is used. As in the other circuit the plate source of supply should be shunted by a by-pass condenser.

The above two circuits will do pretty well for a start on low power sets and working around with them will teach the amateur considerably more than he can learn by reading solely. In the next article the subject of higher power oscillating circuits will be dealt with together with the question of securing power supply by rectification of alternating currents.

9AHN

QRA, 9AHN, Frank Kinch, 315 Cottage Grove Avenue, Cedar Rapids, Iowa. Appreciate QSL's of my 1 1/2-K. W. spark.

NOTICE OF CHANGE

Station 4HV has given up the old rock crusher. A 10-watt C.W. set is now in operation. QSL's will be appreciated.

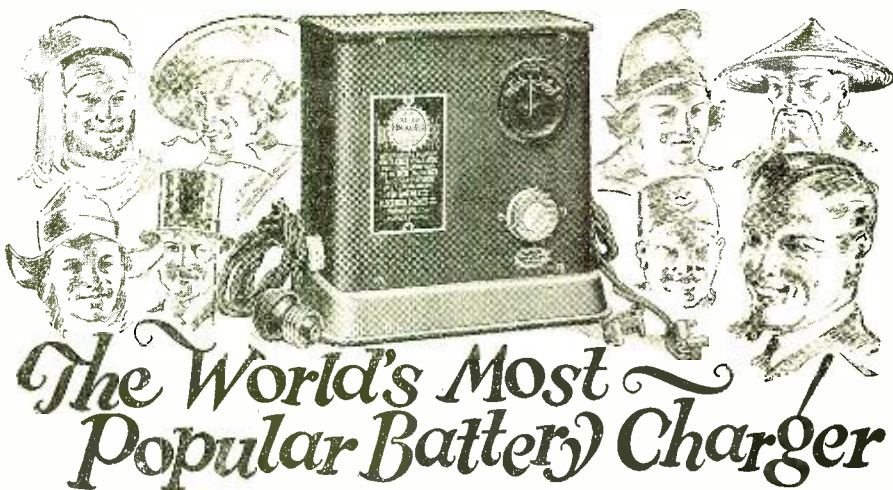

Nothing speaks so eloquently of HOMCHARGER satisfaction as the fact that thru sheer merit alone it has become the standard by which all other battery chargers are judged. Over 125,000 HOMCHARGERS already in use offer the most convincing proof that it is the most efficient, economical and fool-proof battery charger at any price.

A NEW TRADE-MARK FOR A TRIED AND PROVEN PRODUCT

Its phenomenal success has led to the introduction of many inferior and make-shift imitations. To insure our reputation and protect the buying public against substitution, the Radio De Luxe HOMCHARGER henceforth will be sold under a new Trade-Mark, viz.:



Retaining the same fundamentally correct operating principle and beautiful appearance of our Radio De Luxe model, it is a step nearer ultimate perfection through adoption of several construction refinements dictated by the policy of Progress.

HOMCHARGER'S 10 POINTS OF SUPERIORITY

1. Simple—Only one moving and wearing part, replaceable after thousands of hours use for \$1.00. Will last a lifetime.
2. Efficient—Uses less than one-half the current of any bulb or liquid type rectifier. Will charge any radio or automobile battery for a nickel.
3. Quick—Its high charging rate of 7 amperes eliminates long waiting for battery to become charged. Will charge any "A" or "B" battery over night, or three times as fast as a 2-ampere machine.
4. Clean—No expensive bulbs to break or acids to spill or replace. No acid fumes. Charges without muss, fuss or bother.
5. Dependable—Tungsten contacts insure continuous operation—prevent sticking and stopping.
6. Fool-Proof—Can be operated by anyone. Attach to lamp socket and connect battery either way, it will always charge. High-grade ammeter eliminates guess work.
7. Safe—No danger of shock or fire. Tested and approved by Fire Insurance Underwriters everywhere. Gives tapering charge—will not overheat or injure battery.
8. Beautiful—Mahogany and Gold Finish.
9. Unqualifiedly Guaranteed.
10. Popularly Priced—Retail at \$18.50 complete (\$22.00 Canada). No extras to buy. Sold by all dealers.

3. Quick—Its high charging rate of 7 amperes eliminates long waiting for battery to become charged. Will charge any "A" or "B" battery over night, or three times as fast as a 2-ampere machine.
4. Clean—No expensive bulbs to break or acids to spill or replace. No acid fumes. Charges without muss, fuss or bother.
5. Dependable—Tungsten contacts insure continuous operation—prevent sticking and stopping.
6. Fool-Proof—Can be operated by anyone. Attach to lamp socket and connect battery either way, it will always charge. High-grade ammeter eliminates guess work.
7. Safe—No danger of shock or fire. Tested and approved by Fire Insurance Underwriters everywhere. Gives tapering charge—will not overheat or injure battery.
8. Beautiful—Mahogany and Gold Finish.
9. Unqualifiedly Guaranteed.
10. Popularly Priced—Retail at \$18.50 complete (\$22.00 Canada). No extras to buy. Sold by all dealers.

FREE BROADCASTING LIST. Send today for Free List of Broadcasting Stations, and Circular Describing the Gold Seal Homcharger.

DEALERS! JOBBERS!

GOLD SEAL HOMCHARGERS will outsell any other radio device this season. "GOLD SEAL Business Builders" illustrates many attractive sales helps and explains how we are prepared to cooperate with the Trade in making this a "HOMCHARGER Year." Send for your copy and Trade Discounts, TODAY.

Insist on the GOLD SEAL



It's your protection against substitution. When buying order by name and verify by the GOLD SEAL, which appears on the carton as well as the nameplate.

The Automatic Electrical Devices Co., 118 West Third St., Cincinnati, O.

Largest Manufacturers of Vibrating Rectifiers in the World

**PRECISION RESISTANCE UNIT**

DAVEN RADIO CO.

Insure Clear and silent operation with Fixed Resistances. Correct resistances of known value must be used for clear, distortionless reception. Each Unit individually calibrated. Our interesting discount schedule mailed to Jobbers on request.

DAVEN RADIO CO.  
144 Bleecker Street, Newark, N. J.

**HEAR DISTANT POINTS ON CRYSTAL SET**

With ANCHOR-ITE. THE MILLION DOLLAR CRYSTAL. Signal and reception the most distinct ever heard on a crystal. Each Anchor-ite Crystal is concert tested and guaranteed to give best results. Send 25c and a mounted crystal will be sent post-paid.

DEALERS WRITE FOR EXCLUSIVE SALES RIGHTS IN YOUR CITY

Sole Distributors **THE ANCHOR CO.**  
420 Wood St., Pittsburgh, Pa. Dealers Wanted

**FORMAN & Co.,**  
**Broadcasting**  
*To The Trade*  
**The Merits of Our**



**RADIO ACCESSORIES**



Mica Condensers of all capacities. TESTED and GUARANTEED accurate to rated capacity. List price .....25c



TESTED AND GUARANTEED

GALENA **I** there were any  
 PYRITES **F** better we would  
 SILICON **F** make them.  
 Packed in cotton in individual boxes.  
 List Price .....10c

Paper Condensers, Mounted Crystals, Binding Posts, Switch Levers, Detectors, Sliders, Contact Points, Aluminum Sockets

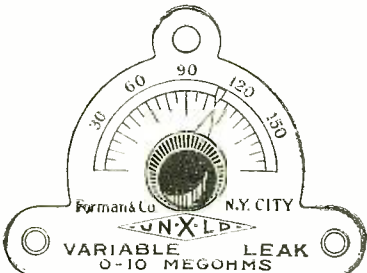

This is the Grid Leak recommended by the Editor of the Sun-Globe Data Sheets of August 18th, 1923.

Variable Grid Leak. 0-10 Meg. Specially formed tension contact. Permanent, unregretted Grid Line—with Composition, tapered knob. List price .....25c

**WHOLESALE ONLY**

WRITE TO-DAY FOR TRADE DISCOUNTS.  
**FORMAN & CO.**  
 Manufacturers  
 366 Greenwich Street, New York

**Radio Fans**  
**High Carbon Tool Steel Forceps**  
**Only \$1.00** Clamp these self-locking nickel plated forceps on each tap you take in winding inductances of any kind. Pliers won't stay clamped—these forceps grip tight. Hundreds uses in building any set. An extra hand wherever needed. Send for it today. We'll send it postpaid on receipt of \$1.00. Satisfaction guaranteed or money back.  
**C. E. CARSON** Dept. 211 1001 Washington Blvd. Chicago

**HOW TO BUILD HAZELTINE'S**  
 50¢ Send 50 cents—now—for book telling how to construct a long distance receiver using the Neutrodyne circuit.  
**F. A. D. ANDREA, INC.**  
 1581A Jerome Ave., N. Y. City  
**NEUTRODYNE CIRCUIT RECEIVER**

**A One-Tube Receiver That Brings Them In**

(Continued from page 533)

and received an awful howl in the phones and decided that the tube was spilling over. This is a negative charge that accumulates on the grid and leaks off in minute discharges which can be governed by a grid leak. These charges are negative so we can assume that the grid is negative most of the time and that an impressed E.M.F. on the grid circuit would tend to build to infinity during the time the grid was negative. This seems correct, as only a short aerial is required.

As the wave-length is halved, the amplification is squared by virtue of the increased frequency as compared with the rate of leakage. This may account for the marked results on the shorter wave bands.

This circuit is the result of a year's experimental work on the Ultra Regenerator which was originally published in the "Boston Globe" under the date of August 22, 1922. The work was carried on at radio station 1XP.

**High Frequency Resistance**

(Continued from page 551)

Hence in desert regions the average humidity is, say, 25 per cent, showing that the atmosphere has much less water than required to saturate it; or during a dense fog, a humidity of 96 per cent shows that the air is nearly saturated.

Normal room temperatures average about 65 per cent as, say a reading where temperature of 38° F. shows 2 grams of water per cubic foot of air; or 42.5 per cent at 72° F., at which temperature this humidity results for 4.45 grams of water per cubic foot of air. The relative humidity depends upon the temperature; the pressure has nothing to do with it. Hence we find that with different temperatures from day to day we have different quantities of water present in the air we breathe, and it is a logical conclusion that materials having an affinity for moisture are greatly affected by changes of humidity of the atmosphere, and insulating properties of substances are changed to a considerable extent because of it. This is true of inductor coils having fibre insulation and insulation generally, and before investigating a coil's actual behavior, we will examine the composition of insulation coverings of cotton, silk and enamel.

**INSULATION**

Previously to 1838, Prof. Joseph Henry had performed his famous experiments in electromagnetic induction, employing for his coil windings "copper plate . . . well covered with two coatings of silk" and also "wire . . . covered with cotton thread saturated with bees' wax, and between spires (layers) a coating of silk." Insulation was carefully attended to in all his work. Now we have standard commercial magnet wire of various gauges and generally insulated with cotton, silk or enamel, with possibly a combination of these. Cotton insulation is made by first employing coarse cotton threads containing 40 to 200 cotton fibres twisted together, several of these parallel threads being wrapped at the same time about the wire gives a "single cotton" covering; and a similar winding, generally in the

**You Know These HEADBANDS**

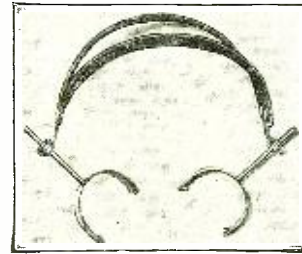

Simple friction slide adjustment. Most satisfactory on the market. No thumb screws to bother with or to catch in the hair. Two yoke sizes fit any 'phones. Bands covered in Black or Khaki webbing. Prompt deliveries on any quantity.

\$500,000.00 worth of special and automatic machinery assures quantity output and guaranteed delivery for manufacturers and dealers on any radio equipment.

Submit sample of product. Write for prices.

**THE AUTOYRE CO.**  
 OAKVILLE, CONN.

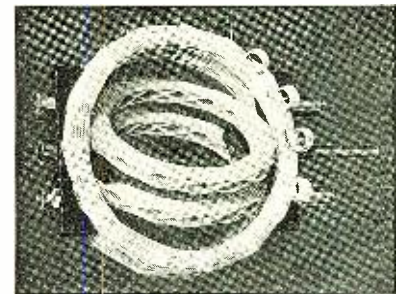

**R. M. C. Diamond Weave Variocoupler and Variometer**

Due to diamond weave construction and the fact that 7/8 of the total area of windings are supported in mid-air, capacity and dielectric losses are reduced to a minimum in R. M. C. Variometers and Variocouplers. The rotor is continuously variable. These products may be used in any circuit where a high grade coupler or variometer is required. All metal parts are nickel-plated. Panel mounting requires very small space. Screw holes covered by 2" dial.

R. M. C. products are built for the finest sets that can be constructed.

Variocoupler .....\$4.25  
 Variometer .....\$4.25

Write for catalog of other diamond weave coils and Radio Frequency Transformer.

**THE RADIO MANUFACTURING CO.**  
 of Springfield, Massachusetts  
 Dept. A 97 Dwight St.

**Radio Fans**  
 Rejoice when using these pneumatic phone cushions. They gently hug the ears, shutting out all room noises. Fits any type headset Money back guarantee if you are not satisfied.  
**HEADPHONE CUSHION**  
 FANS List of Bargains FREE  
**RADIO BARGAINS**  
 17 N. LA SALLE ST., CHICAGO

**TELEGRAPHY**

BOTH MORSE AND WIRELESS taught thoroughly. Big salaries; tremendous demand. Oldest, largest school. Endorsed by Telegraph, Railway, Wireless and Government officials. Expenses low—opportunities to earn large notions. Catalog from **DODGE'S INSTITUTE**, Mora Street, Valparaiso, Ind.

opposite direction, placed over this produces a "double" cotton covering of considerable thickness.

Silk insulation is similar except that it is more compact due to the extreme length and straightness of silk fibres. A rough microscopic sketch of the appearance of the two is shown in Fig. 3. Cotton fibres are hollow spiral cells, slightly opaque, averaging about two inches in length when formed. They are flattened somewhat and break up into short lengths in forming the threads. Silk, being produced by secretions issuing from the worm's spinnerets, is a solid transparent rod of great length, having some imperfections such as indentations, projections, and rather irregular cross section due probably to muscular contractions of the orifice during formation.

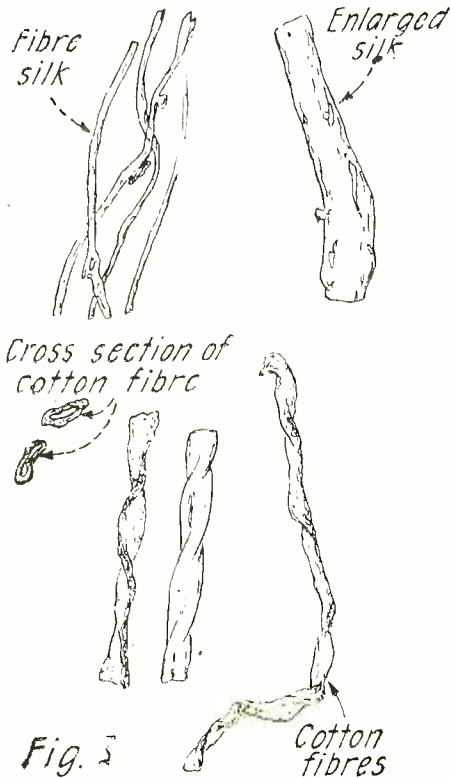

Fig. 3  
A Microscopic Sketch of Cotton and Silk Fibres Showing Their Formation. Note That the Cotton Fibres Are Hollow.

Numerous samples of cotton and silk were removed from new wires used in the construction of the coils tested. These samples of fibre were shredded and single strands and fibres selected for microscopic study. The influence of moisture was carefully observed; also their structure by suspending upon a drop of cedar oil. Cotton fibres, being short and less regular, seem to be rapidly wetted by moisture, and long fibres placed in dyed liquids are wetted thoroughly after about one hour, taking water into their interior through breaks in the cell wall or by the common process of osmosis. After several hours the process stops; and when so wetted, the fibre gives up its moisture very slowly, requiring 10 hours or more for the suspended dye to begin depositing on the cell wall's interior surface. Heating slightly or circulating of air over them hastens evaporation from the saturated fibre.

Although cotton fibres are never actually submerged when employed in insulation, there are periods when water is actually deposited upon the coil surface as is the case when a sudden change of temperature takes place. The coil being cold, coming into contact with warmer air, chills the atmosphere near the surface, causing it to drop moisture there. This is rapidly absorbed by cotton, and through capillarity spreads throughout the winding's insulation. Hence moisture is



## The Improved MIRACO Gets 'em over 1500 Miles Away

Model K  
(SHOWN ABOVE)

\$29.50

It is a two-tube outfit consisting of one stage of tuned impedance radio-frequency amplification with a tuner and vacuum tube detector. This radio-frequency receiver amplifies before it detects, eliminates interference to a marked degree and has much more volume than most one-tube sets.

Model MW  
(SHOWN BELOW)

\$54.50

The Model MW consists of the same high-grade units as our Model K, with the addition of a two step audio-frequency amplifier in a single beautifully finished solid mahogany cabinet. It is a four-tube set, comprising one stage of tuned impedance radio-frequency amplification, detector and two stages of audio-frequency.

Just like the sweet, mellow tones of a flute or violin floating in from afar out on a lake—that's the way concerts come in through MIRACO receivers—and—  
Not only from the nearby stations either. For our users tell us that Cincinnati hears Frisco, Denver hears Schenectady, New York hears Havana! Scores of long-distance records were made on these instruments last year so, with the many new refinements incorporated, the results obtainable will be far better now than ever.

### HIGHEST QUALITY AT LOWEST PRICE

When the radio craze swept the country like a storm late in 1921, MIRACO was one of the first real successful sets to be placed on the market. Highest quality at the lowest price has always been our keynote, and the thousands of sets now in use all over the world are a fitting tribute to Miraco's excellent performance. Many new improvements have just been made in the MIRACO Models K and MW, such as new sockets resting on shock absorbing pads is a refinement found only in the most expensive and elaborate sets. Improved rheostats with multiple resistance windings makes it possible to use any type of tubes and a new aluminum shield prevents annoying body effects.

The cabinet is of solid mahogany, workmanship throughout is the finest while its operation is extremely simple yet always dependable.

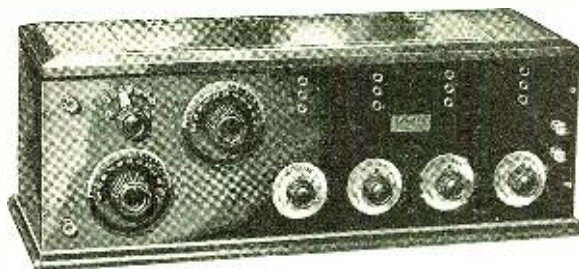

Write for our new bulletin TODAY

DEALERS — JOBBERS  
Write for proposition quickly.

AGENTS  
There's still some territory open—write or wire.

THE MIDWEST RADIO CO. 804 MAIN STREET CINCINNATI, OHIO

Unequaled  
Clearness  
Through  
New  
Magnetic  
Principle of  
Construction.

Circular  
on request.

**Moss-Schury Mfg. Co., Inc.**  
Radio Division  
2011-2015 Franklin St., Detroit, U.S.A.  
Manufacturers of precision electrical devices

### HYGRADE SPECIALS

- 200 ft. 7 strand No. 22 Copper aerial wire...\$1.25
- Morse Eureka Test Clips, per dozen..... .50
- Skinderviken Transmitter Buttons..... .95
- No. 763 Eveready 22½ V. Variable B. Bat... 1.25
- No. 766 Eveready 22½ V. Variable B. Bat... 1.98
- No. 767 Eveready 45 V. Variable B. Battery... 3.98
- 2000 Ohm Mirdock No. 56 Head Sets..... 3.50
- 3000 Ohm Mirdock No. 56 Head Sets..... 4.25
- Federal or Brandes Head Sets Complete... 5.50
- Dictograph 3000 Ohm Head Sets..... 5.98
- Fada or Framingham Rheostats..... .65
- Acme Amplifying Transformers (new type)... 3.75
- Acme R. F. Transformers, Types R2—R3—R4 3.98
- 6 Volt Marko Storage Batteries..... 8.95
- Fireco (Bull Dog Grip) Phone Plugs..... .75
- Federal Amplifying Transformers..... 4.75
- 23 Plate Var. Cond. Bakelite Ends..... 1.49
- 43 Plate Var. Cond. Bakelite Ends..... 1.95
- No. 164A Fada Neutrodon Condenser..... .98
- No. 163A Fada Neutroformer..... 6.49
- No. 165A Fada Hazeltine Parts..... 21.50

All orders must include Parcel Post charges

**Hygrade Electrical Novelty Co.,**  
41 West 125th Street New York, N. Y.

# DUTHO

## Rechargeable Storage "B" BATTERIES

Cost You Less  
Last Longer

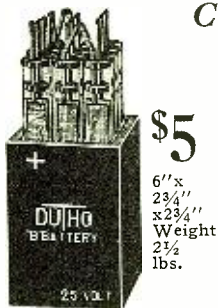

\$5

6" x 2 3/4" x 2 3/4"  
Weight 2 3/4 lbs.

DUTHO 'B' Batteries eliminate all battery noise and internal action. This prevents distortion. Heavy, individual glass tubes permit visibility at all times and make surface discharge impossible. You can see when and how to "keep them up." Condensing chamber in each cell overcomes fumes and prevents spillage.

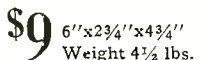

\$9

6" x 2 3/4" x 4 3/4"  
Weight 4 1/2 lbs.

DUTHO Batteries are sold DRY CHARGED, with solution in separate container. Once filled your battery is fully charged, ready for immediate use. Ordinary care in following directions will make DUTHO 'B' Batteries last indefinitely. Thousands in use today.

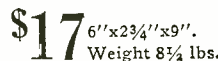
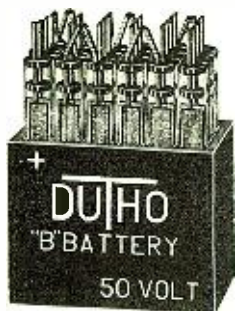

\$17

6" x 2 3/4" x 9"  
Weight 8 1/4 lbs.

Chemical Rectifier \$1.95

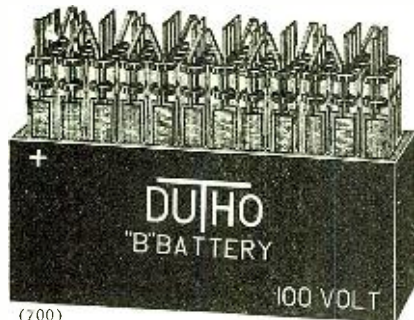

(700)

DEALERS: Write for attractive proposition.

DURKEE-THOMAS PRODUCTS CO.  
1228 Folsom Street  
San Francisco

The latest and most essential part of an efficient tube set



Variable Resistance Leaks FOR PANEL MOUNTING

Mounted on any panel in a few seconds—2 screws serving as connections behind panel. When mounted only the KNOB shows on the Panel.

Get stations you never heard before No pencil markings. Assure unbroken range of 180 degrees. Clarify signals—eliminate hissing.

Complete with either .00025 or .0005 mfd. Mica Condenser..... \$1.00 Without Condenser..... .75c

At your dealers—otherwise send purchase price and you will be supplied without further charge.

Chas. Freshman Co. Inc. Radio Condenser Products

106 Seventh Avenue

New York

readily taken up by cotton insulation and is retained in considerable quantities. The amount changing with the relative humidity of the air, or varies violently with a sudden change of temperature if such a temperature happens to be warm and humid. Silk has much better insulating properties apparently absorbing little moisture until near saturation humidities.

### RESISTANCE OF COTTON AND SILK

To obtain some idea of resistance of cotton and silk, the following experiments were performed. The actual resistance of samples was to be measured for comparison of these elements, hence all samples and mountings were of identical dimensions and were subjected to the same hygrometric conditions. As the resistances were above one million ohms, the loss of charge method was employed. The arrangement of apparatus was as shown in Fig. 4 A. C is a standard condenser having very low leakage; silver plating on selected mica, capacity 0.5 mfd. The galvanometer is a very sensitive one having ballistic coil system; K is a highly insulated key.

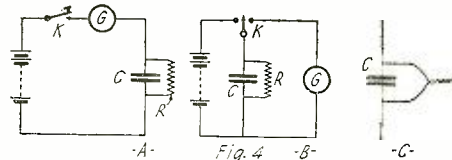

Arrangements Used to Determine the Resistance of Cotton and Silk Strands.

is shunted across the condenser C as R in the figure. The procedure was to first close the K for a period of exactly 10 seconds; it is then opened quickly and the condenser allowed to leak for t seconds, after which the key K is quickly closed, giving a second elongation in galvo G. The first deflection is due to the quantity of energy required to raise the potential of the condenser to that of the battery; the second deflection is due to the quantity of energy required to raise the voltage to its previous value. Evidently the charge required is that which has leaked through resistance R. By entering the deflections and time into the formula derived from the condenser's time constant, resistance of R is obtained. Another similar method is shown in Fig. 4B, where the deflection due to the discharge of C through G after O seconds is noted. Then the condenser is again charged and allowed to leak for t seconds, then discharged again through G giving the second deflection due to the quantity remaining in C after t seconds. The key was hand operated necessarily, and the time was measured with a seconds pendulum which operated a buzzer. A characteristic curve of the deflections with time t is shown in Fig. 5, which is for the first method in which curve A is for higher resistance than B.

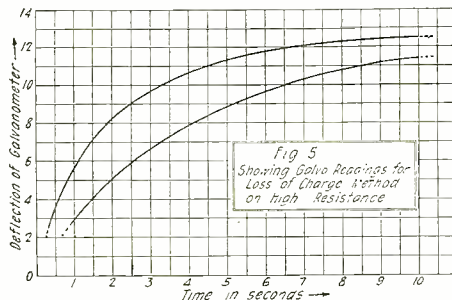

Curves Representing the Loss of Condenser Charge Through High Resistances.

Several mica strips were cut from especially selected mica, the strips being 5 cm long, 1 cm width and 0.038 millimeter thickness. A single layer of pure untreated cotton, silk, and 18 oz. canvas was folded over the strip and secured by clamps of burnished amalgamated copper to which short leads

Note: Lower Production Costs Mean Lower Prices

# DEMICAL

Plates of .032 Special Alloy Hard Aluminum

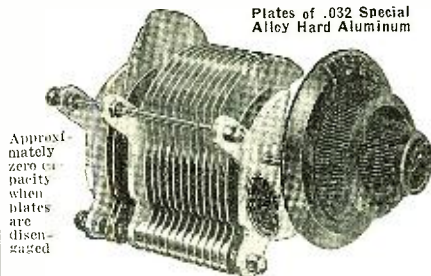

Approximately zero capacity when plates are disengaged

### VARIABLE CONDENSER

with a Straight Line Wave-length Curve  
Low Capacity Wide Wave-length Range  
Rigid Construction Prices Reduced

3 plate DEMICAL var. condenser	..... \$2.50 now \$2.00
11 plate DEMICAL var. condenser	..... 3.50 now 3.50
14 plate DEMICAL var. vernier condenser	6.50 now 5.50
23 plate DEMICAL var. condenser	..... 5.00 now 5.00
23 plate DEMICAL var. vernier condenser	8.00 now 7.00
43 plate DEMICAL var. condenser	..... 6.50 now 6.00
43 plate DEMICAL var. vernier condenser	10.00 now 8.00

Caldbeck Tool & Mfg. Co.

208-210 E. Walnut Street, Des Moines, Iowa

Something New!

## RADIO CONDENSER PLATE CLEANER



Removes accumulations between plates eliminates noises, clears reception.

Restores pep to your set.

Chemically treated to prevent lint.

Do not send stamps. Price 15c. postpaid This is one of the many up to the minute Radio parts in our Catalogue.

Send For Our Free Catalogue

Atwood Electric Co.

DEPT. A

3122 W. MADISON ST., CHICAGO, ILL.

# PATENTS

Send sketch or model today for examination and report. Record of Invention blank on which to disclose your invention and new guide book. "How to Obtain a Patent," sent free. Promptness assured. Highest references. WRITE TODAY. CLARENCE A. O'BRIEN, Registered Patent Lawyer, 342 Security Savings & Com'l Bank Bldg., directly across street from Patent Office, Washington, D. C.

## PATENTS

C. L. PARKER  
Formerly Member  
Examining Corps,  
U. S. Patent Office.  
PATENT - LAWYER  
McGill Bldg., Wash., D. C.

Patents, Trade Marks, Copyrights, Patent Litigation  
Handbook for Inventors. "Protecting, Exploiting and Selling Inventions," sent upon request.

# STAMMER

If you stammer attend no stammering school till you get my large FREE book entitled "STAMMERING, Its Origin and the Advanced Natural Method of Cure." Ask for special tuition rate and a FREE copy of "The Natural Speech Magazine." Largest and best school for stammerers in the world. Write today. The North-Western School, 2365 Grand Ave. Milwaukee, Wis.

had been attached, Fig. 6. The samples were allowed to remain exposed for several hours at various room temperatures and humidities in order to acquire their resistance in a natural way. The samples were then removed to the measuring circuit and deflection curves run off with the pendulum counts, these being for several humidities; then each was dipped into an insulating varnish known as Radio Cement after having been first dried thoroughly. The last resistance results from the exclusion of moisture and better insulation due to the varnish. The resistances given represent conductance between opposite sides of one square centimeter of the material.

(See lower table on page 551)

It seems that such fibre insulation resistance may vary 20 per cent or more when exposed to the elements, and that protection by insulating substances increases its previous best resistance 30 per cent or more, remaining practically constant thereafter.

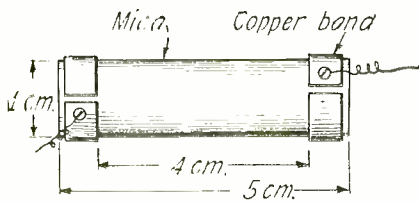

Fig. 6

The Samples of Silk and Cotton to be Tested Were Fixed on Such Strips of Mica.

**LEAKAGE BETWEEN ADJACENT TURNS AND THROUGH TUBE**

In continuous current circuits the potential between adjacent turns of a coil is very small because the negligible drop is due to a very low resistance between adjacent points upon two parallel turns, but at radio frequencies the reactance between those same points becomes effective, becoming many times greater than the copper resistance. Hence the potential becomes very much more for alternating currents than would be the case for direct currents. Poor insulation between turns permits considerable leakage there as shown in Fig. 7A. If coils are mounted upon material such as untreated pasteboard or other material having affinity for moisture, we have then leakage through the tube permitting leakage from one turn to any other turn. That this may increase a coil's resistance as much as 300 per cent will be shown by describing several experiments.

To determine the actual resistance between adjacent turns at normal room temperatures and humidities, two lengths of No. 23 double cotton covered wire were cut to a length equal to the circumference (41.45 cm.) of the standard 13.2 cm. tube used in the following tests. These were loosely twisted together along the entire length representing adjacent turns in contact. After exposure to a dry atmosphere they were measured as in Fig. 4C, then again after covering with radio cement. Enamelled 26 copper gave 179.050 megohms and was not improved by

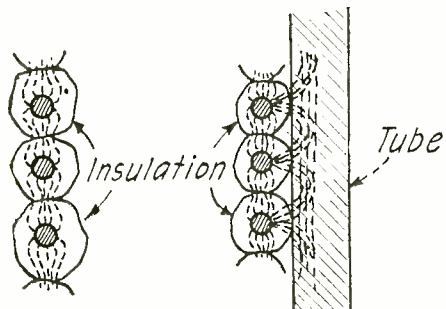

Fig. 7

A Poor Insulation Covering on the Wire or an Inferior Grade of Tubing Results in Considerable Leakage Between Turns.

# RADIOGEM

**The Dollar Radio Receiving Set**  
The Simplest Radio Outfit Made  
—Yet as Practical as the Most Expensive!

You need know absolutely nothing about wireless to operate and enjoy the RADIOGEM. It is so sturdy, so simply constructed that it is small wonder radio engineers who have tested it have pronounced the RADIOGEM a brilliant achievement. The RADIOGEM is a crystal radio receiving set for everyone at a price anyone can afford.

**Why The RADIOGEM Can Be Sold For Only \$1**

Here's the secret: The RADIOGEM Construction eliminates all unnecessary trimmings, cabinets and the like, which do not play any part in the operation of a set. You receive the RADIOGEM unassembled, together with a clearly written instruction book, which shows you how to quickly and easily construct the set, using only your hands and a scissor. The outfit comprises all the necessary wire, contact points, detector mineral, tube on which to wind the coil, etc., etc. The instruction book explains simply and completely the principles of radio and its graphic illustrations make the assembling of the RADIOGEM real fun. Remember the RADIOGEM is a proven, practical radio receiving set and will do anything the most expensive crystal set will do.

**The RADIOGEM is the Prize Winner of the Age**

Out of hundreds of radio models submitted recently in a great nation-wide contest, radio engineers, the judges, unanimously chose the RADIOGEM as the winner—the simplest radio-receiving set made! And the RADIOGEM costs you nothing to operate; no form of local electricity is required.

Sent Postage Prepaid on receipt of \$1 —stamps, money-order or check.  
**Order Your Radiogem To-day—**  
or send for Free Descriptive Circular

## DEALERS

The RADIOGEM is the wonder item of the radio age. It is storming the country, for the RADIOGEM'S price is so low everyone is able to buy one. Write immediately for full particulars before that shop across the street beats you to it.



Hear the programs of the Broadcasting Stations on the RADIOGEM

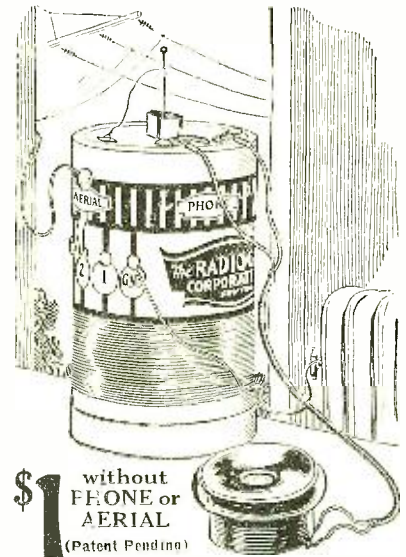

**\$1** without PHONE or AERIAL (Patent Pending)

**What They Say About RADIOGEM**

I am enclosing herewith \$1.00 to pay for the Radiogem. I had it carefully wound by our wireless operator and find that it works beautifully—fully as good as any crystal set we know of.

Radiogem received, which we assembled and were very much astonished at results obtained and the clearness and volume of tone produced.

The greatest distance I heard on one of your sets is 1900 miles, having heard WGY at Schenectady, N. Y. I think your set is the best I have ever sold at any price.

On an aerial 160 feet long and 20 high one of my customers has heard WOC and WHIR, KSD, WMC on one of your sets using a Peerless headset.

Herewith P.O.M.O. amt. \$1.00 for another "RADIOGEM." The one received is O.K. Placed about 15 ft. of picture cord under front porch and grounded to a gas meter, and heard the Sacramento Bee and Sacramento Broadcasting Union much better than with my large crystal set.

Your RADIOGEM RECEIVER is a wonder. I have received every station in Philadelphia with it much louder than with a high-priced crystal set.

Your two Radiogem sets received last night, and one was wired up for testing. WOC is about 40 miles away, and their signals could be heard with headphones on table. After they quit KYY at Chicago about 170 miles east was heard. Every word could be plainly heard here. WMC at Memphis, Tenn., could also be easily heard and understood.

We find that this set does a great deal more than you claim for it. We took WEAR on our audion set last night, this being the Baltimore American Broadcasting station, and then cut in the Radiogem and got excellent results. After the Baltimore concert was over, we continued to use the audion set and about ten o'clock were listening to WEAJ—New York—and a little later we disconnected the audion set entirely and hooked up the Radiogem, very clearly hearing both piano music and announcement of name of station and its location.

You claim a radius of 20 miles over your "Radiogem" is sometimes a possibility. You should adhere to the truth. I constructed one for my mother. Installed it with an aerial, and she listens not once in a while, but at her will, to Schenectady, Newark, New York, or Providence, R. I., and her home is Attleboro, Mass. I can't give your set too much praise.

(Names and Addresses on Request)

**JUST THE BOOK YOU WANTED**

## "Radio News" Amateurs' Handibook

Volume No. 1

Check full of radio constructive and instructive articles from cover to cover. Written by famous radio authorities in plain everyday language which everyone can understand. Sections include articles on Receiving Sets and Sundry Apparatus, Transmitters and Accessories, Radio Theory, Vacuum Tube Data, and Practical Hints for the Amateur. A book which also serves as a ready reference and should find a place in the library of every amateur. It contains 224 pages and over 375 illustrations, diagrams, and photographs, bound in a multi-colored heavy board.

On sale at all leading radio stores. If your dealer cannot supply you, pin a dollar bill to this ad and write your name and address in the margin below, and book will be forwarded to you post-paid.

**EXPERIMENTER PUBLISHING CO., INC.**

53 PARK PLACE, NEW YORK

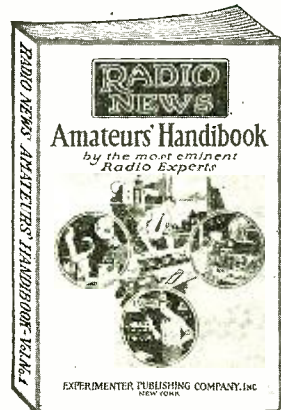

PRICE, \$1.00

Look for the Gold Cover!

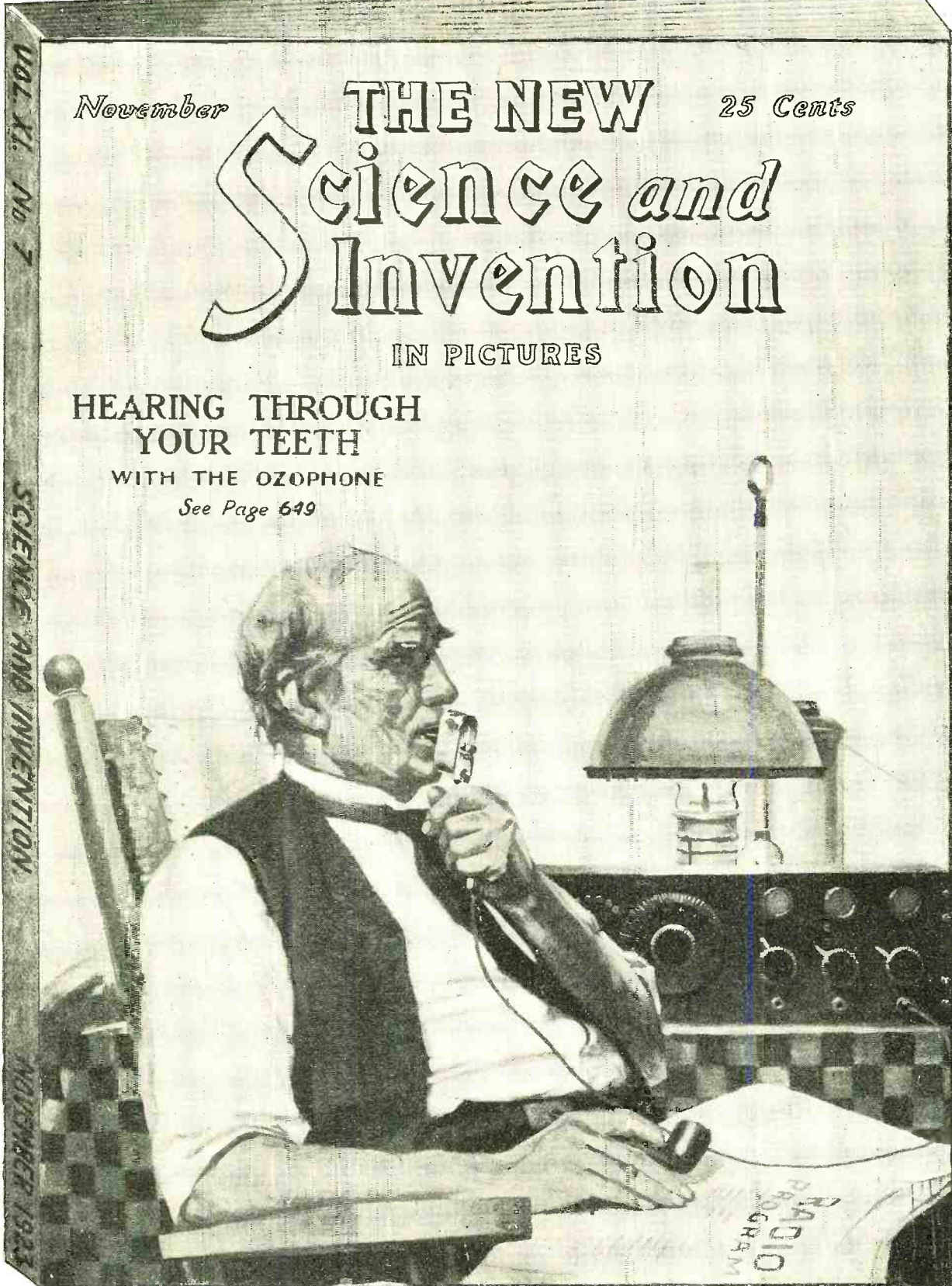

November

THE NEW

25 Cents

# Science and Invention

IN PICTURES

HEARING THROUGH YOUR TEETH

WITH THE OZOPHONE

See Page 649

The **NEW SCIENCE** and **INVENTION**. On All Newsstands October 20th

The November issue of **SCIENCE & INVENTION** will witness an important and far-reaching innovation in the magazine field. In order to give our readers greater value for their money, the November issue, and subsequent issues of **SCIENCE & INVENTION**, will contain almost three times as much matter as has been published in any previous issue.

**Over Twice As Much Radio As Ever Before**

INCIDENTALLY, **SCIENCE AND INVENTION** will appear in a new make-up which will make its reading far more fascinating and interesting than it has ever been in the past.

25c Per Copy - - \$2.50 Per Year

EXPERIMENTER PUBLISHING CO.

53 PARK PLACE, NEW YORK

varnish; cotton gave 10.28 megohms resistance, then after varnishing and air drying 24 hours it became 10.74 megohms. It was then oven baked at 150F 10 minutes, the cotton then became 3,430 megohms; and again baking for 30 minutes became 13,040 megohms between adjacent wires.

To determine leakage through untreated tubes as in Fig. 7B some coils of 21 turns each were wound on pasteboard tubing 13.2 cm. diameter. The center turn was cut to isolate the coil into two half sections according to the theorem of potential nodes. These half sections measured as in Fig. 4C gave 15.31 megohms through the cotton and pasteboard tubing. Varnishing increased it to 26.59 megohms. An identical winding of No. 23 wire on a tube previously varnished with shellac gave 6.62 megohms, and after varnishing the coil, became 42.55 megohms. Another untreated pasteboard tube having 21 turns of No. 26 enameled copper gave 1,199.2 megohms which was not improved by varnish, which shows that enameled insulation is itself a good insulator preventing leakage. Changes in enameled coils may be due to dielectric losses more than to actual leakage. Hence from these tests we find appreciable leakage through the tube.

The reader is reminded that the potentials of an inductor coil are greatest between the extremities if the coil's position is within a reasonably uniform field, but there is also a potential of considerable magnitude between any two points of the coils copper so long as they are not at right angles to the current axis. If we assume a uniform distribution of potential the center of the winding will be of zero potential node at which point the current has maximum value. However, the two half windings do not have similar potentials over their length due to the dynamic current induction, so that assuming normal potential distribution, we find the leakage between turns at high voltages is appreciable.

To show the effect of humidity upon resistance at high frequency, it is important that every other dimension be constant, hence its geometry, position in the test circuit, and frequency, were fixed and carefully checked. Moreover the humidities were to be natural and the coils allowed to acquire their characteristics in a natural way. The highly variable humidities were possible at that time of year, thanks to Valparaiso's variegated climate. Lower humidities could be artificially produced by setting coil in a chamber containing calcium chloride or a dish of sulphuric acid and pumice. The lowest humidity possible was 17 per cent, the highest 97 per cent. Humidities and quantity of water in air, temperature, etc., were read from a standard Lloyd's Hygrodeik made by Taylor.

Two coils of No. 23 D.C.C. copper were wound on treated pasteboard tubes 13.2 cm. diameter; coil A is 41 cm. long having 488 turns; coil B is 19.9 cm. long having 231 turns. The measuring circuit used for this

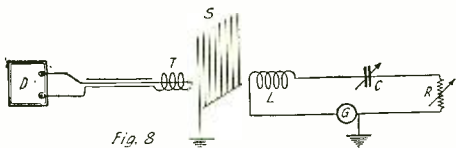
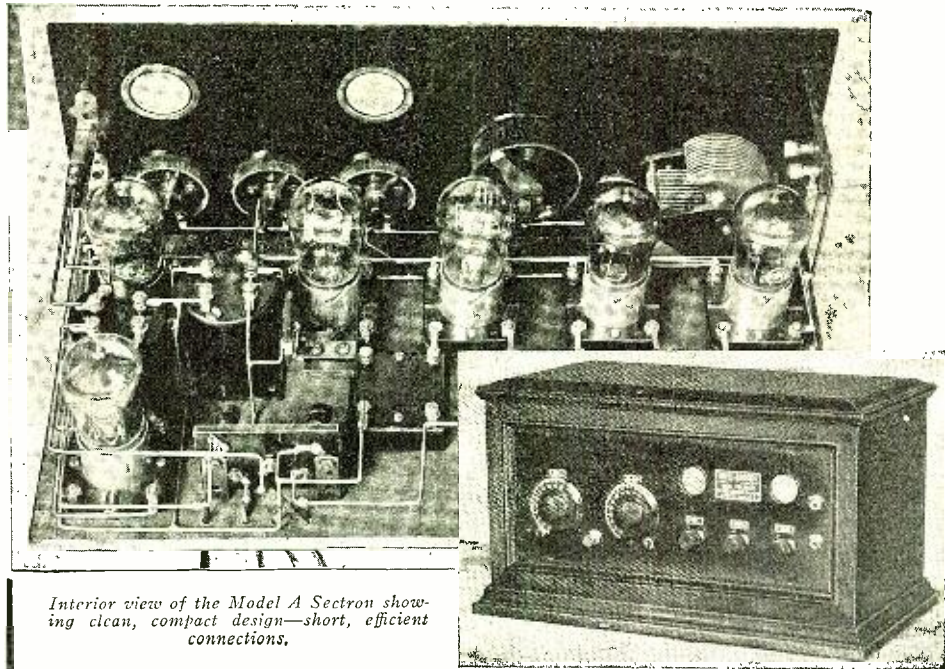

Fig. 8 Arrangement Used for Measuring the Resistance of a Coil of Wire.

and following experiments is sketched in Fig. 8 where O is a calibrated 102-watt oscillator giving continuous frequencies of 100 to 2,000 kilocycles. T is a small Litz coil of six turns coupled to the oscillator which is placed several feet distant. S is a static shielding screen—a frame 18 inches square having a fine grid of copper wire one-eighth inch apart, the upper ends are free, the lower ends being joined and grounded. The coil to be measured is at L. C is a standard variable condenser of known resistance; R a



Interior view of the Model A Sectron showing clean, compact design—short, efficient connections.

At Last! The Simple, Efficient Radio Set. No aerial required.

The outside is equally clean-cut and well designed—finished in mahogany, ebony or walnut; will grace any home.

Three stages of Radio, Detector, and two stages of Audio—selective, directional—simplicity itself in installation and operation.

# SECTRON

SIX TUBES

MANY radio lovers are waiting for radio sets to become simpler to install and operate. No need to wait longer. The Sectron meets all requirements—gets stations 1500 miles or more away—all wave-lengths from 200 to 600 meters.

It is so compact that it may be easily carried anywhere, uses only loop, no outside aerial to put up, battery connections plainly marked—no possible chance to go wrong.

After first adjustment turning of one dial will bring in all stations within range. Works with loud speaker or head phones. Except for A battery and Loop, Sectron is entirely self-contained. The last word in high grade radio workmanship. You cannot know how good a radio can be until you have heard Sectron.

## THE SECTRON RADIO COMPANY

Eastern Sales Office  
1819 Broadway, New York City



See These! Two new models will be on exhibition at the New York Radio Show. Model B—a compact, leather bound Sectron Portable—complete with batteries, loud speaker and tubes. Model C—a desk set for business men, complete, efficient and moderate in price.

1928 East 55th Street,  
Cleveland, Ohio

### COUPON

Please send me data and prices on set checked.

- Model A—de Luxe Sectron
- Model B—Portable Sectron
- Model C—Business Man's Sectron

Name .....

Address .....

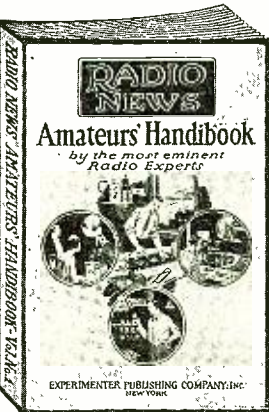

PRICE, \$1.00

JUST THE BOOK YOU WANTED

# "Radio News" Amateurs' Handbook

Volume No. 1

Check full of radio constructive and instructive articles from cover to cover. Written by foremost radio authorities, in plain everyday language which everyone can understand. Sections include articles on Receiving Sets and Sundry Apparatus, Transmitters and Accessories, Radio Theory, Vacuum Tube Data, and Practical Hints for the Amateur. A book which also serves as a ready reference and should find a place in the library of every amateur. It contains 224 pages and over 375 illustrations, diagrams, and photographs, bound in a multi-colored heavy board.

On sale at all leading radio stores. If your dealer cannot supply you, pin a dollar bill to this ad and write your name and address in the margin below, and book will be forwarded to you postpaid.

EXPERIMENTER PUBLISHING Co., INC.  
53 PARK PLACE, NEW YORK

# Sharpen Your Tuning

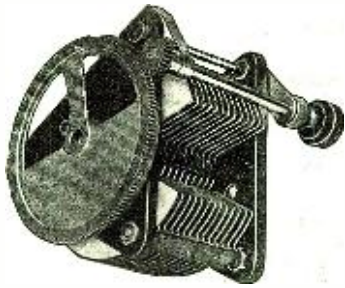

No operator of a radio receiving set need be told of the advantage of sharp precise tuning. It is not always clear, however, how this may be obtained. After a good tuning coil has been chosen look to the CONDENSER for the answer.

Here are some of the important features: Sharp tuning through low loss design using hard rubber properly placed—Heavy brass plates soldered together keeping capacity constant and greatly reducing danger of shortcircuiting—Low zero capacity giving wide wave length range—A CONTINUOUS VERNIER formed by a gear and pinion combination. Only one setting required.

Made in three sizes, 250, 500 and 1000 m.m.f. to fit every circuit. Mounted condensers are fitted with calibrated direct reading capacity dial.

Prices \$3.00 to \$8.50. Send for Educational Pamphlet "Quality Condensers" and new RADIO BULLETIN 916N.

5737

## General Radio Co.

Manufacturers of Electrical and Radio Laboratory Apparatus  
Massachusetts Avenue and Windsor Street  
CAMBRIDGE MASSACHUSETTS

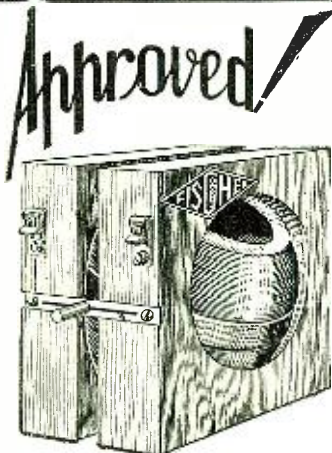

**The Champ—VARIOMETER No. 53**  
Approved as a Record Breaker by Wise Radio Fans Everywhere

Approved because it makes 600 Meters.  
Approved because perfectly constructed.  
Approved because it has a genuine mahogany stator and a kiln dried rotor.  
Approved because of Fahnestock spring clip connections and non-conductive adhesive.  
Approved because—you'll know why when you

**GET ONE FOR \$3.50**  
20 Diagrams FREE With Each

For sale at your dealer's—otherwise send the \$3.50 directly to the manufacturer and you will be supplied.

**G. H. FISCHER & CO.**

123 Liberty Street New York City

non-inductive decade resistance box. Galvanometer G is a thermo coupled current squared meter requiring 80 millamperes for full scale deflection. One terminal and the galvo case are separately grounded to prevent static disturbance which was effectually eliminated before the tests were made.

The procedure was to insert the coil of unknown resistance at L. T, S and L are given fixed positions and the test circuit tuned to resonance by adjusting capacity C. The oscillator O having been adjusted to a frequency of 200 kilocycles was then adjusted to give sufficient power to deflect the galvo to, say, 100 on the scale. Resistance in R was then added until the galvo reading fell to one-fourth its previous value as, say, 25; then resistance in R equals resistance of the test circuit containing L, G, and C, for, by Ohm's law, doubling the resistance halves the current, and one-fourth the scale on a current squared meter is half the current required for full scale if the meter follows the law sufficiently well. Hence from R, we must subtract the resistance of G and of C for that setting, the remainder being the resistance of L. After arranging the circuit, the two coils to be measured were allowed to stand for several hours in atmospheres of different humidities and temperatures. The hygrometer was then placed near the coils and carefully read when the coils were removed to the measuring circuit.

Fig. 9 shows the variation of coils A and B; each successive humidity is connected by the dotted lines; the small crosses show resistances for exposures of six hours or less; solid points show values for exposures

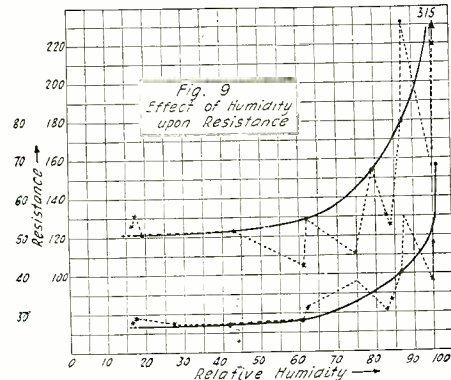

Showing the Change in Resistance in Two Particular Coils at Varying Humidities.

for 12 to 14 hours. Evidently within several hours the resistance is quite erratic, but it seems to increase very uniformly after 12-hour exposures, and that about eight hours are required for the moisture to thoroughly penetrate the winding. Also some time is first required for temperature adjustment of the coil during which the resistance may be very erratic, for on removing coils from one room to another, unsteady effects are present until the coil adopts the room temperature. The curves show little increase until a humidity of 60 per cent is reached, thereafter the increase is considerable until 90 per cent saturation is present at which coil A had increased from 121 to 195 ohms, becoming 315 ohms at 96 per cent! Coil B increased from 27 to 44 ohms at 90 per cent, then 68 at 96 per cent—all due to the effect of moisture. Silk being much better insulation shows no change until 85 per cent saturation, but its resistance falls rapidly thereafter.

The previous history of the coil insulation governs somewhat the rate of variation with humidity. It also is an important factor governing the penetrability of varnishes into insulation, which makes the change of distributed capacity vary greatly in identical coils. Penetrability of varnishes is greater in some places than at other areas, and since any change is due to the inductivity of the dielectric inserted, the percentage increase varies greatly in coils of identical geometry presumably due to the vari-



## Stromberg-Carlson Radio Head Sets

are wound a layer at a time, with insulation wrapped between each layer. This is the reason why Stromberg-Carlson Head Sets stand up under high plate voltages.

Other features of the Stromberg-Carlson Head Sets are—

The receivers are balanced as to volume—both ears get the message.

The ear caps cover the ears—excluding outside noises.

The adjustment rod telescopes and therefore does not catch the ladies' hair.

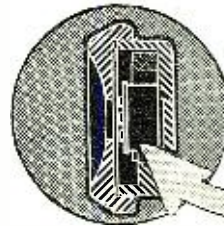

Ask Your Dealer

Stromberg-Carlson  
Telephone Mfg. Co.  
Rochester, N. Y.

## The Condenser Sensation of Modern Radio



Through the accuracy and dependability of Freshman Condensers, hook-ups and circuits have been perfected which have completely revolutionized the art of Radio Reception.

These little Storers of energy and rectifiers of Radio Current are the very heart of a well-built radio set.

The proper fixed condenser will make all the difference in the world in the reception, clarity and selectivity your set affords.

Capacity	Each	Capacity	Each
.0001	\$.35	.002	\$.40
.00015	.35	.0025	.50
.00025	.35	.003	.60
.0002	.35	.004	.75
.0003	.35	.005	.75
.00035	.35	.006	.75
.0005	.35	.008	1.00
.0006	.40	.01	1.00
.0008	.40	.015	1.50
.001	.40	.02	2.00
.0015	.40	.025	2.50

The FRESHMAN is so designed that constant equal pressure is exerted on the condenser plates over the entire area. They are the only condensers that do this and therefore the only condensers that avoid noise, which are due to variable pressure on the plates.

At your dealers, otherwise send purchase price and you will be supplied without further charge.

**Chas. Freshman Co. Inc.**  
Radio Condenser Products  
106 SEVENTH AVE., NEW YORK



able absorbing properties of cotton and silk. Some varnishes fill the insulation very quickly leaving much space open between turns, where other varnishes have low penetrative power and merely fill in around the wire, closing up open spaces but scarcely entering the insulation. By a pressure system of coil impregnation the characteristics become more uniform, particularly multi-layer coils which are very slow to acquire moisture and likewise reluctant to give it up due to the comparatively small exposed surface. The exact effect upon distributed capacity will be recalled later in a companion section.

There is great variation of humidity in almost any room or place if it is not enclosed. It may vary considerably within a few minutes and any equipment provided with untreated coils may suffer changes which may interfere with its efficiency. The writer recalls instances where the apparatus was covered with moisture which dripped off the panels to the floor as the vessel moved suddenly from one ocean current into another, which occurs frequently on ocean-going ships. The coil should be reasonably dry before applying the varnish. The following experiments were performed to obtain some idea of the resistance of insulating varnishes when dried. As before it was decided that a large variety of coils of different dimensions and type were advisable, and thirty-two were made especially for these tests. Several standard insulating compounds were to be used, and manufacturers entering their products especially for these tests were General Bakelite Co., Perth Amboy, N. J., "Bakelite"; Redmanol Products Corp., Chicago, "Redmanol"; Mica Insulator Co. and Barrett Co., Chicago, "Shellac"; Wilbur Mfg. Co., Duluth, "Radio Cement." These well known products are all standard and obtainable for radio purposes. Paraffin with different compounds of bees wax and resin were also employed. The characteristics of these products were studied and measured before application to the coils.

**RESISTANCE OF DRIED VARNISHES**

The loss of charge method of Fig. 4A was again employed to determine resistances of dried varnishes. A dozen strips of specially prepared mica were cut as before in Fig. 6, the end clamps of copper being amalgamated and fixed directly to the mica. These strips were thoroughly oven dried and measured; their average resistance, for the ten selected, was 362,400 megohms. Then the strips were dipped into the different compounds which had been previously reduced to the same liquid viscosity—then they were hung horizontally and dried naturally for 72 hours. Measurements were made and the resistance for each was computed for one square centimeter of the varnish film. The strips being 4 centimeters gave a better average than by making them very short as the varnish's tendency is to bunch on short samples.

The following are resistances across 1 centimeter square of the material:

- Bakelite, air dried 72 hours, 7,205 megohms.
- Bakelite, oven dried 1 hour 150 F., 7,350 megohms.
- Redmanol, air dried 72 hours, 4,613.5 megohms.
- Redmanol, oven dried 1 hour, 150 F., 4,290 megohms.
- Radio Cement, Wilbur's, air dried 72 hours, 15,840 megohms.
- Radio Cement, oven dried 1 hour 125 F., 76,100 megohms.
- Shellac, air dried 72 hours, 12,875 megohms.
- Paraffin-beeswax 3/1, 4,612.8 megohms.
- Best cabinet varnish, air dried 72 hours, 18,570 megohms.
- Amyl acetate (Banana oil), 32,350 megohms.
- Plain celluloid, 5,020 megohms.

# Brandes

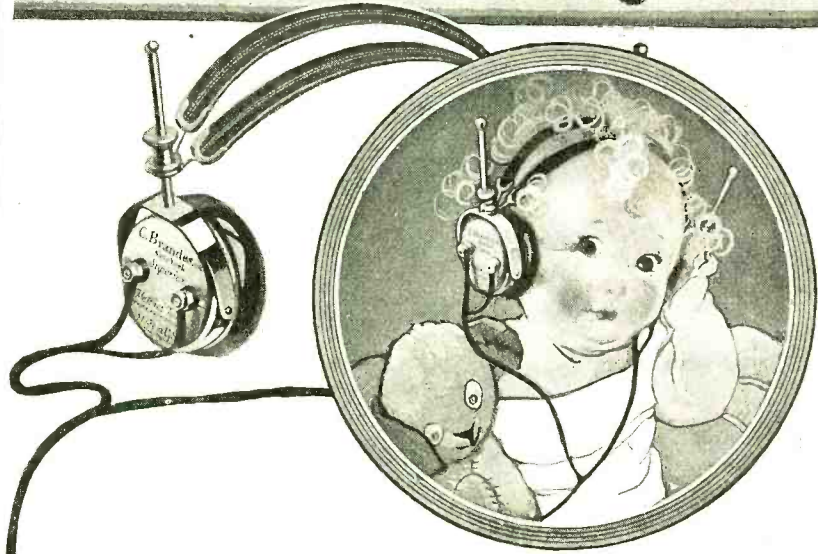

## His first taste of music!

The truly modern young person gets his first taste of music by Radio—and a Brandes. Catchy melodies and charming bed-time stories come to him clearly through a Brandes Matched Tone Headset.

Mother lets him wear only a Brandes because it's so much lighter in weight and won't catch in his curls. And she knows that his little ears will be trained to true harmony by the Matched Tone qualities of Brandes.

**NEW PRICES**

Superior  
\$6.00

Navy Type  
\$8.00

C.Brandes, Inc. - 237 Lafayette St., N.Y.C.

## Matched Tone Radio Headsets

TRADE MARK REG. U.S. PAT. OFF.

© C. Brandes, Inc., 1923.

**PATENTS.** WRITE FOR List of Patent Buyers, Three Guide Books and RECORD OF INVENTION BLANK before disclosing inventions. Send model or sketch and description of your invention for Examination and Instructions. Electrical cases a specialty. Highest references, reasonable terms, prompt attention. No charge for the above information  
**VICTOR J. EVANS & CO.**  
919 NINTH ST. WASHINGTON, D. C.

**PATENTS**  
DON'T LOSE YOUR RIGHTS  
Before disclosing your invention to anyone send for blank form "EVIDENCE OF CONCEPTION" to be signed and witnessed. Form and information concerning patents free.  
**LANCASTER & ALLWINE**  
270 Ouray Bldg., Washington, D. C.  
Originators of the form "Evidence of Conception"



Wonderful, new device, guides your hand; corrects your writing in few days. Big improvement in three hours. No failures. Complete outline FREE. Write C. J. Ozment, Dept. 32 St. Louis, Mo.

**PATENTS**  
If you have an invention and desire to secure a patent, send for our Free Guide Book, HOW TO GET YOUR PATENT. Tells our Terms, Methods, etc. Send model or sketch and description for our opinion of its patentable nature.  
**RANDOLPH & CO.**  
Dept. 459 Washington, D. C.

Warren Radio Loop, Cut Away to Show Construction.



**A Better Set with a Better Aerial**

Those who get the most out of their sets use a Warren Radio Loop. Eliminates interference; simplifies tuning. Wider range of frequencies on single coil. Fits inside cabinet or any small space. Many other advantages. Choice of experts. Buy a Warren Radio Loop for expert results.

Send for Bulletin T102, containing hook-ups

**WARREN RADIO LOOP**

Sharper Tuning  
One tuning adjustment — no others needed.

Directional  
Receives signals strongest.

Selective  
Picks out just the station you want to hear.

Portable  
Small, light, compact. Ideal for portable and mobile sets.

Wider Range of Frequencies  
on single coil. Small re-radiative effect. Fine for regenerative circuit.

**A Type For Every Set**

Type A-737 (300-700 meters) 6 inches square—non-directional	\$10.00
Type A-7236 (175-1000 meters) 6 inches square—non-directional	12.00
Type B-2537 (300-700 meters) 18 inches square—directional	20.00
Type BL-2520 (200-18,000 meters) with honeycomb coil mounting, 18 inches square—directional	25.00

V-DE-CO RADIO MFG. CO.  
Dept. N ASBURY PARK, N. J.

Bakelite is an excellent liquid product manufactured under a patented process, essentially the precipitant of combined formaldehyde and carboic acid. It is an amber fluid of considerably great viscosity which may be easily applied with a brush although pressure impregnation is preferable. When air dried its resistance increases slowly with time—which may be hastened by heating in a slow oven. Upon hardening it gives a clear, hard glazing thoroughly waterproof and very strong.

Redmanol is also a phenolic resin of dark brown color working somewhat like bakelite. However, its insulating properties are best when the coil is dried under heat and pressure although it air dries very well, slowly, of course, perhaps requiring two weeks for multi-layer coils to harden thoroughly. It gives a dark brown glazing of great strength and is waterproof.

Radio Cement is an opaque whitish fluid apparently a colloidal base suspended in amyl acetate and ether. It is applied with a brush and penetrates instantly every part of the insulation although this and its low capillarity prevents it from filling in solidly between turns. Two coatings give better results. It is an excellent insulator which dries very fast—within 10 minutes. It improves greatly by warming in a slow oven for not more than 15 minutes at 125 F. It has the fastest penetration of any varnish tested.

Orange shellac is, known by every one. It is an excellent insulator if the crystals are pure which is not often the case. It also has considerable strength. It is best applied thin for the first coating for penetration, then followed by a thicker coating of denser variety to glaze the coil. It should be air dried: never baked at high temperatures.

(See upper chart on page 551)

We have shown how resistance of inductors is improved by the exclusion of moisture. The following and final experiment was performed to show actual proofs of such improvement. The first four coils listed were made of identical dimensions and turns to show the comparative influences of different compounds. Other coils following were made up to show what gain to expect. Actual curves are shown in Fig. 12 where solid lines show the coil resistance before varnishing; the dotted lines the result after insulating them.

The "EZTOON" Easy Tune Radio Dial



is two dials in one with a 40 to 1 ratio

Gives a wonderfully fine Vernier adjustment. Stations that have always baffled you can be tuned in or out at will, with one hand. A quick, sharp, accurate tuner.

Saves the expense of a second set of adjustable plates on the condenser. Increases the sensitiveness and working efficiency of condenser, variometer, variocoupler, rheostat, potentiometer or tickler on all types of radio receivers.

Does away with friction springs, brakes and cogs or rubber clad gearing. No back lash or lost motion.

Attach to any instrument (3/16 in. or 1/4 in. shaft) without drilling or marring panel. Just tighten one set screw with a screw driver.

Sold under positive money-back guarantee.

3 in. dial.....\$2.00 4 in. dial.....\$2.25

Sent by parcel post prepaid.

Attractive quantity discounts to manufacturers, jobbers and retailers.

Send for circular.

**Butler Manufacturing Company**  
3235 W. Washington Street  
Indianapolis, Indiana

G. W. 5 Circuit Radio Plug

PATENT APPLIED FOR



PHONES  
LOUD SPEAKER  
SERIES  
PARALLEL  
SHUNT

Accommodates  
Head Set and Loud Speaker or Two Head Sets — permitting instant choice of Five Circuits without removing plug or changing tips.

Price \$1.50

At Your Dealer or Direct From Us  
MADE OF GENUINE BAKELITE  
Jobbers Write for Quantity Discounts

Manufactured by  
**G. E. WALKER CO., Inc.**  
1926 CHESTNUT ST. ST. LOUIS, MO.

\$11.85



**KRAG SPORTER** caliber 30/40 with 22 inch barrel; five shot with military sight for 2000 yards. Weight 7 3/4 lbs. In fine order. Special price \$11.85. Ball Cartridges \$2.50 per 100. 372 page Military catalog 50 cents. Circular for 2 cent stamp. Established 1865.

FRANCIS BANNERMAN SONS, 501 B'way, N. Y. City

You can be quickly cured, if you

**STAMMER**

Send 10 cents for 288-page book on Stammering and Stuttering, "Its Cause and Cure." It tells how I cured myself after stammering 20 yrs. B. N. Boone, 892 Bogue Bldg., 1147 N. 11th St., Indianapolis

Write for free catalog illustrating and describing our complete line of 1500 Good Tools

**GODELL-PRATT COMPANY**  
Toolsmiths  
Greenfield, Mass., U. S. A.

**RADIO BOOKS**

Latest and Best. Catalog Free.  
RAY DOBBINS  
146 West 27th St. Indianapolis, Ind.

No Hunting for the Sensitive Spot with the **GREWOL** Detector



Real detector efficiency made constant, lasting. Re-adjustment seldom required—and then made in a moment. No flimsy cat-whisker; no parts to wear loose. The GREWOL is super-sensitive, proof against all ordinary detector troubles—vibration, dust, oxidization, dampness. An excellent detector for reflex, duplex and all circuits. Fully patented. Unconditionally guaranteed. Tested and approved by Jack Binns, radio editor of the N. Y. Tribune.

\$2.00

If your dealer has no GREWOLS, send \$2 to us with your dealer's name.

Write for folder

**RANDEL WIRELESS CO.**  
11 Central Ave., Newark, N. J.  
Dealers and Jobbers—Write for Sales Proposition.

In conclusion we find resistances of coils as ordinarily used in radio circuits may permit leakage, which loss varies greatly from time to time. This is characteristic of many radio sets equipped with exposed windings of cotton and silk. Coil impregnation in any case, reduces the high frequency resistance 5 to 25 per cent, thus improving the power-factor of the unit. Several insulating com-

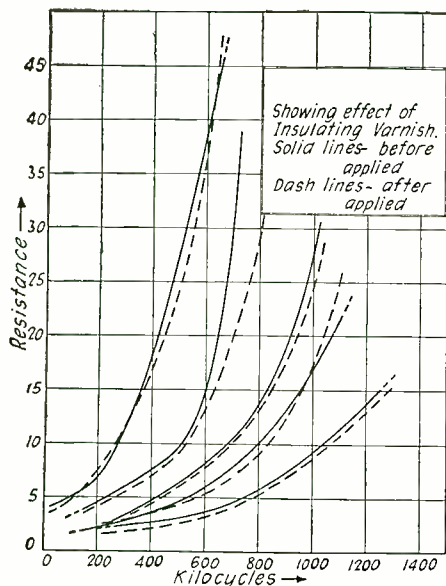

Fig. 12. The Resistance of a Coil is Usually Decreased by the Application of Insulating Varnish.

pounds have been examined and described, especially those showing good electrical properties. The affects upon resistance of leads, taps, dead ends, coupling and distributed capacity may appear at another time.

I trust that these data prepared expressly for RADIO NEWS may show to the reader many exact characteristics which may have been unexplained before and possibly the reader may have acquired a better insight to this evasive but important subject.

**AMPLIFIERS WITHOUT TUBES**

The problem of amplification and relaying has been solved, thanks to the vacuum tube, which is undoubtedly a wonderful device. However, scientists are still working toward simplification and especially in Europe a great deal of research work has been done to advance Radio a step further. Mr. Y. Neimhold, a German engineer, recently patented a new system of amplification which will probably prove to be a great improvement in audio-frequency amplification. The device used, instead of the vacuum tubes, is a somewhat similar apparatus having three electrodes and filled with a colloidal solution.

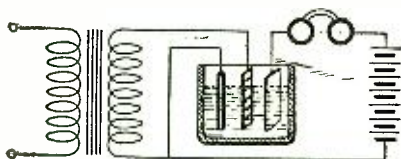

Fig. 1

The Arrangement of the Electrodes in the Colloidal Solution is Similar to the Disposition of Those in a Triode.

A colloidal liquid is a liquid mineral, which especially prepared, contains molecules of matter, these molecules being electrified. These liquids which are at present investigated by many laboratories present much interest, especially in biology.

Mr. Neimhold used in his "liquid tubes" some solutions of pyrogalic acid and hydrosol, and obtained encouraging results. The electrodes of the tubes consist of two plates

*Natural*  
**Re-PRODUCTION**  
*Atlas*  
**AMPLITONE**  
LOUD SPEAKER

\$25

ALL of the program, natural as the original, re-PRODUCED on the *Atlas Amplitone*. Faithfully responsive, not to just one small range of sound intensity, but to the *full scale* of tone harmonics. The "double diaphragm" — triumph of the radio and acoustic sciences — automatically accomodates itself to every pitch. Blast and distortion are entirely eliminated. The "double diaphragm" is adjustable to operate most efficiently with individual receiving conditions. Ask the nearest Atlas Amplitone dealer for a demonstration. Hear the difference this great innovation makes.

**Letters from Users Requested**

What have you accomplished with your Atlas Amplitone? Tell us about it!

*Write for Booklet "F"*  
Contains helpful information

*Sole Canadian Distributors*  
The Marconi Wireless Telegraph Company of Canada, Limited  
Montreal, Canada

**Multiple Electric Products Co. Inc.**  
ORANGE ST. RADIO DIVISION NEWARK, N. J.

**SUPER VALUES**

**LOUD SPEAKERS**

<p>List Price \$ 60.00 MAGNAVOX TYPE R3 ..... 35.00 MAGNAVOX TYPE R2 ..... 25.00 ATLAS AMPLITONE .....</p>	<p>OUR Price \$ 51.00 ..... 29.50 ..... 19.50 .....</p>	<p>Price List \$161.00 WESTERN ELECTRIC 10A ..... 55.00 WESTERN ELECTRIC 10D ..... 30.00 MUSIC MASTER .....</p>	<p>OUR Price \$125.75 ..... 44.00 ..... 24.50 .....</p>
--	---	---	---

<b>PHONES</b>	<b>FADA NEUTRODYNE PARTS</b>
Brandes ..... \$5.25 N & K German ..... 5.50 Dictograph ..... 5.50	LIST PRICE <b>\$25.00</b> OUR PRICE <b>\$18.75</b>
<b>CONDENSERS</b>	<b>TUBES</b>
3 Plate Vernier ..... \$ .90 23 Plate Vernier ..... 2.50 43 Plate Vernier ..... 2.75 23 Plate Plain ..... 1.50 43 Plate Plain ..... 1.90	UV200 Radiotron ..... \$3.95 UV201A Radiotron ..... 5.75 UV199 Radiotron ..... 5.75 WD11 Radiotron ..... 5.75 WD12 Radiotron ..... 5.75

<b>AUDIO TRANSFORMERS</b>	<b>LIST PRICE</b>
List Price \$4.50 All American, 3 to 1 Ratio ..... 4.75 All American, 5 to 1 Ratio ..... 4.75 All American, 10 to 1 Ratio ..... 4.25 Jefferson, 4 to 1 Ratio ..... 7.00 Jefferson, 10 to 1 Ratio .....	OUR Price \$3.95 ..... 4.10 ..... 4.10 ..... 3.75 ..... 5.55 .....

All Mail Orders Shipped Promptly. Write for Our Catalogue D. Send Money Order, including Postage.

**HANES-ZENER CO., 3 West 29th Street, New York City**  
The RADIO MAIL ORDER HOUSE—Known For Low Prices

Don't Miss This Clue

**"The Radio Detective"**

Arthur B. Reeve's thrilling new story of CRAIG KENNEDY Famous Scientific Detective begins in the October

**BOYS' LIFE**

The Boy Scouts' Magazine

Ask your newsdealer today or write to

200 FIFTH AVE., N. Y.

By Subscription \$2 a year

and a grid connected as shown in the sketch. The amplifying effect of this arrangement seems due to a negative resistance effect, but the solution must be in a colloidal state and no electrolysis should take place. The electric phenomenon is still due to electrons, but these travel in liquid instead of vacuum. There is open an interesting field for research and we hope to be able soon to publish more data on this interesting process which, if developed, might mean much to the radio industry.

**Station 2BGM**

(Continued from page 547)

has "brass-pounded" his way to fame, qualifying on that memorable occasion of the trans-Atlantic tests as one of America's foremost amateurs. Many will remember IBCG, at Greenwich, Conn., temporarily installed for the tests. Mr. Inman was one of that "go-getter" group who made such a splash in the ether through IBCG that Mr. Godley "shivered his timbers" at the thought of what might happen to his super-heterodyne receiver, were they to use more power.

However, we are interested in Station 2BGM, the work of Mr. Inman. It is located on the twelfth floor of a magnificent apartment house. The antenna system is composed of a four-wire cage aerial, 75' long and 70' above the ground. A four-wire cage lead-in runs directly to a large lightning switch and thence to an aerial change-over switch. The aerial is clear of any large structures, and is fastened to the top of the elevator shaft of an adjacent apartment house. The ground includes the steam and water-pipes of the apartment, the fire-escape and a lightning ground which consists of a No. 4 solid copper wire, running down to a large surface connection made to earth. The most noticeable part of Station 2BGM is the transmitter. This was designed for pure C. W. transmission only, and employs the Radio Corporation Intermediate circuit. Three Radiotron 250-watt tubes are employed, connected in parallel, and used as oscillators; the filaments of these are controlled separately by large rheostats.

A very good view of these monstrous tubes can be had from the photograph reprinted herewith. Seven meters are situated on the upper portion of the panel, directly above the filament rheostat control knob. The top three are milliammeters, one of which is connected in the plate-circuit of each tube. The next two are thermo-coupled ammeters; one designating the radiation in amperes, the other being in the main circuit to the tubes. The lower of the left meters tells the exact voltage impressed upon the plates of the transmitting tubes, while the one to the right tells at a glance the voltage impressed upon the filaments. The current for both the plates and the filaments of the tubes is supplied by a motor-generator, which, unfortunately, cannot be seen in the photographs. This is an "Esco" machine of 2,000 R.P.M.

The generator for the filament current is coupled to one end of the motor shaft. This is a 750-watt machine and develops 11.5 volts. The 1,000 watt, 2,000-volt plate generator is coupled to the other end of the shaft of the motor. The entire motor-generator unit is mounted on a thick sponge rubber base, which effectively absorbs all vibrations. This transmitter employs a relay for making and breaking the circuit; this being operated by a small hand-key on the operating table. Mr. Inman points out a difficulty which he experienced when first oper-



ESTAB. 1876

# W.L. DOUGLAS

**\$7.00 & \$8.00 SHOES ALSO MANY \$5 & \$6**  
**\$4.50 & \$5.00 SHOES FOR BOYS**

**WEAR W. L. DOUGLAS SHOES AND SAVE MONEY**

They are made of the best and finest leathers. The wide range of kinds, styles and prices provides suitable shoes for men and women in all walks of life. The quality is unsurpassed. The smart styles are leaders in the fashion centers of America. Whatever your ideal of a shoe may be, you will find it in the W. L. Douglas line of shoes.

Why pay high prices for your shoes? W. L. Douglas shoes are exceptionally good value. The quality, style and workmanship compare favorably with shoes selling at higher prices. If you had your shoes made to order, you couldn't get more perfect shoes. Frankly, is it not worth while in these days of high cost of living for you to save money on your footwear when the opportunity offers?

For thirty-seven years W. L. Douglas name and portrait have stood for a high standard of quality and dependable value. For economy and satisfactory service, wear shoes that bear this trade mark. We carry in our stores a complete stock of high class, stylish, up-to-date Men's, Women's and Boys' shoes. If not convenient to call at one of our stores, ask your local dealer for W. L. Douglas shoes. Look for the name and price stamped on the sole. If he cannot supply you, write for Illustrated Catalog showing how to order shoes by mail, postage free.

*W.L. Douglas* President W. L. Douglas Shoe Co.  
172 Spark St., Brockton, Mass.

Style No. 870  
Tan Norwegian  
Oxford



Style No. 1518  
Patent Colt One-Strap  
Pump  
Also in Black Satin  
Style No. 1519



Style No. 526  
Gun Metal Calf  
Bal.  
Also in Sunset  
Russia Calf  
Style No. 529



Style No. 1506  
Tony Real Oxford  
Cork Welt  
Also in Gun Metal  
Style No. 1505



Style No. 811  
Brown Kid Blucher  
Also in Black Kid  
Style No. 708



Style No. 513  
Black Kid Bal.  
Also in Brown Kid Oxford  
Style No. 690 and Black  
Kid Oxford Style No. 515



**TO MERCHANTS: If no dealer in your town handles W. L. Douglas shoes, write today for exclusive rights to handle this quick-selling, quick turn-over line.**

strength of the long wave-length stations decreased, requiring a larger value of oscillating inductance thereby decreasing the variation frequency. This last mentioned point is the only fact that directly bears upon the two portions of the theory, as it is in relation to the volume of the signals received and has to do with the amplitude of the variation frequency. Referring to the second portion of the theory and to Fig. 7, when in operation, the low frequency oscillator impresses upon the grid of the vacuum tube, oscillations in the order of from 10,000 to 17,000 cycles per second, these

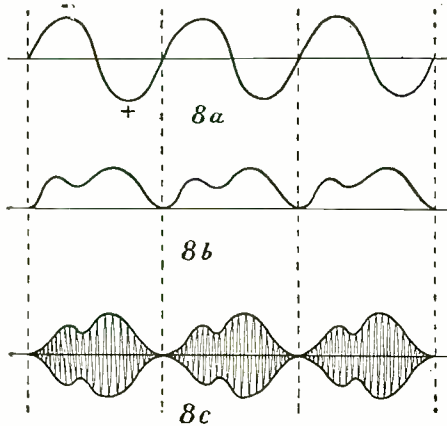

Illustrating the Super-Inducing of An Audible Signal Frequency Upon the Variation Frequency Oscillations.

being positive to negative variation. The effect of this impression is two-fold. In first: it tends, by choice of bias, to shift the locus of the tube action to a point on the characteristic curve where any voltage changes, such as those due to the impression of signal energy on the grid of the vacuum tube, will effectively displace the normal locus to a different position, thus producing considerable changes in the grid voltage, and produce large changes in the plate voltage and the variation of the plate current. In second: still further large changes in grid and plate voltage are obtained from the following presumed action. The low or audio frequency oscillations produced by the low frequency oscillator impressed upon the grid of the vacuum tube, are of a constant and uniform amplitude.

The impression of this audible frequency upon the grid of the tube, sets up a similar voltage and current variation in the plate-filament circuit of the receiver, which is heard in the telephones as the original frequency produced by the low frequency oscillator. So long as the low frequency oscillator produces these voltage variations, there will be a similar plate-filament current. These oscillations are illustrated in Fig 8A.

To further the action: upon the impression of a signal energy of a radio frequency upon the grid of the vacuum tube, it is converted in the manner heretofore described. The resultant audio-frequency current produced in the plate-filament circuit of the vacuum tube, illustrated in Fig. 8B, is at certain time periods super-imposed upon the audio frequency oscillations produced by the low frequency oscillator, which are traversing the grid-plate circuit in the course of their oscillation. The super-imposing takes place in the plate filament circuit, and tends to displace the constant audio frequency oscillations which take on the shape and character of the audible signal frequency, thus producing large changes in their amplitude. The effected audible frequency now has the character and identical shape of the resultant signal frequency produced in the plate-filament circuit. This formation is illustrated in Fig. 8C.

Due to the manner in which the local audible frequency traverses the grid-plate







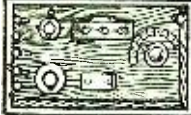

# RADIO

AT N.Y. PRICES

## Daily Parcel Post

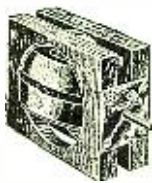
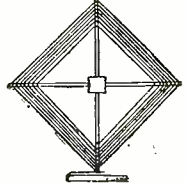

<p><b>DIETZEN Tube Set</b></p> <p>Completely assembled in handsome oak cabinet; (without tube), \$10.</p> 	<p><b>DIETZEN Vernier Condenser</b></p> <p>14 Plate \$2.65 24 Plate \$2.95 46 Plate \$3.45</p> 	<p><b>DIETZEN Vacuum Tube</b></p> <p>1 1/2 Volt. Operates on one dry cell, either with or without B battery. Wiring diagram FREE with each tube.</p> <p><b>\$1.00 Socket 25c</b></p> 	<p><b>A.B.C. "B" Battery</b></p> <p>22 1/2 V. small ..... \$ .95 Medium ..... 1.45 Large ..... 1.95 45 V. small ..... 1.95 Medium ..... 2.50 Large ..... 3.50</p>  <p>1 1/2 V. twin double duty "A" battery 75c.</p>
<p><b>AMPLETONE HORN--Nicked</b></p> <p>18 inches high \$3.95 List \$12.</p> 	<p><b>WORK-RITE Variometer, \$2.95</b></p> 	<p><b>Dietsen Loop Aerial</b></p> <p>Set up in 5 minutes. All parts complete, \$1.</p> 	<p><b>BRISTOL AUDIOPHONE LOUD SPEAKER</b></p> <p>Jr. \$22.50 (as illustrated) Sr. \$32.50 1 stage power amplifier \$25.00</p> 

Variable condenser 21 plate (bakelite end) \$1.65 Variable condenser 43 plate (bakelite end) 1.95 7 strand aerial wire, 100 foot ..... .65 Freshman grid leak and condenser combined .85 Argus Lightning arrester ..... .95 Cock-a-Day coils ..... 2.45 Rheinartz coils ..... 1.45 Dietsen moulded variometer ..... 5.95 Dietsen moulded variocoupler ..... 5.95 Brandes phones ..... 5.45 Dietsen phones (3000 ohms) ..... 3.75 Dictograph phones ..... 5.45	Tri Coil radio frequency transformer .... \$1.95 Rheostat 6 ohm ..... .45 Rheostat 30 ohm ..... .59 Test Rite battery hydrometer ..... .49 Potentiometer 250-400 ohm ..... .95 Dial, 2 inch ..... .25 Dial, 3 inch ..... .35 Dial, 4 inch ..... .49 Single open circuit jack ..... .40 Double closed circuit jack ..... .60 Socket standard bakelite ..... .49 Socket UV-199 bakelite ..... .49 Tubes—WD-11, WD-12, UV-199, UV-201A 5.75
--	--

**We Pay Parcel Post Charges on All Orders. Money Order or Personal Check Accepted.**

**Money Refunded If Not Satisfactory.**



ESTABLISHED 1882

## 71 Cortlandt Street

Dept. G. NEW YORK

America's Greatest Radio Mail Order House

# World BATTERIES

## SAVE YOU 50%

"WORLDS OF PERFORMANCE"



-and you get a written two Year guarantee

We maintain the same high quality material and workmanship found on the most expensive batteries, and still are able to allow our remarkably low sale price by greatly reducing our overhead and sale costs. Thousands of users enjoy the dependable qualities of our battery. World battery owners "tell their friends." This is our best proof of performance.

**COMPARE THESE PRICES!**

Special 2 Volt Storage Battery ..... \$5.00	6 Volt, 60 Amp. .... \$ 8.50
For WD11 and WD12 tubes. Will run 200 hours on one charge. Rechargeable.	6 Volt, 80 Amp. .... 10.00
Special 4 Volt Storage Battery ..... \$8.00	6 Volt, 100 Amp. .... 12.50
For UV199 tubes. Same features as 2 Volt.	6 Volt, 120 Amp. .... 14.50
	6 Volt, 140 Amp. .... 16.00

**SEND NO MONEY!**

We ship C.O.D. subject to inspection or will allow 5 percent discount for cash with order. Shipment made same day order is received. Save 50 percent on your next battery and get better service and longer life. Our written 2-year iron-clad guarantee is your proof of satisfaction. Order today—NOW!

**WORLD BATTERY CO., DEPT. 10, 1219 So. Wabash Ave., CHICAGO, ILL.**

# ORDER

The above prices are the lowest in World Battery history and are in keeping with our policy of "Greater Value for Less Money." Take advantage of them NOW!

# NOW!

CIRCULATION 60,000 COPIES

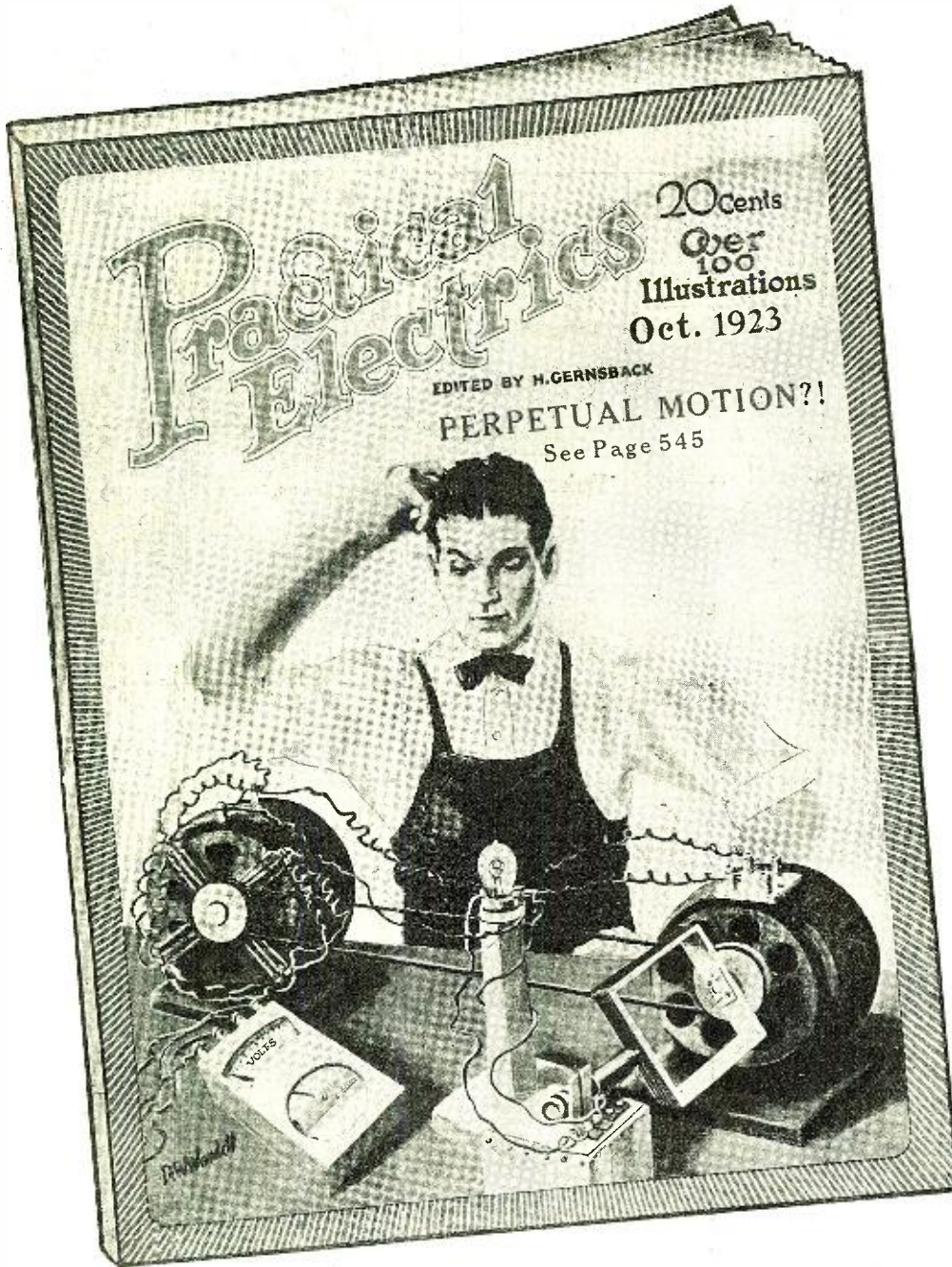

This magazine is edited by  
**H. GERNSBACK**  
 also Editor of  
**RADIO NEWS**  
 and  
**SCIENCE and INVENTION**

**100 Articles**  
**Over**  
**100 Illustrations**

**FOR SALE AT**  
**ALL NEWS STANDS**

**20c. the Copy**  
**\$2.00 a Year**  
 Canada and Foreign  
**\$2.50 a Year**

SEND FOR  
**FREE**  
 SAMPLE COPY  
 TODAY

See Coupon Below  
 for **SPECIAL OFFER**

# “The Electrical Magazine for Everybody”

**P**RACTICAL ELECTRICS is probably the most novel magazine of its kind ever conceived. It is personally edited by H. Gernsback, editor of SCIENCE & INVENTION and RADIO NEWS. Mr. Gernsback, who founded the old “Modern Electrics” as well as the “Electrical Experimenter,” knows thoroughly what his readers want and have wanted for many years. PRACTICAL ELECTRICS, the 100% electrical magazine eclipses the best that was in “Modern Electrics” and “Electrical Experimenter.”

Electricity covers such a tremendous field that the man who does not keep abreast with it does himself a great injustice. PRACTICAL ELECTRICS covers that field from every angle. It is written in plain every-day language that all can understand. It portrays the entire electrical development of the month faithfully in non-technical language. It caters to everyone interested in electricity, be he a layman, an experimenter, an electrician or an engineer—each will find in this magazine a department for himself and plenty more.

The November issue now on the news-stands contains 48 pages, over 100 different articles and over 100 illustrations, with an artistic cover in three colors. Professor T. O’Conor Sjoane, Ph.D., is associate editor of the magazine.

**INTERESTING ARTICLES IN NOVEMBER**  
**“PRACTICAL ELECTRICS”**  
 Mercury Vapor Arcs, By Allan R. Kenworthy  
 Floating Needles and the Magnet, By Dr. Albert Neuburger, Berlin  
 Carbon Disc Rheostat Finding Positive Pole  
 Little Known Methods of Producing Electricity, By Raymond B. Wailes  
 Echo Sounding, describing a new method of sounding at sea employing microphones.  
 Thermic Telephones, concluding installment of a remarkable paper on this subject.

### PRIZES

This magazine offers a number of prizes, as follows:

Our \$50.00 Prize Contest for Junior Electricians and Electrical Experimenters includes as its elements simplicity, as great a degree of novelty as possible, and practicability.

Awards in the interesting \$100 prize contest will be announced, for best new uses for old spark plugs.

Also a new prize contest giving four prizes amounting to \$37.50 for the best account of an odd electrical experience.

\$3.00 for the best article on Elec-Tricks, the new department.

\$3.00 for the best “short-circuit,” the semi-humorous department.

In addition to this, the magazine pays high prices for all electrical experiments, electrical articles, etc. See current issue for full details.

This issue also contains articles by some of the greatest electrical writers, workers and students. The magazine will prove a revelation to any one interested in electricity.

Every issue besides its many other features contains the following departments:

- “New Things Electric”
- “Experimental Electrics”
- “Electrical Digest”
- “Junior Electrician”
- “Elec-Tricks”
- “Motor Electrics”
- “Short Circuits”

“How and Why” (Questions and Answers.)

Make all checks payable to: “Practical Electrics Co.”

R. N. 11-23

### SPECIAL OFFER

Gentlemen:

Although your regular price is \$2.00 per year, you will accept my subscription at \$1.75 per year (Canada and foreign \$2.25). I enclose the money herewith and I have written my name and address in margin below.

**PRACTICAL ELECTRICS CO., 53 Park Place, New York**

circuit, it reverses at regular time intervals and after being moulded by the super-inducing of the signal frequency upon it, it again reaches the grid where it produces large changes in grid voltage, due to its now uniform structure, and therefore, considerably larger resultant changes in plate voltage and the effective variation of the plate current. In other words, the locally produced audio frequency oscillations act as a carrier from the plate to the grid of the vacuum tube, of the audible signal energy. Similar to a carrier wave with a modulated speech wave impressed upon it, the local audio-frequency oscillations are enveloped by the rectified audio-frequency telephone current as was illustrated in Fig. 8C. This presumed action may well be termed a form of audio-frequency regeneration and is not so complicated that it cannot be attached to the first portion of the theory.

The values of the simplified circuit are quite important, its operation being indifferent if not adhered to. Of primary importance are the variometers. These should have a high ratio of inductance (for broadcast reception) and preferably have the stator coils close to the rotor coils. Variometers having the stator coils wound on the outside of the stator form are poor for this work. The oscillating coil in the grid circuit should be one having low distributed capacity such as the Honeycomb, Duo-Lateral or Morecroft type. It should preferably have an inductance value of 125 millihenries or so. Its inductive relation to the variometers matters little, in fact it can be fastened to the side of the grid variometer if desired. As a collective agency, a ground lead will usually suffice. If both aerial and ground are employed they are connected as shown in Fig. 7. If but one is used (aerial or ground) it should connect to point "A." A Western Electric "E" tube or 216-A is the most satisfactory for use with this circuit the UV-201A being a close second. "B" voltages of from 60 to 150 are satisfactory. When dry cell tubes are employed a "B" voltage of 45 is sufficient.

The possibilities of this or a similar circuit are encouraging. Where for an example, considerable volume is desired, a one-stage audio-frequency amplifier can be added with but small change in the operating characteristics of the circuit.

Since the circuit is comparatively broad in respect to a three-circuit regenerative receiver, the addition of a stage of radio frequency amplification suggests itself. The circuit of course becomes sharper in its tuning qualities as the variation frequency is increased, but such a procedure is a disadvantage due to the fact that there is one frequency that is best suited for a broad band of wave-lengths. The addition of radio frequency amplification will allow a uniform variation frequency, yet pass to this circuit the signal energy from one station only. This necessarily eliminates the chance of the circuit proper, of automatically becoming in resonance or partially in resonance with the wave of another station.

It was mentioned before that excellent results were obtained on amateur waves and the lower broadcast waves with a 30 millihenry inductance in place of the usual 125-millihenry inductance. The variation frequency was naturally super-audible. It is believed that such a frequency can be maintained at the higher waves if the circuit is redesigned, and that consistent results could be obtained on a wide band of wave-lengths. A second coil of the same value included in the plate circuit, as in the original super-regenerative circuit would tend to better balance the circuit.

**LEROY HIPSHER**

The editor of this publication desires to get in touch with the above named. If anyone knows his whereabouts, he will oblige the Editor by advising him at once.  
*Editor, Radio News.*

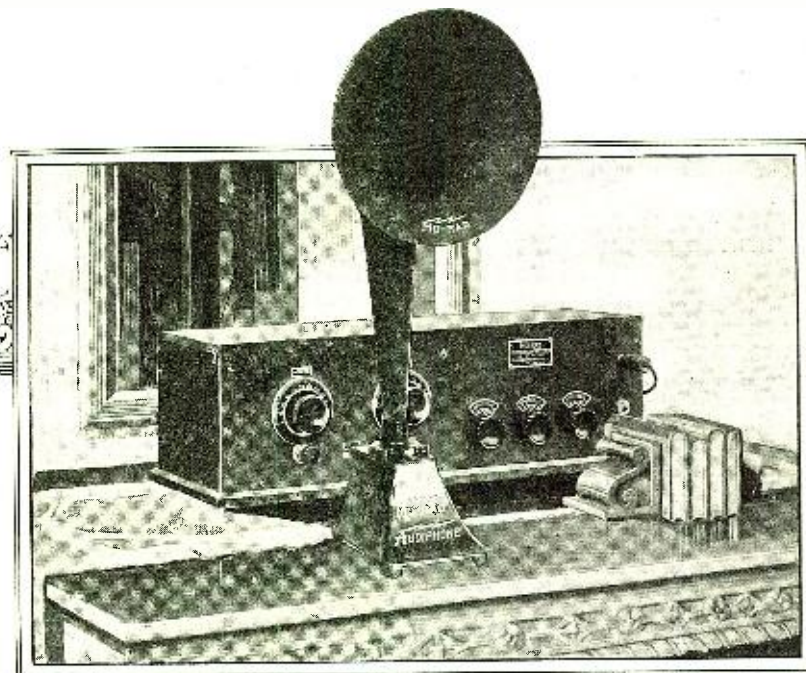

*A New MU-RAD Accomplishment —*  
**The MU-RAD AUDIPHONE**

The super-sensitive mica diaphragm produces sound by the contraction and expansion of an actuating contact, just as the vocal cords produce the voice.

No Extra Battery Connections

**Price \$25**

**T**HE revolution, wrought in radio reception by the *Mu-Rad Receiver*, is equalled by this radical improvement of sound amplification. The *Mu-Rad Audiphone* aimed for a higher perfection than ever attempted—duplication in electro-mechanical form of the greatest sound producing organ, the human voice. The result of five years' continuous research is a radio reproducer worthy of a finer classification than "loud speaker"; it is a *new radio instrument!*

*Write for Literature and the Name of the Nearest Mu-Rad Dealer Demonstrating the Mu-Rad Audiphone.*

**MU-RAD LABORATORIES, INC.**  
**801 FIFTH AVE. ASBURY PARK, NEW JERSEY**

**JUST THE BOOK YOU WANTED**  
**"RADIO NEWS"**  
**Amateurs' Handibook**  
Volume No. 1

Check full of radio constructive and instructive articles from cover to cover. Written by foremost radio authorities, in plain everyday language which everyone can understand. Sections include articles on Receiving Sets and Sundry Apparatus, Transmitters and Accessories, Radio Theory, Vacuum Tube Data, and Practical Hints for the Amateur. A book which also serves as a ready reference and should find a place in the library of every amateur. It contains 224 pages and over 375 illustrations, diagrams, and photographs, bound in a multi-colored heavy board.

On sale at all leading radio stores. If your dealer cannot supply you, pin a dollar bill to this ad and write your name and address in the margin below, and book will be forwarded to you postpaid. **PRICE, \$1.00.**

**EXPERIMENTER PUBLISHING CO., Inc.**  
53 Park Place, New York.

**Loud \$1 Speaker**  
**Radio Adapter**

Hear all broadcasting through phonograph. Make your own horn. Attach B-R Phonadapter to YOUR phonograph. All can hear. Entire family, neighbors, guests can hear operas, lectures, latest news, with this adapter. Stretches over receiver of any standard type head-set and attaches to tone-arm of ANY phonograph. Made of soft, pure gum rubber. Quickly attached and removed. Thousands in use. Will not amplify or distort. For single receiver **\$.50**

For pair of receivers (more than twice the volume) **\$1**  
Go to your dealer. If he cannot supply you send money order, check or currency at our risk. Prompt delivery—postpaid. Also send us name of favorite radio dealer.

**The Beckley Ralston Company**  
1803 So. Michigan Ave., Chicago, Ill.





Patents

Inventions Commercialized. Patented or unpatented. Write Adam Fisher Mfg. Co., 278, St. Louis, Mo.

Unpatented Ideas can be sold. I tell you how and help you make the sale. Particulars free. Write W. A. Greene, Jenifer Building, Washington, D. C.

Personal

Correspondence Club—Many wealthy members everywhere. Fascinating particulars free. Smith, Box 1167Y, Denver, Colo.

Lonely Hearts—Exchange letters; make interesting new friends in our jolly club. Eva Moore, Box 908, Jacksonville, Florida. Enclose stamp.

Exchange cheery letters with new friends. Write Betty Lee, Inc., 4254 Broadway, New York City. Stamp appreciated.

Exchange interesting letters with new friends. Dolly Gray Club, Box 186G, Denver, Colo.

Lonesome—Join our club—make acquaintances everywhere. Big illustrated book with descriptions and photos, sent in plain wrapper for ten cents. Bonafide Co., Dept. 58, Kansas City, Mo.

Printing

200 Letterheads and Envelopes, printed, \$2.00, prepaid. King Supply Co., 335 Taylor, Topeka, Kansas.

Radio Equipment

We can save you money on any kind of radio equipment. Our prices are guaranteed to be lower. Send stamps for large price list. Cut Rate Radio Co., P. O. Box 472, Newark, N. J.

Genuine Edison Elements (new) for making "B" Batteries, obtained from U. S. Government. A positive and negative element—6c; glass tube—3c; all other parts at reasonable prices. Postage, etc. 50c extra per order. Free instructions. Todd Electric Company, 109 West 25th St., New York.

Scenery to Rent

Settings for Opera, Plays, Minstrels. Plush Drops. Address Amelia Grain, Philadelphia.

Stammering

St-Stu-t-t-tering and Stammering cured at home. Instructive booklet free. Walter McDonnell, 121 Potomac Bank Bldg., Washington, D. C.

Stamps and Coins

Free Packet. Ukraine, Bulgaria, Turkey, etc., with request for 50 percent, 60 percent sheets. Enclose 2c postage, 50 var. S. America, Australia, etc., 10c. George Flagg, 270 Wyoming Ave., Melrose, Mass.

Telegraphy

Used Omnigraphs bought and sold. John Percival, 2115 York, Des Moines, Iowa.

Learn either code in one hour. Radio Code Chart and Code Cards only \$1 complete. Particulars free. John Percival, 2115 York, Des Moines, Iowa.

Telegraphy in a week. A fact pending patent. Medellin Code. Licensed only for amateur use. \$1.00 postpaid. A. U. Medellin, Mesilla Park, N. M.

Learn Morse Telegraph. Expert telegraphers teach you at home. Individual instruction. Method recommended by railroad and commercial officials who have positions waiting for you. Experienced telegraphers use this automatic instructor to become experts. Booklet RN free. Wireless telegraphy free. Learn-O-Graph Company, Bogota, N. J.

Telegraphy—Both Morse and Wireless taught thoroughly and quickly. Tremendous demand. Big salaries. Wonderful opportunities. Expenses low; chance to earn part. School established fifty years. Catalog free. Dodge's Institute, Cour St., Valparaiso, Ind.

Ventriloquism

Ventriloquism taught almost anyone at home. Small cost. Send 2c stamp today for particulars and proof. Geo. W. Smith, Room M-807, 125 N. Jefferson Ave., Peoria, Ill.

Wireless

Molded Variometers green silk \$2.50, Variocouplers \$3.75, same Litz wound \$1.50 extra. Wooden Variometers \$1.50. 180° variocouplers \$1.35 Cockaday, 600 meter full mounted four coil set \$1.85, 3" dials \$2.25, 105 turn 7 tap coils \$1.75, 150 turn \$1.95 straight, spider web and bank wound coils to order. Celebrated Ultra Audion assemblies, drilled panel \$7.75, the all vernier adjustment type \$11.75, Cockaday assemblies \$10.50, cabinets extra. Guaranteed extra volume loud speakers, horn 18" high, 10" dia. \$16.50, Transformers \$3.25, Clivian Radio Factories, Clinton and Van Buren Sts., Chicago, Ill.

Tube Specials 1V199, 1V201, 1V201A, WD11, WD12, C299, C301, C301A, DV-1, DV-6 \$5.50, Electric Soldering Iron \$2.00, Bradleystat \$1.60, Radiola (RC) or (V) complete \$120.00, Amp. Transformer \$2.50, Bakelite Variometers and Couplers \$7.00, Radiola Senior \$58.00, Freed-Eisemann Neutrodyne Receiver (NR-5) \$140.00, Postpaid. Dealers wanted. C. H. Anderson, Lewistown, Mont.

Wireless—(Continued)

Pure Sheet Aluminum \$1.50 square foot. Electrical Specialty Company, Valparaiso, Indiana.

Boys—Make big money. Selling a few loud crystals to friends, send 40c for sample and big offer. Hubbard Laboratories, 1944 Cabrillo St., San Francisco.

Transmitting Apparatus. 3 DeForest Midset Radiophones \$72.00 each, 1 DeForest Buzzer Radiophone \$108.00, 1 Acme F1 1/2 K. W. Spark Transformer \$15.00, 3 Federal Desk Type Microphones \$1.90 each, 3 DeForest Singer tubes \$15.00 each, 1 R. & M. 500 Volt Motorgenerator 110 volt C. C. motor \$76.00. Hickson Electric Co., 36 South Ave., Rochester, N. Y.

5c Lettered binding posts, complete set eight—60c two sets—\$1.00. Prepaid, same day. Stamps accepted. Everything in radio. Ask for quotations. List for stamp. Klasing Radio Laboratories, Kent, Ohio.

Radio Generators—500 volt 100 watt \$28.50 each. Battery Chargers \$12.50. High Speed Motors, Motor Generator Sets, all sizes. Motor Specialties Co., Crafton, Penna.

Learn Radio. See the world. Splendid opportunities in wonderful field. Be a successful Nola Graduate. Nola Radio School, New Orleans, La.

Radio Repairs and Specialty Work. Standard apparatus in stock. Expert service. Nola Radio Company, New Orleans, La.

Storage "B" Battery, lead type, over 2% AH capacity. Size of elements 2 3/4 x 3 1/2 x 3-16. In special tube with strap. Shipped dry, guaranteed. 35c each, postpaid. \$16 for fifty. E. E. Patten, 6709 Carleton Ave., Seattle, Wash.

Build your own electrolytic storage battery charger. Plates and complete instructions, \$1.00. Descriptive circular free. Peerless Electrical Parts Co., 165 Harris, Rochester, N. Y.

Immediate delivery. Tubes, Magnavox, Phones, Battery Chargers, storage and "B" Batteries, Couplers, Variometers, Condensers and all parts with Radio Corporation, DeForest and "Neutrodyne" Receiving Sets. R. B. Electric Co., Distributors, Galva, Ill.

60,000 miles in a Home made Receiver. 2600 mile range. 100 station log and hook-up for the asking. Spencer Roach, 2905 Columbia Ave., Phila.

Magnavox Type R3. Latest nationally advertised reproducers. List \$35. Introductory offer \$25. The factory sealed carton is your guarantee. Radio Central, Dept. R, Abilene, Kansas.

Wouldn't you like to avoid forcing your set to get volume on weak stations? Then try our special third stage Audio Amplifier which brings the faint distant orchestra right into your room. Each \$12. With tube \$18.50. Radio Central, Abilene, Kansas.

Wireless—(Continued)

Boys! Don't Overlook This. The "Raseco" Baby Detector. Greatest detector ever brought out with molded base. Fully adjustable. See former advertisements in this publication, or our catalog. Detector with Galena Crystal, complete 50c, the same detector with Iadocrite Crystal, 75c prepaid. Send for yours today. Radio Specialty Company, 96-98 Park Place, New York City.

Attention!—50 Vacuum tube hook-ups. The greatest collection of vacuum tube circuits ever brought under two covers at such insignificant cost. These diagrams will be found in the great "Raseco" catalog, which contains raw materials and parts in a greater profusion than any other catalog. 15c in stamps, or coin, will bring the catalog to you. Radio Specialty Co., 96-98 Park Place, N. Y.

Build your sets with quality parts and get sure results, Radio Parts Co., Box 56, Dunellen, N. J.

2,500 mile. Efficient Regenerative 3 Tube Receiver, other Radio Apparatus, cheap, including Motor generator! Write S. Strobel, 3923 N. 6th St., Philadelphia, Pa.

The Diamond Crystal, mounted in Sarnialite no heat in mounting. Every crystal tested on music 400 miles away. Price with directions for building F. G. S. Long distance crystal set 50c, or with my new regenerative one bulb reflex circuit 75c. This circuit requires no transformers. Fred G. Smith, Box 113, Port Huron, Michigan.

Radio Tube Repairs. Radiotron, Cunningham, A & P Detectors \$2.75; Amplifiers \$3.00, WD11, 199, 201A, 202—\$3.50 etc., 1 day service. Prompt deliveries and satisfactory results guaranteed. S. Strobel & Co., 3923 N. 6 St., Philadelphia, Pa.

Radio Dealers write for attractive quotations on nationally advertised goods. Radio Central, Abilene, Kansas.

The How and Why of Radio Apparatus, by H. W. Secor, E. E. This newest book on radio matters fills a distinct gap in wireless literature in that, while the treatment is made as understandable and as free from mathematics as possible, it at the same time incorporates a wealth of technique and instruction for the Radio Amateur—the Radio Operator—the Installation and Designing Expert—as well as teachers and students of the subject in general. A very broad field has been covered by the author, at the same time giving a great deal of information not found in other text books. If you are engaged in any branch of the Radio or allied arts at all you will surely need this latest contribution to radio literature, which is destined to be found on every radio man's book shelf before long. A glance at the following list of chapters gives but a very scant idea of the extensive and useful radio knowledge provided in its text: The Induction Coil; The Alternating Current Transformer; Radio Transmitting Condensers; The Spark Gaps; Radio Transmitting Inductances; Radio Receiving Tuners; Radio Receiving Condensers; Detectors; Telephone Receivers; Radio Amplifiers; Construction of a Direct Reading Wavemeter and Measurement of Inductances; Appendix containing very useful tables, covering all subjects treated in this very unusual book. This newest of Radio Works, cloth bound in Vellum de Luxe, Gold Stamped and Hand Sewed, has 160 pages. Size of book 6x9 inches. The How and Why of Radio Apparatus. Postpaid, \$1.75. Experimenter Publishing Co., Book Dept., 53 Park Place, New York City.

TRADE "E S C O" MARK

Quality always has been, and always will be, The World's safest investment.

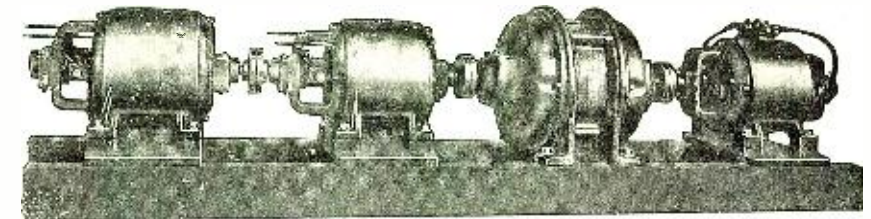

This is a Special 4 Unit Set for Wis. Dep't. of Markets—the largest broadcasting station in existence. A 10-h.p., 220-V., 60-cycle, 3-phase motor; two 1600 V., 2000 W. generators to operate in series, producing 2000 V. 4000 W. and one 12 V., 2000 W. Filament Current Generator.

These two, and many other types, used by most prominent Educational Institutions, various U. S. Government Departments, Research Laboratories, Newspapers, Department Stores.

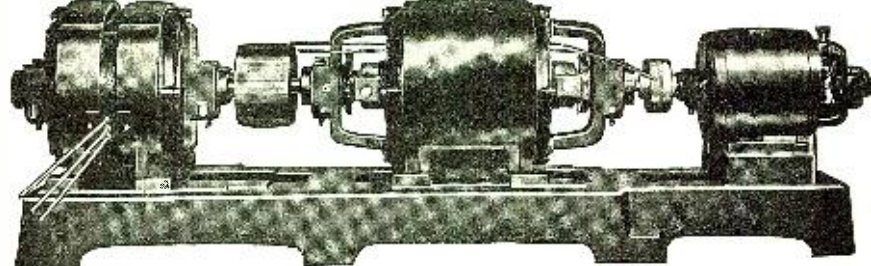

Sold by Principal dealers in U. S. and Abroad. Ask for Bulletin 248

ELECTRIC SPECIALTY CO.

211 SOUTH STREET STAMFORD, CONN., U. S. A. PIONEERS IN DEVELOPING QUALITY WIRELESS APPARATUS.

# The Universal Bradleystat subdues static in Cuba!

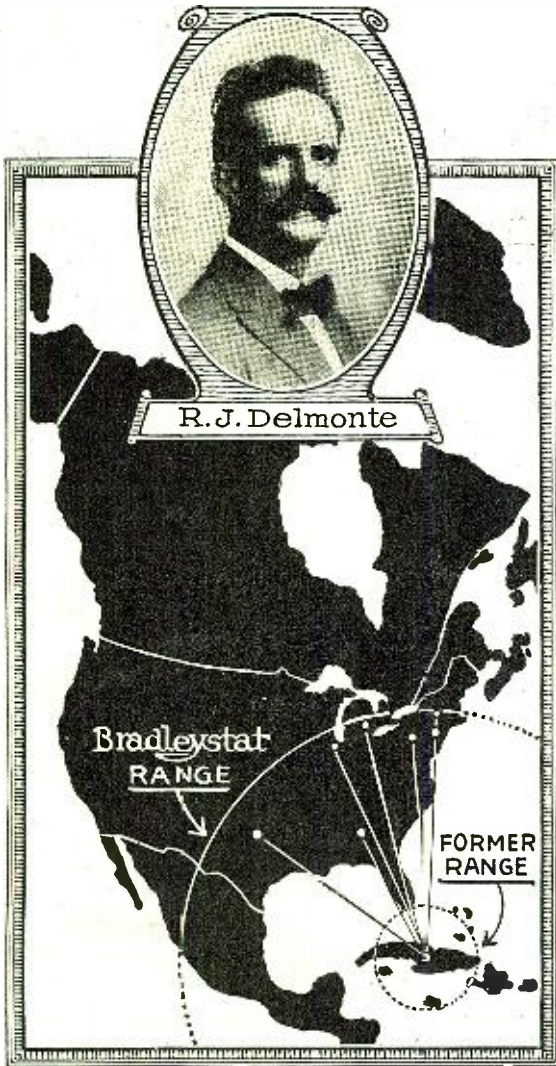

## The Universal Bradleystat

provides perfect, stepless, noiseless filament control for every tube on the radio market. Try any tube with the Universal Bradleystat.

Retail Price

**\$1.85**

P. P. 10c extra



Guaranteed  
for one year

Remarkable improvement in radio reception follows installation of Bradleystats and amazes experimenter in Tropics. Read his letter!

Camaguey, Cuba, July 17th, 1923

"My experimental room is located in the center of Cuba, amidst the Gulf, which is reputed to be the general headquarters of static and all atmospheric disturbances of the whole universe.

I had my sets equipped with wire rheostats having vernier adjustments and my radius of reception was 350 miles from Havana with imperfect reception from Atlanta, Georgia.

After installing Bradleystats, I increased the radius 1000 miles without distortion and picked up Detroit, Schenectady, Pittsburgh, Fort Worth and other stations. When static is performing one of its infernal displays, I lower the filament heat with the Bradleystat to reduce noises. There is only one point of filament heat where this condition is fulfilled and the wire rheostat cannot furnish this with critical detector tubes.

For this reason, I claim the Bradleystat is the only apparatus for controlling filament heat, and if proper adjustment is made, static noises are practically eliminated.

Yours very truly,

## Beware of Imitations—Avoid Substitutes

Numerous attempts have been made, without success, to duplicate Bradleystat performance by using carbon powder in tubes and other containers instead of the scientifically-prepared graphite discs found only in the genuine Bradleystat. For perfect filament control and uninterrupted performance, be sure to ask for the Bradleystat. The name Bradleystat is embossed on the porcelain container for your protection.

**Allen-Bradley Co.**  
Electric Controlling Apparatus

287 Greenfield Ave.

Milwaukee, Wis.

THE ALLEN-BRADLEY CO. HAS BUILT GRAPHITE DISC RHEOSTATS FOR OVER TWENTY YEARS

THE PERIODICAL PRESS, NEW YORK

# What Radio Problems Have You?

You'll Find the Answer In This New Book

## Radio Questions Answered

By A. P. PECK, A.M.I.R.E.

Radio Editor, SCIENCE & INVENTION

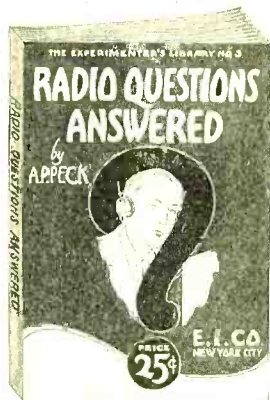

This book will prove as welcome to the radio public as our "100 Radio Hook-ups", which is now the fastest selling radio publication on the market. "Radio Questions Answered" was gotten up after a thorough canvass of dealers to find out which topics troubled most of the amateurs. Almost 100 questions are answered very fully and in language so simple that even the most inexperienced layman can easily understand. Put up in the style which has made the E. I. books famous all over the world.

52 pages, 2 Color Cover, 25 Illustrations

25c

## 100 Radio Hook-ups

By M. L. MUHLEMAN

A book for both the novice and advanced radio amateur containing a varied selection of hook-ups from the simple crystal to the more elaborate circuits, with a circuit for every requirement. Crystal hook-ups, combined crystal with radio and audio frequency amplifiers, non-regenerative, and regenerative vacuum tube circuits with and without radio and audio amplifiers. Amplifier units, with straight jacks, filament and switching arrangements, power amplifiers, choke coil, resistance coupled and transformer coupled radio frequency amplifiers.

Includes all of the latest one and multi-tube hook-ups including the numerous types of Reflex, super-regenerative, super-Heterodyne, Neutrodyne, Reinartz, Flewelling, and Bishop. The values and constants of all apparatus employed in the hook-ups are given. A list of radio symbols is included, which is of material help to the reader in determining the meaning of the conventional hook-up diagrams. The text includes much helpful information.

52 Pages—Two-Color Cover

25c



This book covers in comprehensive form the fundamental principles of tuning. The characteristics of radio waves are fully described and illustrated. Illustrations are used so that the non-technical reader can easily understand the identical actions as applied to radio. Several chapters are devoted to the use and functions of all radio apparatus. The book describes how to tune such sets as the Reinartz, Flewelling, Neutrodyne, radio frequency amplifier receivers and others.

52 pages,  
25 Illustrations

Prepaid ..... 25c

A non-technical book for the beginner. Gives complete constructional data on the building of a complete Crystal Detector Set, Tuning Coil, Loose Coupler and a Single Audion Tube Set with Amplifying Units. It furnishes all dimensions and working drawings of every part that must be constructed by the amateur. Written in plain, simple language that anyone can understand. The opening chapter gives a complete description of the theory of radio and tells what it's all about, teaching the principles of wireless so that the constructor knows what he is doing.

48 Pages, 26 Illustrations  
Bound in Beautiful Two-Color Cover. Size, 5 1/2

x 7 1/2 in. Prepaid ..... 25c

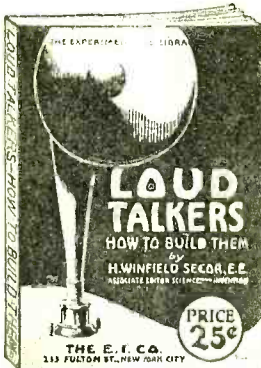
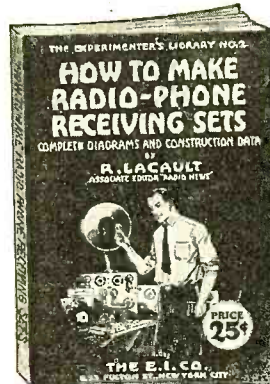

This book describes and gives complete data for building two distinct types of loud talkers. One chapter deals with improvised loud talkers, and gives complete instructions on how to build suitable horns for use in loud receivers of the Baldwin and other types. In preparing these designs, the point has been constantly kept in mind to use the simplest parts possible, so that anyone can build a successful loud talker, equivalent to the commercial types, costing \$40.00 or more.

48 pages, Profusely  
Illustrated

Prepaid ..... 25c

This book is for the more advanced amateur, showing the construction of the Radio Frequency Amplifying Transformer and giving complete constructional data. It shows the application of Radio Frequency to amplifying units that the amateur may already possess and gives 15 hook-ups showing practically every use Radio Frequency Amplifying Transformers can be put to.

32 Pages, 15 Illustrations  
Bound in Beautiful Two-Color Cover. Size, 5 1/2

x 7 1/2 in. Prepaid ..... 25c

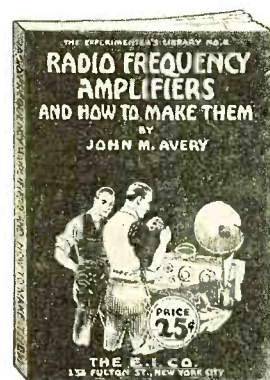

If your dealer cannot supply you—order direct from us—giving dealer's name and address.

THE E. I. COMPANY (THE CONSRAD CO.) 233 Fulton St., N. Y. City  
Selling Agents

**Radiotron WD-12**  
The standard  
base dry cell tube  
\$6.50

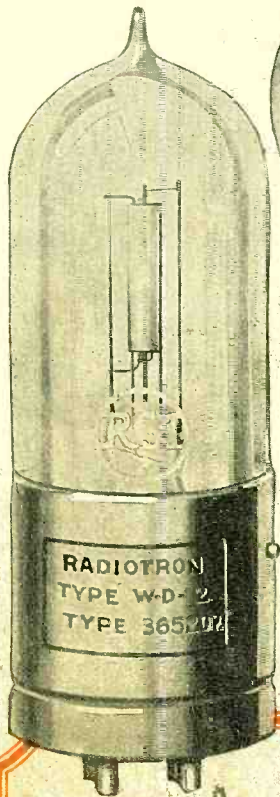

**Radiotron  
UV-201-A**  
The super-  
amplifier  
tube \$6.50

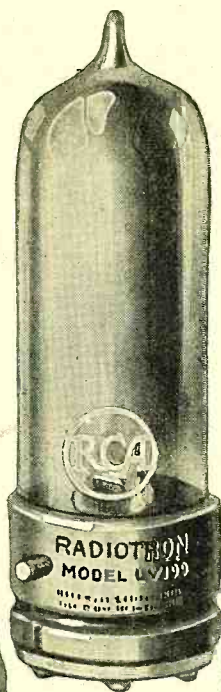

**Radiotron  
UV-199**  
The little tube of  
big performance  
\$6.50



**Radiotron  
UV-200**  
The long  
distance  
detector  
\$5.00

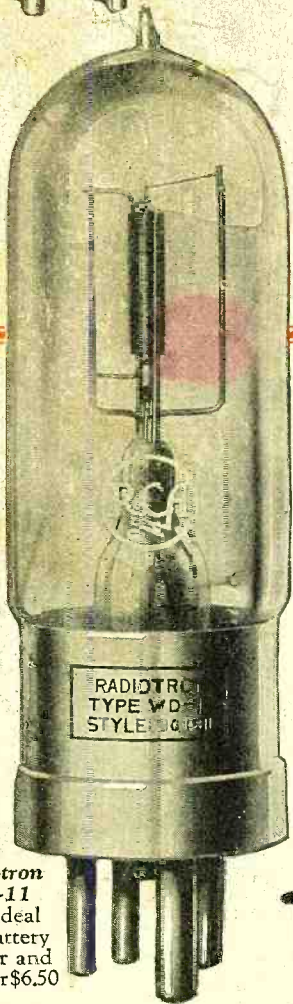

**Radiotron  
WD-11**  
The ideal  
dry battery  
detector and  
amplifier \$6.50

**3,600,000  
Radiotrons/  
already made and sold!**

This one fact reveals at a glance the growth of radio! 3,600,000 RADIOTRONS already sold! It was the perfection of the RADIOTRON that made popularization of radio possible—and every vacuum tube set needs RADIOTRONS for clear reception and amplification—for sensitivity—and long distance reception.

RADIOTRONS were developed in the world's largest radio laboratories, where hundreds of modern radio achievements had their beginnings. There, they have been steadily perfected to give ever greater service. And now RADIOTRONS have been developed to meet new needs of both transmission and reception. When you ask for a RADIOTRON, take a good look to be sure the name is on it—and the trade mark!

This symbol  
of quality  
is your pro-  
tection



**Radio Corporation of America**

Sales Dept., Suite 2065: 233 Broadway, New York  
District Sales Offices:

10 South LaSalle Street, Chicago, Ill.

433 California Street, San Francisco, Cal.

**Radiotrons**